

Murata Products for Automotive



Cars and the Future

An indispensable element in an “omnipresent network society” – Murata technology links people and the ever-evolving automobile.



Ever-evolving automotive technology is no longer confined to the basic vehicle functions of propulsion, steering, and braking. It is now expanding into a variety of disciplines. Remarkable advances in automotive technology, most notably in areas such as telematics, advanced safety features, and environmental compatibility, have led to tremendous evolution in our vehicles and our automotive society since the days when vehicles were merely a means of getting around.

This evolution has been facilitated by electronic components that monitor the vehicle inside and out and exchange information among the components. Murata produces components that are so small and light you wouldn't even notice them on your fingertip and sensors and modules made of materials we have engineered at the molecular level. We are staking our future potential and the boundless development of automobiles on these small electronic components. With our technology and know-how, Murata will contribute to developing a “ubiquitous network society” preserving the global environment, and creating a future with safer and more comfortable automobiles.

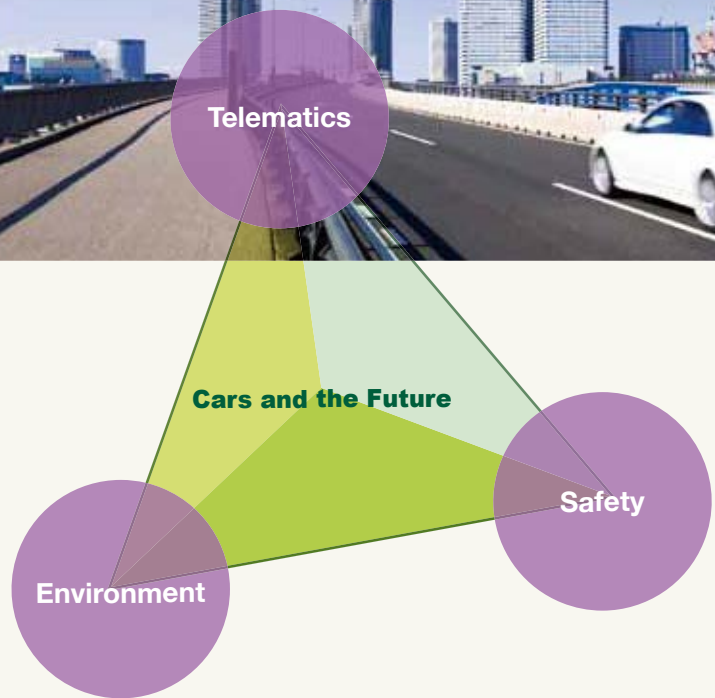

Index

Cars and the Future	01-02
Work in Automotive	03-04
Circuit Applications	05-06
Specific Use Products Lineup	07-09
Products Lineup	10-20
Corporate Activities	21-22

<http://www.murata.com/en-global/apps/auto>

For Safety

Murata's sensing technology – protecting both people and cars.

Sensing technology provides precision control by electronics, which is essential for the safety systems of vehicles. Murata's electronic components, including various sensors, support a pleasant driving experience with excellent performance by the latest technology and high reliability that can only be provided by ceramics, which can endure severe operating conditions.

3D Autonomous Nervous Structure

This is a sensing technology that promotes improvements in the safety functions and intelligence of vehicles. Only Murata's 3D MEMS technology can provide a reduction of the cross axis, improving reliability of linearity.

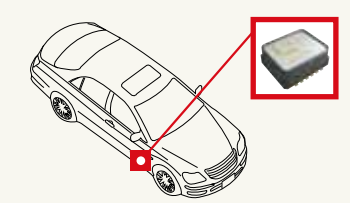

MEMS Acceleration Sensor
 ■For ESC Acceleration Detection
 Excellent temperature drift characteristic. Compliant to Quality Standard AEC-Q100 for automobiles.

For the Environment

The next generation performance – providing cars for the earth's environment.

Consideration of the global environment is important for the automobile industry. Murata helps reduce CO₂ and conserve energy by developing and supplying electronic components that take advantage of such characteristics of ceramics as compactness and thermal resistance. We are helping to expand the market share of environmentally friendly vehicles such as electric vehicles (EVs) and hybrid electric vehicles (HEVs).

Intelligent Power Solution

Murata's unique "smart" power supply provides amazing value by combining intelligent energy saving features and high power output in an ultra-small package.

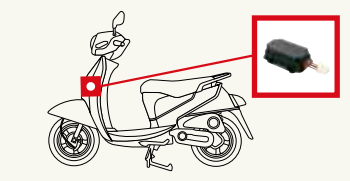

DC-DC Converter for E-Bike
 ■For E-bike auxiliary drive
 Highly efficient
 Non-isolated type
 Small (palm sized) module & lightweight
 Conforms to IP56 for dust and water ingress

Murata contributes to the development of mobile communication systems with the technology and know-how we developed for the information communication equipment market and with the high reliability that comes with the outstanding heat and vibration resistance typical of our ceramic components. Automotive telematics achieves the combining of a radio transmission system with the car navigation and security system. Murata's information communication technology is also playing an active role in making such new systems prevalent.

Network on Wheels

Various wireless communication standards are used for information and communications in vehicles. Murata offers a highly reliable connectivity module, making full use of the excellent high frequency portion and high frequency circuit technology.

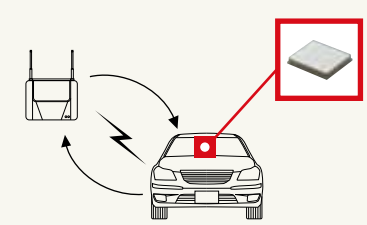

Connectivity Module
 ■On-board Communication Module for Automobiles
 Murata has achieved the wireless communication functions required for on-board communications with compact modules, such as Bluetooth®, Wi-Fi®, GPS, FM and others.

Bluetooth is a registered trademark of Bluetooth SIG, Inc. of the United States. Wi-Fi is a registered trademark or trademark of Wi-Fi Alliance.

Work in Automotive

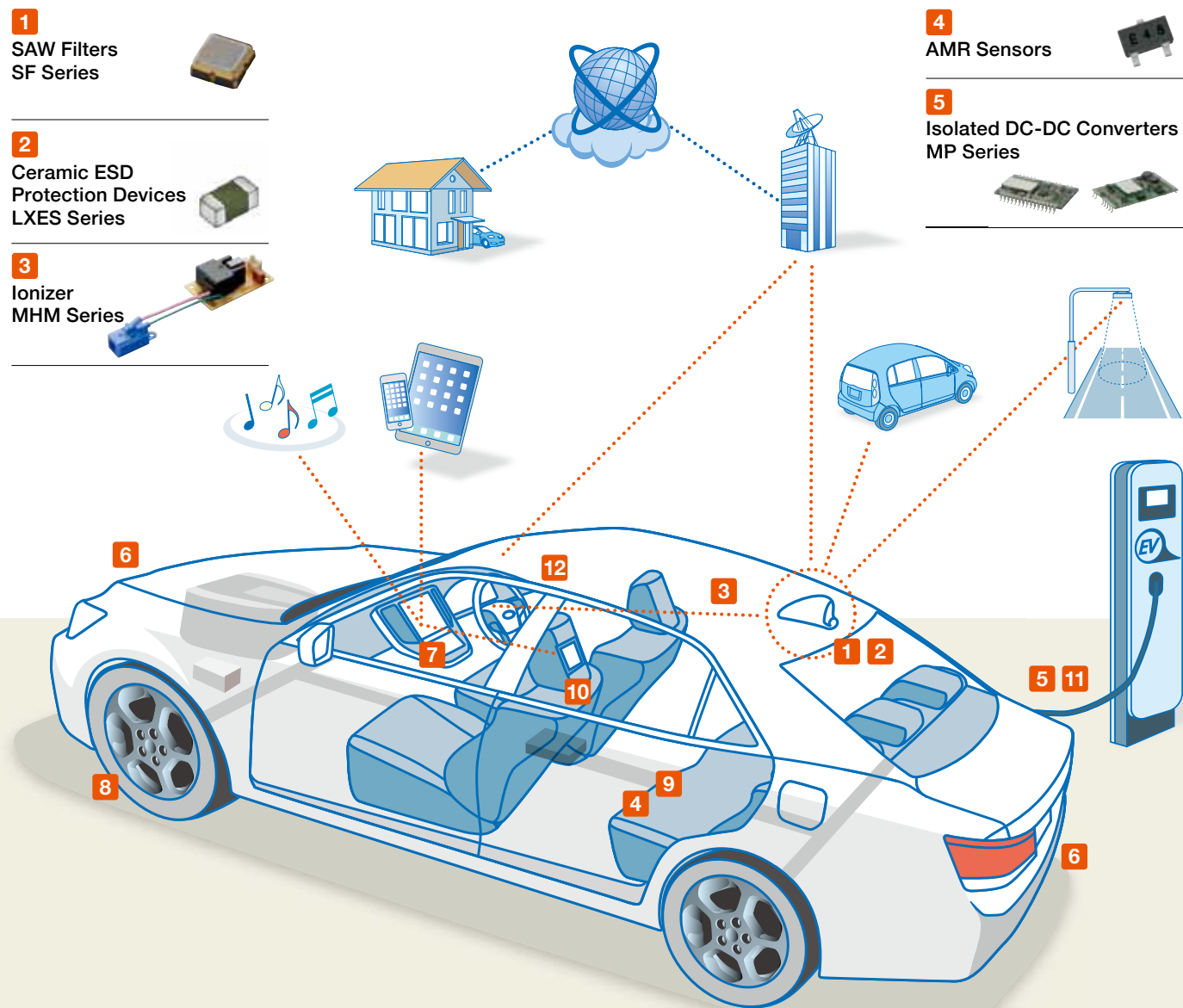

- 1** SAW Filters SF Series
- 2** Ceramic ESD Protection Devices LXES Series
- 3** Ionizer MHM Series

- 4** AMR Sensors
- 5** Isolated DC-DC Converters MP Series

- 6** Ultrasonic Sensors MA Series
- 7** Wi-Fi® · Bluetooth® Connectivity Modules
- 8** Shock Sensors PKGS Series
- 9** Antenna Coils MSA Series
- 10** Wi-Fi® Modules
- 11** Safety Standard Certified Ceramic Capacitors DE6 Series
- 12** Ultrasonic Sensors Open Structure Type MA Series

- PTC Thermistors PRF Series
- Trimmer Capacitors TZY2 Series
- Chip Monolithic Capacitors
- Ferrite Cores
- EMI Suppression Filters BLM Series
- EMI Suppression Filters NFM Series
- Piezoelectric Sounders PK Series
- Rotary Position Sensors SV01 Series

Infotainment



- Multilayer LC Filters LF_V Series
- DC-DC Converters MP Series
- RF Inductors LQW/LQG Series
- Polymer Aluminum Electrolytic Capacitors ECAS Series

Comfort/In Vehicle LAN



- Ceramic Filters SFECF Series
- Common Mode Choke Coils DLW Series
- Crystal Units XRCHA_F_A Series
- Ceramic Resonators CERALOCK® CSTCE/CSTCR Series
- DC-DC Converters H8 Series
- Electrical Double Layer Capacitors DMT Series

Powertrain

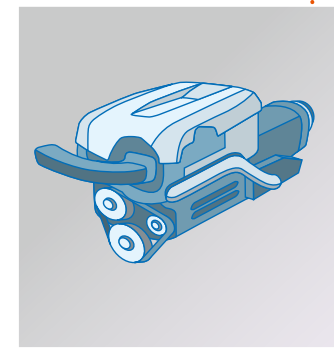

- Metal Terminal Capacitors KCM/KC3 Series
- Lead Type Ceramic Capacitors RHE Series 150°C Compatible Type
- Ceramic Functional Substrates LFC®
- Common Mode Choke Coils PLT10H Series

Safety

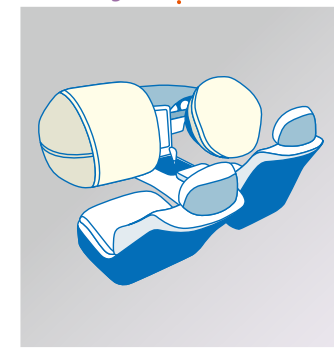

- Acceleration Sensors SCA Series
- Combo Sensors SCC Series
- Ceramic Functional Substrates LFC®

Circuit Applications

PIM (Power Inverter Module)

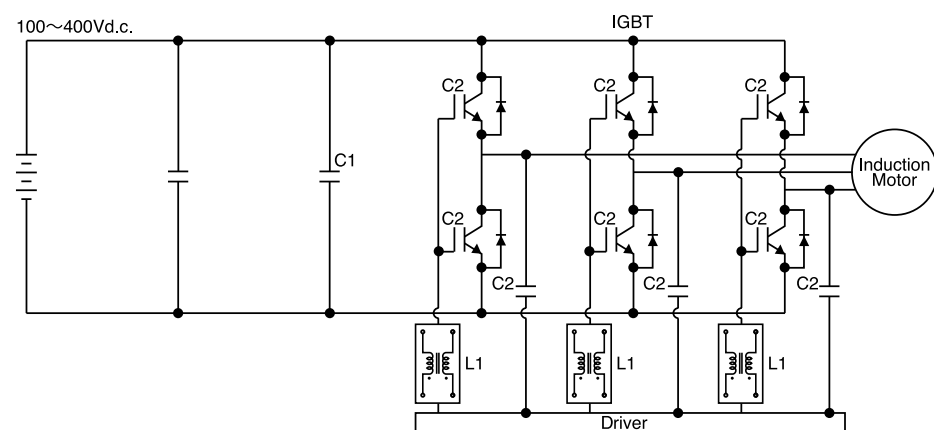

IVI (In Vehicle Infotainment)

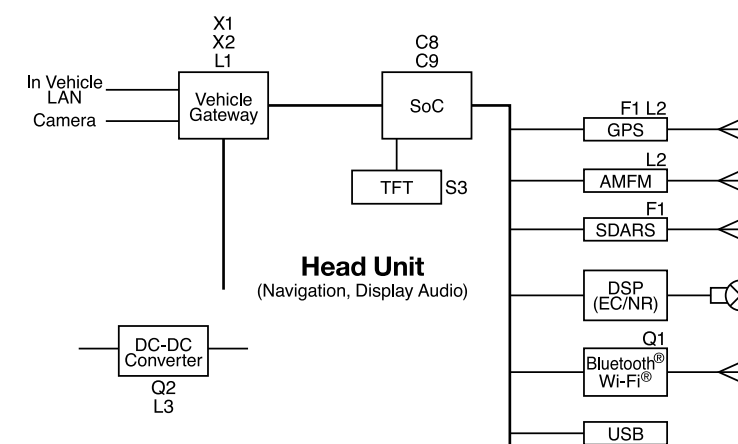

BMS (Battery Management System)

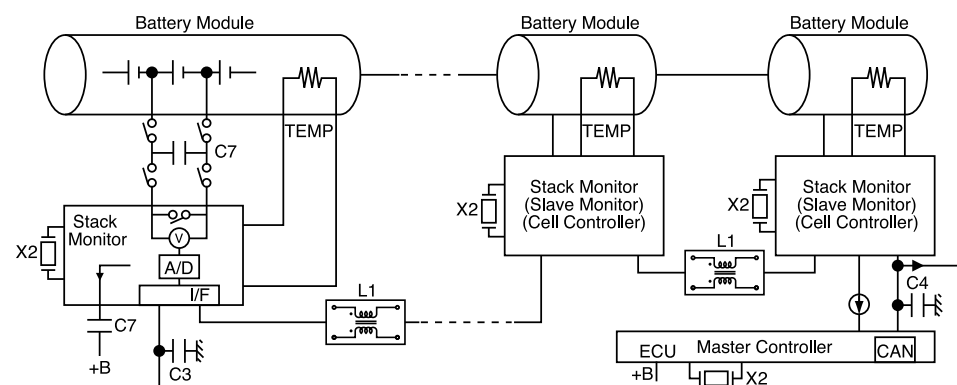

Airbag Combined Stability Controller

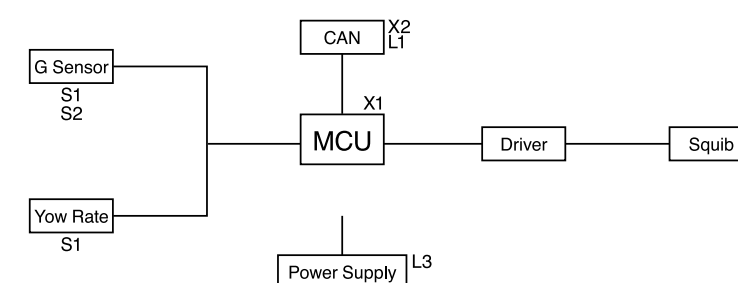

OBC (On Board Charger)

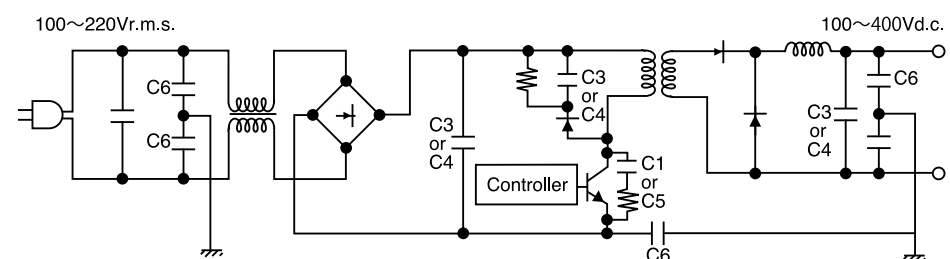

C1	Metal Terminal Monolithic Ceramic Capacitors (for 250V or more)	KC3 Series/X7T
C2	Chip Monolithic Ceramic Capacitors (for 250V or more)	GCM Series/U2J
C3	Chip Monolithic Ceramic Capacitors (Soft Termination Type)	GCJ Series/X7R
C4	Metal Terminal Monolithic Ceramic Capacitors	KCM Series/X7R
C5	Chip Monolithic Ceramic Capacitors (High Allowable Ripple Current Type)	GC3 Series/X7T
C6	Safety Standard Certified Ceramic Capacitors	DE6 Series
C7	Chip Monolithic Ceramic Capacitors	GCM Series
C8	Low ESL Ceramic Capacitors	LL Series
C9	3-Terminal Capacitors	NFM Series
F1	SAW Filters	SF Series
L1	Chip Common Mode Choke Coils	DLW Series
L2	RF Inductors	LQP/LQG/LQW Series
L3	Inductors for Power Lines	LQM/LQH Series
Q1	Connectivity Modules	LBW Series
Q2	DC-DC Converters	MP Series
S1	Combined Gyroscopes and Accelerometers	SCC Series
S2	Accelerometers	SCA Series
S3	Rotary Position Sensors	SV01 Series
X1	Crystal Units	XRCHA-F-A Series
X2	Ceramic Resonators (CERALOCK®)	CSTCR/CSTCE Series

Specific Use Products Lineup

Powertrain

Isolated Type DC-DC Converters

For Battery Management System of PHEV/HEV Solutions requiring smaller size and lighter weight, Murata provides custom high reliability, high efficiency and low noise emission isolated multi-output DC-DC Converters.



Lead Type Ceramic Capacitors

This is an IEC60384-14 Class X1/Y2 certified product (basic insulation). The X1, Y2 class products satisfy the safety standards of UL/ENEC (VDE).



Series	TC Code	D (mm)	Rated Voltage (V)	Capacitance Range (F)											Operating Temperature Range (°C)			
				0.1p	1p	10p	100p	1000p	0.01μ	0.1μ	1μ	10μ	100μ	1000μ				
DE6B3	B	8 to 9	AC300 (r.m.s.)					100pF-680pF										-40 to +125
DE6E3	E	7 to 12	AC300 (r.m.s.)					1000pF-4700pF										-40 to +125

Safety

Ultrasonic Sensors

Measures the distance between the car and the object behind it when backing up to park. Has a flat orientation, being wide horizontally and narrow vertically.



Series	Type	Using Method	Nominal Frequency (kHz)	Sensitivity (dB)	Sound Pressure Level (dB)	Directivity (deg.)	Size (mm)
MA40MF14-0N,0B	Drip Proof Type	Dual Use	40	-87 min.	103 min.	110°x50° typ.	ø14

Series	Type	Using Method	Nominal Frequency (kHz)	Capacitance (pF)	Overall Sensitivity (Vop)	Directivity (deg.)	Size (mm)
MA58AF14-0N,0B	Drip Proof Type	Dual Use	58	1400 typ.	2.0 typ.	75°x35° typ.	ø14

The detection distance and resolution vary according to the circuit to be used.

Shock Sensors

Used to detect tire revolutions to save battery power in TPMS.



Series	Inclination Angle of Primary Axis (deg.)	Electric Charge Sensitivity	Insulation Resistance (MΩ)	Resonant Frequency (kHz)	Capacitance (pF)	Operating Temperature Range (°C)	Size (mm)
PKGS-25TA-R	25	0.205pC/G	500 min.	39 typ.	240	-40 to +125	4.8x2.3x1.3
PKGS-00TAV-R	0	0.80mV/G	500 min.	39 typ.	245		
PKGS-45TAV-R1	45	0.77mV/G	500 min.	37 typ.	195		

Combined Gyro Sensors and Accelerometers

Murata is the market leading manufacturer and supplier of sensitive (low-g) acceleration and inclination sensors to the global automotive industry. We are the pioneer in the active application of silicon sensor technology to road safety.



Combined Gyro Sensors and Accelerometers

Series	No. of Axis	Range	Supply Voltage	Temperature Range	Sensitivity	Signal Bandwidth	Output Type	Typical Applications
SCC1300	1-Axis Gyro 3-Axis Accelerometer	±100°/s, ±2.0g	5V Analog	-40 to +125°C	50LSB/(°/s), 1800LSB/g	50Hz, 45Hz	Digital/SPI	Platform Stabilization Motion Analysis and Control Guidance and Navigation Systems
		±300°/s, ±6.0g	3.3V Digital		18LSB/(°/s), 650LSB/g			
SCR1100	1-Axis Gyro	±100°/s	5V Analog	-40 to +125°C	50LSB/(°/s)	50Hz	Digital/SPI	
		±300°/s	3.3V Digital		18LSB/(°/s)			

Accelerometers

Series	No. of Axis	Range	Supply Voltage	Temperature Range	Sensitivity	Signal Bandwidth	Output Type	Typical Applications
SCA600	1	±1.5 to ±12.3g	5V	-40 to +125°C	0.15 to 2V/g	50 to 400Hz	Analog	Automotive Safety Critical Applications, IMU, Industrial Applications
SCA800	1	±2g	3.3V	-40 to +125°C	900LSB/g	50Hz	Digital/SPI	
SCA1000	2	±1.7g	5V	-40 to +125°C	1.2V/g	50Hz	Analog/Digital	
		±4g			0.55V/g	115Hz		
SCA2100	2	±2g	3.3V	-40 to +125°C	900LSB/g	45Hz	Digital/SPI	
SCA3100	3	±2g	3.3V	-40 to +125°C	900LSB/g	45Hz	Digital/SPI	
		±6g			650LSB/g			
SCA100T	2	±12g	5V	-40 to +125°C	0.17V/g	400Hz	Analog/Digital	

Infotainment

SAW Filters

E (3.0x3.0mm), G (2.5x2.0mm), H (2.0x1.6mm) packages



Series	Center Frequency	IL Typ (dB)	BW (MHz)	Package Size (mm)	Comments	Status
SF1186B-2	1575.42 MHz	2.68	2	3.0x3.0 6 Pin Single Ended	GPS	MP
SF1186G	1575.42 MHz	1.5	2	2.5x2.0 4 Pin Single Ended	GPS	MP
SF1186H-2	1575.42 MHz	1.15	2	2.0x1.6 4 Pin Single Ended	GPS	MP
SF1186H-3	1575.42 MHz	1.15	2	2.0x1.6 4 Pin Single Ended	GPS 105 °C	MP
SF2353E	1582.4 MHz	2.10	46.61	3.0x3.0 6 Pin Single Ended	GPS/Glonass	MP

Products Lineup

Connectivity Modules

This product can be used for communication in Bluetooth®, Wi-Fi®, GPS, FM and others.
One stop solution of multimedia environment in the automotive.



Chip Multilayer LC Filters (Available for consumer grade use only.)

Ultra-small and low-profile filters based on ceramic multilayer technology.

Band Pass Filters

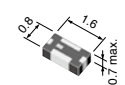

LFB18_V Series

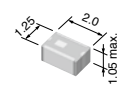

LFB21_V Series

(in mm)

Low Pass Filters

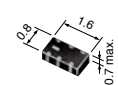

LFL18_V Series

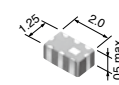

LFL21_V Series

(in mm)

Chip Multilayer Baluns (Available for consumer grade use only.)

SMD baluns constructed with a copper conductor and ceramic material.
Ideal for high-frequency applications. Small-size and low-loss baluns
can be customized for balance impedance of 50Ω to 200Ω.

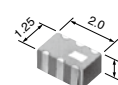

LDB21_V Series



LDM18_V Series

(in mm)

Chip Multilayer Hybrid Dividers (Available for consumer grade use only.)

Power divider with a multilayer low pass filter in an ultra-compact package.

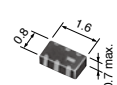

LDD18_V Series

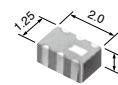

LDD21_V Series

(in mm)

Chip Multilayer Couplers (Available for consumer grade use only.)

An ultra-small, low-profile directional coupler based on ceramic multilayer technology.
This coupler achieves ultra-small size, low insertion loss and high isolation.



LDC18_V Series

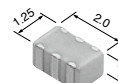

LDC21_V Series

(in mm)

DC-DC Converters

Murata provides custom DC-DC Converters designed for power supply of Navigation System,
Audio System, DVD and HDD.



Cars and the Future



Capacitors

Application Matrix

Product Name		Series	Powertrain	Safety	Comfort	Infotainment
MLCC	General Purpose Products for Automotive	GCM	●	●	●	●
	For General Purpose (Infotainment/Comfort)	GRM			●	●
	Products Based on the Electrical Appliance and Material Safety Law of Japan	GA2			●	●
	Safety Standard Certified Type	GA3			●	●
	High Effective Capacitance & High Allowable Ripple Current	GC3	●	●	●	●
	Specially Designed Product to Reduce Shorts	GCD	●	●	●	●
	Specially Designed Product to Reduce Shorts & Resin Electrode Products	GCE	●	●	●	●
	Conductivity Adhesive Compatible Type	GCG	●	●	●	●
	Resin External Electrode Products	GCJ	●	●	●	●
	High Frequency High Q Type 1005(in mm)/0402(in inch) Size Max.	GJM			●	●
	Top & Bottom Electrode Type for Bonding	GMA			●	●
	Compatible to Bonding/AuSn Soldering	GMD			●	●
	High Frequency High Q Type 1608(in mm)/0603(in inch) Size Min.	GQM			●	●
	High Effective Capacitance & High Allowable Ripple Current	GR3			●	●
	For Ethernet LAN & Primary-secondary Coupling of DC-DC Converters	GR4			●	●
	Resin External Electrode Type	GRJ			●	●
	Metal Terminal Type/High Effective Capacitance & High Allowable Ripple Current for Automotive	KC3	●	●	●	●
	Metal Terminal Type for Automotive	KCM	●	●	●	●
	Metal Terminal Type High Effective Capacitance & High Allowable Ripple Current for General Purpose	KR3			●	●
	Metal Terminal Type for General Purpose (Infotainment/Comfort)	KRM			●	●
Lead Type	8-Terminal Low ESL Type	LLA			●	●
	LW Reversed Low ESL Type	LLL			●	●
	10-Terminal Low ESL Type	LLM			●	●
	ESR Controlled Low ESL Type	LLR			●	●
	Safety Standard Certified (IEC60384-14 Class X1/Y1)	DE1			●	●
	Safety Standard Certified (IEC60384-14 Class X1/Y2)	DE2			●	●
	Safety Standard Certified (IEC60384-14 Class X1/Y2 for Automotive)	DE6	●	●	●	●
	High Voltage (Class 1 (Char. SL) DC1-3.15kV Rated)	DEA			●	●
	High Voltage (Class 2 DC1-3.15kV Rated)	DEB			●	●
	High Voltage (Class 1, 2 DC6.3kV Rated)	DEC			●	●
	High Voltage (LCD Backlight Inverter Circuit)	DEF			●	●
	High Voltage (High Temperature Guaranteed, Low-dissipation Factor (Char. R, C)	DEH			●	●
	Based on the Electrical Appliance and Material Safety Law of Japan	DEJ			●	●
High Voltage (High Temperature Guaranteed, Low-dissipation Factor (Char. D)	DES			●	●	
Ultrahigh Voltage	DHR			●	●	
125°C Compatible Type for Automotive	RCE	●	●	●	●	
Monolithic Lead Type for Consumer Market	RDE			●	●	
150°C Compatible Type for Automotive	RHE	●	●	●	●	
Polymer Aluminum Electrolytic Capacitors	ECAS			●	●	
Electrical Double Layer Capacitors	DMT			●	●	
Trimmer Capacitors	TZ			●	●	

Continued on the following page.

Chip Monolithic Ceramic Capacitors/Lead Type Ceramic Capacitors

Powertrain/Safety

Series	Series Name	Characteristics	Rated Voltage		Capacitance			
			V	kV	pF		μF	
			1 10 100 1 10	0.1 1 10 100 1000 10000 0.1 1 10 100 1000				
GCM	General Purpose Products for Automotive	AEC-Q200	6.3Vdc-1000Vdc		1.0pF-47μF			
GCD	Specially Designed Product to Reduce Shorts	AEC-Q200 Fail safe Deflecting crack	25Vdc-100Vdc		1000pF-0.10μF			
GCE	Specially Designed Product to Reduce Shorts & Resin Electrode Products	AEC-Q200 Fail safe Deflecting crack	25Vdc-100Vdc		1000pF-0.10μF			
GCG	Conductivity Adhesive Compatible Type	AEC-Q200 Deflecting crack Soldering crack	16Vdc-100Vdc		10pF-10μF			
GCJ	Resin External Electrode Products	AEC-Q200 Fail safe Deflecting crack	6.3Vdc-1000Vdc		220pF-47μF			
GC3	High Effective Capacitance & High Allowable Ripple Current	AEC-Q200 Anti-noise	250Vdc-630Vdc		10000pF-1.0μF			
KCM	Metal Terminal Type for Automotive	AEC-Q200 Anti-noise Deflecting crack Soldering crack	25Vdc-100Vdc		4.7μF-68μF			
KC3	Metal Terminal Type/High Effective Capacitance & High Allowable Ripple Current for Automotive	AEC-Q200 Anti-noise Deflecting crack Soldering crack	250Vdc-630Vdc		0.10μF-2.2μF			
DE6	Safety Standard Certified (IEC60384-14 Class X1/Y2 for Automotive)	AEC-Q200 Safety standard	300Vac (r.m.s.)		100pF-4700pF			
RCE	125°C Compatible Type for Automotive	AEC-Q200	25Vdc-1000Vdc		1.0pF-22μF			
RHE	150°C Compatible Type for Automotive	AEC-Q200	50Vdc-100Vdc		100pF-10μF			

Infotainment/Comfort

Series	Series Name	Characteristics	Rated Voltage		Capacitance			
			V	kV	pF		μF	
			1 10 100 1 10	0.1 1 10 100 1000 10000 0.1 1 10 100 1000				
GRM	For General Purpose (Infotainment/Comfort)		2.5Vdc-3150Vdc		0.10pF-100μF			
GA2	Products Based on the Electrical Appliance and Material Safety Law of Japan		250Vac		470pF-0.10μF			
GA3	Safety Standard Certified Type		250Vac		10pF-56000pF			
GJM	High Frequency High Q Type 1005(in mm)/0402(in inch) Size Max.	High Q	25Vdc-50Vdc		0.10pF-47pF			
GMA	Top & Bottom Electrode Type for Bonding		6.3Vdc-100Vdc		100pF-0.47μF			
GMD	Compatible to Bonding/AuSn Soldering		6.3Vdc-50Vdc		100pF-0.47μF			
GQM	High Frequency High Q Type 1608(in mm)/0603(in inch) Size Min.	High Q	50Vdc-500Vdc		0.10pF-100pF			
GR3	High Effective Capacitance & High Allowable Ripple Current	Anti-noise	250Vdc-630Vdc		10000pF-1.0μF			
GR4	For Ethernet LAN & Primary-secondary Coupling of DC-DC Converters		2000Vdc		100pF-10000pF			
GRJ	Resin External Electrode Type	Deflecting crack	6.3Vdc-1000Vdc		470pF-47μF			
KR3	Metal Terminal Type High Effective Capacitance & High Allowable Ripple Current for General Purpose	Anti-noise Deflecting crack Soldering crack	250Vdc-630Vdc		0.10μF-2.2μF			
KRM	Metal Terminal Type for General Purpose (Infotainment/Comfort)	Anti-noise Deflecting crack Soldering crack	25Vdc-1000Vdc		68000pF-68μF			

Continued on the following page.

Series	Series Name	Characteristics	Rated Voltage		Capacitance			
			V	kV	pF		μF	
			1 10 100 1 10	0.1 1 10 100 1000 10000 0.1 1 10 100 1000				
LLA	8-Terminal Low ESL Type	Low ESL	4Vdc-25Vdc		10000pF-4.7μF			
LLL	LW Reversed Low ESL Type	Low ESL	4Vdc-50Vdc		2200pF-10μF			
LLM	10-Terminal Low ESL Type	Low ESL	4Vdc-16Vdc		0.10μF-2.2μF			
LLR	ESR Controlled Low ESL Type	Low ESL	4Vdc		1.0μF			
DE1	Safety Standard Certified (IEC60384-14 Class X1/Y1)		250Vac (r.m.s.)-300Vac (r.m.s.)		10pF-4700pF			
DE2	Safety Standard Certified (IEC60384-14 Class X1/Y2)		250Vac (r.m.s.)-300Vac (r.m.s.)		10pF-10000pF			
DEA	High Voltage (Class 1 (Char. SL) DC1-3.15kV Rated)		1000Vdc-3150Vdc		10pF-560pF			
DEB	High Voltage (Class 2 DC1-3.15kV Rated)		1000Vdc-3150Vdc		100pF-10000pF			
DEC	High Voltage (Class 1, 2 DC6.3kV Rated)		6300Vdc		10pF-2200pF			
DEF	High Voltage (LCD Backlight Inverter Circuit)		6300Vdc (p-p)		2.0pF-47pF			
DEH	High Voltage (High Temperature Guaranteed, Low-dissipation Factor (Char. R, C))		500Vdc-3150Vdc		150pF-4700pF			
DEJ	Based on the Electrical Appliance and Material Safety Law of Japan		250Vac (r.m.s.)		1000pF-10000pF			
DES	High Voltage (High Temperature Guaranteed, Low-dissipation Factor (Char. D))		500Vdc-1000Vdc		100pF-4700pF			
DHR	Ultrahigh Voltage	Ultrahigh-voltage Deflecting crack Soldering crack	10kVdc-15kVdc		100pF-1000pF			
RDE	Monolithic Lead Type for Consumer Market	Anti-noise Deflecting crack Soldering crack	25Vdc-1000Vdc		1.0pF-47μF			

Explanation of Symbols

- AEC-Q200 compliant product
- Low dissipation for high frequency
- Product with solder cracking suppression
- Product suitable for acoustic noise reduction and low distortion
- Low inductance
- Withstands voltage of 10-40kV
- Fail safe product
- Product resistant to deflection cracking
- Certified by safety standard

Polymer Aluminum Electrolytic Capacitors

Infotainment/Comfort

Series	L×W	Characteristics	Rated Voltage		Capacitance			
			V	kV	pF		μF	
			1 10 100 1 10	0.1 1 10 100 1000 10000 0.1 1 10 100 1000				
ECAS	7.3×4.3mm	Large Cap Effective Cap	2Vdc-16Vdc		6.8μF-560μF			

Explanation of Symbols

- Over 220μF
- No DC bias characteristics

Continued on the following page.

Electrical Double Layer Capacitors



Comfort

Series	Rated Voltage (V)	Nominal Capacitance (mF) (): Tolerance	ESR@1kHz (mΩ)	Size (mm)	Operating Temperature (°C)
DMT 	4.2	470 (±20%)	130	21.0X14.0X3.5	-40 to +85

Optimal for peak power assist during wireless communication for RKE.

Trimmer Capacitors

Infotainment/Comfort

Series	Type	Size (mm)	The Number of Product	Rated Voltage (Vdc)	Variable Range (pF)			
					0.1	1	10	100
TZY2_AC01 	SMD	2.5X3.2X1.25	8	25		0.6pF-45pF		
TZB4 	SMD	4.0X4.5X3.0	8	100		1.4pF-50pF		

Noise Suppression Products

Application Matrix

Product Name	Series	Powertrain	Safety	Comfort	Infotainment
Chip Ferrite Beads	BLM	●	●	●	●
Chip EMIFIL®	NFM	●	●	●	●
	NFL			●	●
	NFE	●	●	●	●
	NFZ			●	●
Block Type EMIFIL®	BNX	●	●	●	●
Chip Common Mode Choke Coils	DLW	●	●	●	●
	DLM			●	●
Common Mode Choke Coils	PLT	●	●	●	●
EMIGARD® (EMIFIL® with Varistor Function)	VFC	●	●	●	●
Disc Type EMIFIL®	DSS			●	●
Ferrite Cores	FS			●	●

EMI Suppression Filters

Powertrain/Safety

BL□ Inductor Type	Series	Size Code in inch (in mm)	Impedance (Ω) at 100MHz	Effective Frequency Range (Applicable Frequency Ranges are only for reference.)							
				10kHz	100kHz	1MHz	10MHz	100MHz	1GHz	10GHz	
For General Band Noise	For General Signal Lines	BLM_AG	0402-0805 (1005-2012)	10-1000							
	For High Speed Signal Lines	BLM_B	0402-0805 (1005-2012)	5-2700							
	Power Lines Type	BLM_PG*	0603-1806 (1608-4516)	22(6A)-1000(1.5A)							
For GHz Band Noise	Universal Type [Power Lines/Signal Lines]	BLM18EG*	0603 (1608)	100(2A)-600(0.5A)							
	Signal Lines Type	BLM_HG·HD	0402-0603 (1005-1608)	470-1800							

* The derating of rated current is required for some items according to the operating temperature.

Continued on the following page. 

NF□ Capacitor Type	Series	Size Code in inch (in mm)	Capacitance (F)	Effective Frequency Range (Applicable Frequency Ranges are only for reference.)						
Universal Type [Power Lines/Signal Lines]	NFM21HC	0805 (2012)	22p-1μ							
	NFM31HK*	1206 (3216)	10000p-0.1μ							

NF□ LC Combined Type	Series	Size Code in inch (in mm)	Capacitance (F)	Effective Frequency Range (Applicable Frequency Ranges are only for reference.)						
Universal Type [Power Lines/Signal Lines]	NFE61HT	2706 (6816)	33p-3300p							

DL□ Common Mode Choke Coils	Series	Size Code in inch (in mm)	Common Mode Impedance (Ω) at 100MHz	Effective Frequency Range (Applicable Frequency Ranges are only for reference.)						
Signal Lines Type	For Differential Signal Lines	DLW31S	2200							

DL□ Common Mode Choke Coils	Series	Size Code in inch (in mm)	Common Mode Inductance (μH) at 100MHz	Effective Frequency Range (Applicable Frequency Ranges are only for reference.)						
Signal Lines Type	For Differential Signal Lines	DLW43S	11-100							

PL□ Large Current Common Mode Choke Coils for Automotive Available	Series	Size Code in inch (in mm)	Common Mode Impedance (Ω) at 10MHz	Effective Frequency Range (Applicable Frequency Ranges are only for reference.)						
Power Lines Type	PLT10H*	-	45-1000							

BNX□ Block EMIFIL®	Series	Height (mm)	Rated Voltage (Vdc)	Rated Current (A)	Effective Frequency Range (Applicable Frequency Ranges are only for reference.)						
					10kHz	100kHz	1MHz	10MHz	100MHz	1GHz	10GHz
Power Lines Type	SMD Type	BNX024H01*	3.5	50	15						
		BNX025H01*	3.5	25	15						
		BNX026H01*	3.5	50	15						
		BNX027H01*	3.5	16	15						
	Lead Type	BNX012H01*	8.5 max.	50	15						

VF□ Lead Type Capacitors with Varistor Function	Series	Height (mm)	Capacitance (F)	Varistor Voltage (V)
Power Lines Type	VFC2	6.0 max.	1.0μ	27

Infotainment/Comfort

BL□ Inductor Type	Series	Size Code in inch (in mm)	Impedance (Ω) at 100MHz	Effective Frequency Range (Applicable Frequency Ranges are only for reference.)						
				10kHz	100kHz	1MHz	10MHz	100MHz	1GHz	10GHz
For General Band Noise	Universal Type [Power Lines/Signal Lines]	BLM_AX	0201-0402 (0603-1005)	10-1000						
	For General Signal Lines	BLM_AG	0201-0805 (0603-2012)	10-1000						
	For High Speed Signal Lines	BLM_B	0201-0805 (0603-2012)	5-2700						
	Power Lines Type	BLM_PX*·PG*·P*·KG*·SG*	0201-1806 (0603-4516)	10(1A)-1000(1.5A)						
		BLE32PN	1210 (3225)	30						

* The derating of rated current is required for some items according to the operating temperature.

Continued on the following page. 

BL Inductor Type		Series	Size Code in inch (in mm)	Impedance (Ω) at 100MHz	Effective Frequency Range (Applicable Frequency Ranges are only for reference.) 10kHz 100kHz 1MHz 10MHz 100MHz 1GHz 10GHz
For GHz Band Noise	Universal Type [Power Lines/Signal Lines]	BLM_EB*·EG*·HE*	0201-0603 (0603-1608)	25(0.6A)-1500(0.5A)	
	Signal Lines Type	BLM_HG·HD·HB·HG	0201-0603 (0603-1608)	120-1800	
For High-GHz Band Noise	Signal Lines Type	BLM_GG·GA	0402-0603 (1005-1608)	75-470	

NF LC Combined Type		Series	Size Code in inch (in mm)	Cut-off Frequency (MHz)	Effective Frequency Range (Applicable Frequency Ranges are only for reference.) 10kHz 100kHz 1MHz 10MHz 100MHz 1GHz 10GHz
Signal Lines Type		NFL18ZT	0603 (1608)	50-500	

NF LC Combined Type		Series	Size Code in inch (in mm)	Capacitance (F)	Effective Frequency Range (Applicable Frequency Ranges are only for reference.) 10kHz 100kHz 1MHz 10MHz 100MHz 1GHz 10GHz
Universal Type [Power Lines/Signal Lines]		NFE31ZT	1206 (3216)	22p-2200p	

NF Inductor Type		Series	Size Code in inch (in mm)	Impedance (Ω) at 1MHz	Effective Frequency Range (Applicable Frequency Ranges are only for reference.) 10kHz 100kHz 1MHz 10MHz 100MHz 1GHz 10GHz
Universal Type [Power Lines/Signal Lines]		NFZ32BW	1210 (3225)	3.3-880	

DL Common Mode Choke Coils		Series	Size Code in inch (in mm)	Common Mode Impedance (Ω) at 100MHz	Effective Frequency Range (Applicable Frequency Ranges are only for reference.) 100kHz 1MHz 10MHz 100MHz 1GHz 10GHz
Signal Lines Type	For Differential Signal Lines	DLM11S	0504 (1210)	45-90	
		DLW21S	0805 (2012)	67-490	
Universal Type [Power Lines/Signal Lines]		DLW5BS*	2020 (5050)	500-800	
		DLW5AT*/DLW5BT*	2014 /2020 (5036)/(5050)	45-1400	

DS 3-Terminal Capacitors Lead Type		Series	Height (mm)	Capacitance (F)	Effective Frequency Range (Applicable Frequency Ranges are only for reference.) 10kHz 100kHz 1MHz 10MHz 100MHz 1GHz 10GHz
Universal Type [Power Lines/Signal Lines]		DSS1	7.5 max.	22p-0.1μ	

* The derating of rated current is required for some items according to the operating temperature.

Ferrite Cores

Infotainment/Comfort

Type	Line-up	Frequency (MHz)
Coating Cores	Workable with all line-ups	Several 10 to Several 100
Thin Type Sandwich Cores	Length of Core 10, 15, 20, 22, 29mm	

Coated type with a 50μm thin film coating that prevents scattering.
Thin type sandwich core (split type) provides prevention effectiveness if cracking should occur.

Inductors



Application Matrix

Product Name	Series	Powertrain	Safety	Comfort	Infotainment
RF Inductors Film Type	LQP			●	●
RF Inductors Multilayer Type	LQG	●	●	●	●
RF Inductors/Power Lines Wire Wound Type	LQW			●	●
Power Lines/General Circuit Multilayer Type	LQM	●	●	●	●
Power Lines/General Circuit Wire Wound Type	LQH	●	●	●	●

Powertrain/Safety

Series	Type	Size Code in inch (in mm)	Thickness (mm/max.)	Inductance Range (H)							Rated Current	
				1n	10n	100n	1μ	10μ	100μ	1m		10m
LQG	RF Inductors Multilayer Type	0402 (1005)	—				1.0nH-270nH					110mA-300mA
		0603 (1608)	—				1.2nH-270nH					200mA-500mA
LQM	Power Lines/General Circuit Multilayer Type	0805 (2012)	1.2 ≥ Size T ≥ 1					2.2μH				800mA
LQH	Power Lines/General Circuit Wire Wound Type	1210 (3225)	Size T > 1.2					0.15μH-22μH				250mA-1.45A

Infotainment/Comfort

Series	Type	Size Code in inch (in mm)	Thickness (mm/max.)	Inductance Range (H)							Rated Current	
				1n	10n	100n	1μ	10μ	100μ	1m		10m
LQP	RF Inductors Film Type	0201 (0603)	—				0.6nH-120nH					80mA-850mA
LQG	RF Inductors Multilayer Type	0402 (1005)	—				1.0nH-270nH					110mA-300mA
LQW	RF Inductors/Power Lines Wire Wound Type	0402 (1005)	—				1.3nH-120nH					110mA-1.2A
		0603 (1608)	—				2.2nH-470nH					75mA-1.4A
LQM	Power Lines/General Circuit Multilayer Type	0805 (2012)	1 > Size T					0.47μH-2.2μH				600mA-1.1A
			1.2 ≥ Size T ≥ 1					0.47μH-4.7μH				800mA-1.3A
		0806 (2016)	1.2 ≥ Size T ≥ 1					0.47μH-4.7μH				1.1A-1.6A
		1008 (2520)	1 > Size T					0.56μH				1.5A
			1.2 ≥ Size T ≥ 1				0.24μH-4.7μH				800mA-1.8A	
LQH	Power Lines/General Circuit Wire Wound Type	1008 (2520)	1.2 ≥ Size T ≥ 1					0.47μH-22μH				430mA-2.75A
		1206 (3216)	Size T > 1.2					0.054μH-0.88μH				180mA-920mA
		1210 (3225)	Size T > 1.2					0.47μH-330μH				60mA-2.9A
		1212 (3030)	1.2 ≥ Size T ≥ 1					0.47μH-47μH				460mA-2.86A
		1515 (4040)	1.2 ≥ Size T ≥ 1					0.68μH-47μH				410mA-2.5A
		1812 (4532)	Size T > 1.2					1.0μH-2200μH				30mA-3.3A
		2020 (5050)	Size T > 1.2					0.47μH-22μH				1.05A-4.0A

Thermistors

Application Matrix

Product Name		Series	Powertrain	Safety	Comfort	Infotainment
PTC Thermistors (POSISTOR®)	Chip Type	PRF	●	●	●	●
		PRG	●	●	●	●
	Lead Type	PTGL	●	●	●	●

PTC Thermistors (POSISTOR®) Chip Type

Optimal for overheat detection at heat generation areas including power transistors, power diodes and power ICs.

Series	Sensing Temperature (°C)	Max. Voltage (V)	Operating Temperature Range (°C)
PRF	+65 to +145*	32	-40 to +150

* The line-up contains nine models in 10°C increments. Detection precision: ±5°C (±3°C models are also available).

Optimal for over-current protection for various circuits including those for car navigation.

Series	Sensing Temperature (°C)	Max. Voltage (V)	Operating Temperature Range (°C)
PRG	±20	16 to 20	-40 to +105

PTC Thermistors (POSISTOR®) Lead Type

Optimal for over-current protection for various circuits including those for car navigation.

Series	Resistance Tolerance (%)	Operating Temperature Range (°C)	Max. Voltage (V)
PTGL□S	±10	-40 to +125	16 to 140
	±20	-30 to +85	

Timing Devices

Application Matrix

Product Name		Series	Powertrain	Safety	Comfort	Infotainment
Crystal Units		XRC	●	●	●	●
Ceramic Resonators CERALOCK®		CSTCR/CSTCE	●	●	●	●

Crystal Units

Murata offers a wide lineup of small Crystal Units based on the original excellent package technology and high grade quartz crystal elements. Suitable for Powertrain, ADAS, Chassis and Safety applications, etc.

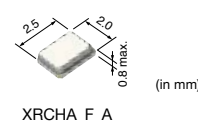

Series	Frequency Range (MHz)											Frequency Shift by Temperature (ppm)	Operating Temperature Range (°C)					
	1	2	3	4	5	6	7	8	9	10	20			30	40	50	70	100
XRCHA_F_A											16.0000±0.1%-24.0000±0.1%						±100	-40 to +125

Continued on the following page.

Ceramic Resonators CERALOCK® (Tight Frequency Tolerance)

An ideal tight frequency tolerance is achieved for CAN-BUS. This product can be mounted with Pb free soldering (Sn-Ag-Cu).



Series	Frequency Range (MHz)											Temperature Stability (%)	Operating Temperature Range (°C)						
	1	2	3	4	5	6	7	8	9	10	20			30	40	50	70	100	
CSTCR_G15C											4.00±0.1%-7.99±0.1%							±0.13	-40 to +125
CSTCE_G15C											8.00±0.1%-13.99±0.1%								
CSTCE_V13C											14.00±0.1%-24.00±0.1%								

Ceramic Resonators CERALOCK® (Standard Frequency Tolerance)

This product can be mounted with Pb free soldering (Sn-Ag-Cu).

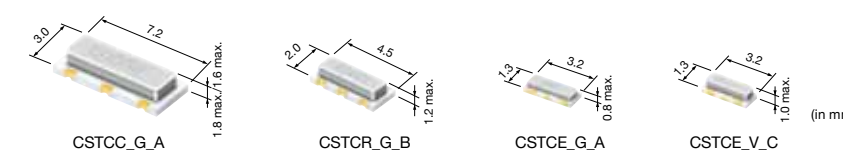

Series	Frequency Range (MHz)											Temperature Stability (%)	Operating Temperature Range (°C)						
	1	2	3	4	5	6	7	8	9	10	20			30	40	50	70	100	
CSTCC_G_A											2.00±0.5%-3.99±0.5%							±0.4 (15pF) -0.6/+0.3 (47pF)	-40 to +125
CSTCR_G_B											4.00±0.5%-7.99±0.5%								
CSTCE_G_A											8.00±0.5%-13.99±0.5%								
CSTCE_V_C											14.00±0.5%-24.00±0.5%								

Ceramic Substrates

Powertrain Safety Infotainment

Low Temperature Co-fired Ceramic Functional Substrates

LFC® substrates provide high reliability under harsh conditions such as high temperatures and strong vibration.

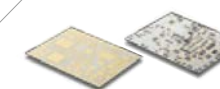

Application examples that utilize LFC® Substrates: ABS, TCU, EPS *Other RF Modules

Characteristics	Ceramic Composition	Bulk Density (g)	Flexural Strength (MPa)	Thermal Expansion Co-efficient	Dielectric Constant
	CaO-Al ₂ O ₃ -SiO ₂ -B ₂ O ₃ +Al ₂ O ₃	2.9/cm ³	270 min.	5.5×10 ⁻⁶ /°C	7.7 (1MHz)
	Temperature Coefficient (TCC)	Dielectric Loss	Thermal Conductivity (W)	Insulation Resistance between Layers (Ω)	Breakdown Voltage (kV)
110ppm/°C max.	6×10 ⁻⁴ (1MHz)/5×10 ⁻³ (10GHz)	2.5/m·K	10 ¹⁰ min.	5 (300μm) min.	

Products for Radio Communication Safety Comfort Infotainment

CERAFIL® 10.7MHz Chip Type

Compact and lightweight filter for IF circuits adapting the piezoelectric function of ceramic.

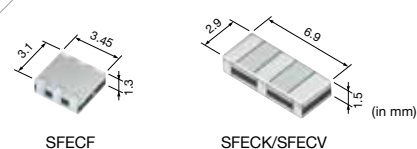

Series	Type	3dB Bandwidth (kHz)						
		D	E	F	G	H	J	K
		350	330	280	230	180	150	110
SFECF10M7□	Standard Type	●	●	●	●	●	—	—
SFECK10M7□	High-reliability Type	—	—	—	—	—	●	●
SFECV10M7□	Standard Type	—	—	—	—	—	●	●
SFECV15M0□	Standard Type	—	●	—	—	—	—	—

□ is filled in with a letter denoting 3dB bandwidth.

Ceramic Discriminators

In combination with ICs, this type obtains stable demodulation characteristics in a wide bandwidth.

Series	Center Frequency
CDCSB	10.700MHz±30kHz

Recommended part number depends on IC specifications. Please contact us with the IC part number to be applied.

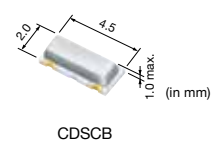

Sensors Comfort Infotainment

Rotary Position Sensors

Angle detection: feedback sensor for motor actuators, etc. Position detection: replaces limit switches
Switching: replaces rotary switches Variable resistance: works as a low-profile, long-life variable resistor

Series	Total Resistance (kΩ)	Linearity (%)	Effective Electric Rotational Angle (°)	Operating Temperature Range (°C)	Rotational Life (Cycle)
SV01 Series	10	2	333.3	-40 to +85	1M
SV03 Series	10	2	333.3	-40 to +125	300k



Care and the Future

Sound Components Comfort Infotainment

Piezoelectric Sounders

Sound components to generate acknowledgment tone in instrumental panel, power slide door alarm, ultrasonic sonar operation alert and other alarm sounds.

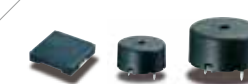

Series	Type	Features
PKLCS	SMD Type	Super-compact and low-profiled, workable with automatic mounting and reflow soldering
PKM_EPP(H)	Pin Type	General-purpose products, low frequency (2kHz) products and high sound pressure products are in the line-up
PKM13EPYH	Pin Type	Small and low-profiled, workable with automatic insertion

Products for Power Supply Comfort

Ionizer Modules Ionissimo® (High-concentration ion, compact design, ozone control)

Ionissimo® is an ionizer module with unprecedented compactness and high efficiency, capable of generating the largest amount of ions in the industry owing to Murata's own high-voltage technology and structural design. The ion generator is connected to the driving power supply for modularization and ease of incorporating into equipment.

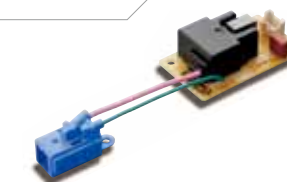

MHM Series

- A large amount of ion will be created by original structure.
- Compact equipment may be designed due to small ionizer element and driving power supply.
- Ozone amounts may be optimized for specific applications by controlling the generation of ozone without changing the number of ions.

For Automotive/Variety Product Catalogs <http://www.murata.com/en-global/support/library/catalog/>



Chip Monolithic Ceramic Capacitors for Automotive

Cat.No.C03E



Radial Lead Type Monolithic Ceramic Capacitors

Cat.No.C49E



EMI Suppression Filters (for DC)/ Chip Inductors for Automotive

Cat.No.C51E



Ceramic Resonators (CERALOCK®)

Cat.No.P16E



Low Temperature Co-fired Ceramics (LTCC) Multi-layer Module Boards

Cat.No.N20E

Corporate Activities

Value for Market

Providing a network to link the world, and solutions without borders.

Murata's electronic components are used throughout the world in fields ranging from home intelligent appliances to industrial electronics and car electronics. The production and supply of these components is supported by a global network consisting of production and sales offices in over a dozen countries. By this worldwide network, Murata is actively involved in a borderless and far-reaching effort to turn even more ideas into reality.

Murata's globally accepted electronic components

For all of its leading products, Murata maintains a market share that is one of the highest in the world. Murata's electronic components play an important role inside many types of devices around the world.

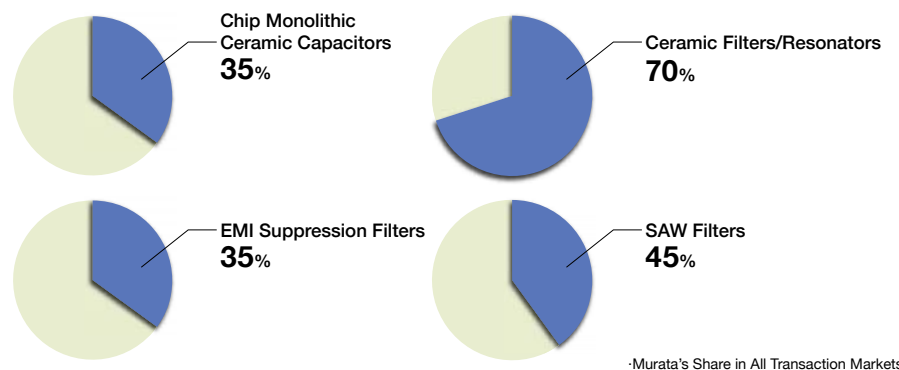

Quality Management System

Continuous Improvement of the Quality Management System.

Murata continuously improves the effectiveness and efficiency of the quality management system, with all functions at all levels improving continuously in synch with each other. All personnel ensure that the quality of their work improves in an upward spiral, and in this way we provide quality that satisfies our customers.

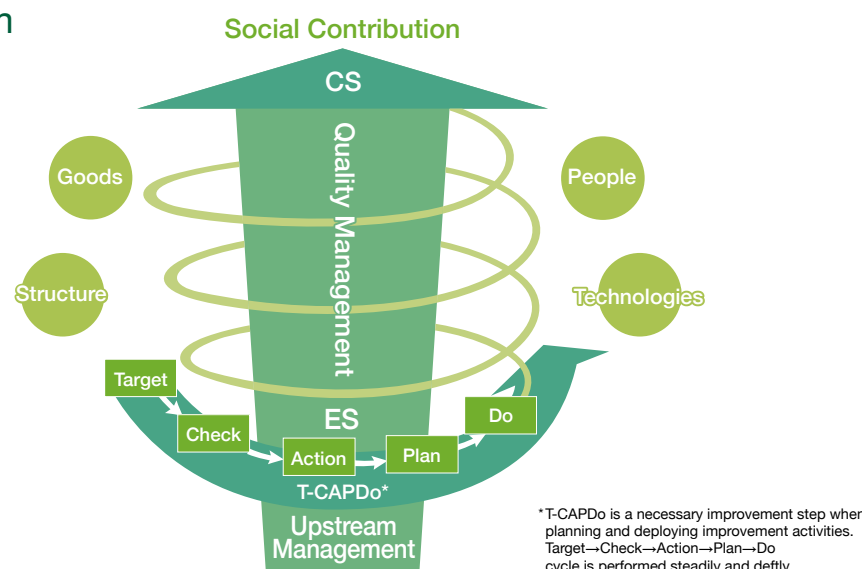

ISO9001 and ISO/TS16949

For a company with global business operations, it is important to meet a single global standard of product quality.

All Murata Group plants inside and outside Japan have received certification under the international quality management standard ISO9001. Of these plants, 14 supplying the automotive industry have also been certified as meeting the ISO/TS16949 quality management standard, a stricter international standard specific to the automotive industry.

Certified According to International Quality Management Standards

Plants/Subsidiaries	Registration Standard	Plants/Subsidiaries	Registration Standard
Murata Manufacturing Co., Ltd., Yokaiichi Plant	ISO9001 ISO/TS16949	Wakura Murata Manufacturing Co., Ltd.	ISO9001
Murata Manufacturing Co., Ltd., Yasu Plant	ISO9001	Asuwa Murata Manufacturing Co., Ltd.	ISO9001
Fukui Murata Manufacturing Co., Ltd.	ISO9001 ISO/TS16949	Anamizu Murata Manufacturing Co., Ltd.	ISO9001
Toyama Murata Manufacturing Co., Ltd.	ISO9001 ISO/TS16949	Tokyo Denpa Co., Ltd.	ISO9001
Kanazawa Murata Manufacturing Co., Ltd.	ISO9001	Murata Electronics (Thailand), Ltd.	ISO9001 ISO/TS16949
Himi Murata Manufacturing Co., Ltd.	ISO9001 ISO/TS16949	Murata Electronics Singapore (Pte.) Ltd.	ISO9001 ISO/TS16949
Hakui Murata Manufacturing Co., Ltd.	ISO9001 ISO/TS16949	Wuxi Murata Electronics Co., Ltd.	ISO9001 ISO/TS16949
Sabae Murata Manufacturing Co., Ltd.	ISO9001	Shenzhen Murata Technology Co.,Ltd.	ISO9001
Ogaki Murata Manufacturing Co., Ltd.	ISO9001 ISO/TS16949	Taiwan Murata Electronics Co., Ltd.	ISO9001
Izumo Murata Manufacturing Co., Ltd.	ISO9001 ISO/TS16949	Murata Electronics (Malaysia) Sdn. Bhd.	ISO9001
Iwami Murata Manufacturing Co., Ltd.	ISO9001 ISO/TS16949	Murata Electronics Europe B.V.	ISO9001
Okayama Murata Manufacturing Co., Ltd.	ISO9001	Murata Electronics North America Inc.	ISO9001
Azumi Murata Manufacturing Co., Ltd.	ISO9001 ISO/TS16949	Murata Electronics Oy	ISO9001 ISO/TS16949
Tome Murata Manufacturing Co., Ltd.	ISO9001 ISO/TS16949	Philippine Manufacturing Company of Murata INC.	ISO9001
Komoro Murata Manufacturing Co., Ltd.	ISO9001	Murata Power Solutions Inc.	ISO9001
Komatsu Murata Manufacturing Co., Ltd.	ISO9001		
Kanazu Murata Manufacturing Co., Ltd.	ISO9001		

For further details, please visit the following website:
<http://www.murata.com/corporate/csr/social/customer/status.html>

Environment

Continuing Our Quest for Harmony with the Environment

- In All Our Corporate Activities, Including Development, Design and Production -

We assess the impact of our products on the environment from the development and design stages, to ensure that every product we offer our customers takes the environment into consideration. We classify products that go even further towards contributing to reduced environmental impact as "Eco-friendly Products" and we are working to create a wider range of these products.

Eco-products

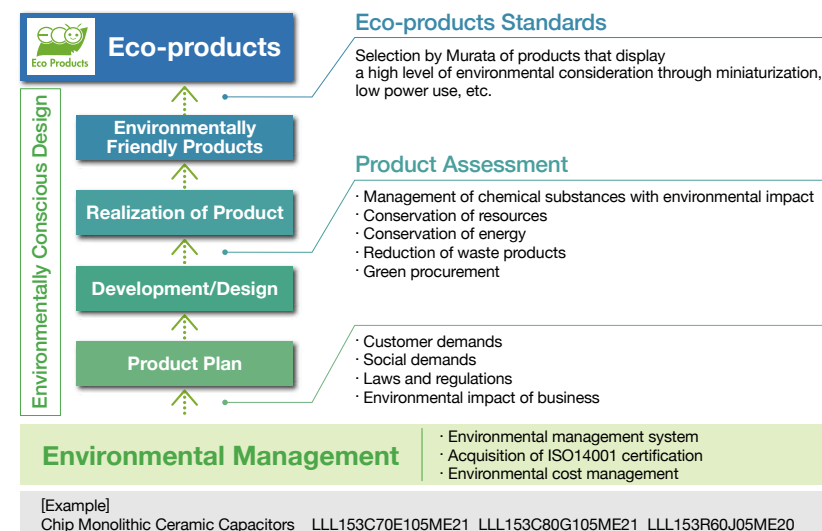

Global Multi-site

ISO14001 Certification

Murata had acquired ISO14001 certification for all its production plants in Japan and overseas, and all non-manufacturing sites in Japan (Murata Head Office, Tokyo branch and sales offices) by the end of fiscal 2006. We had concentrated on integrating systems, and in March 2007, we completed switching individual certification of the 34 domestic Group business sites to ISO14001 multi-site certification. Since then, we have implemented an integrated environmental management system from design and development to production and sales, and also applied improvements that proved successful in one plant or office to other plants or offices, so as to improve the environmental performance of the entire Murata Group.

In March 2010, we integrated the environmental management systems of all our domestic business sites and overseas production plants. By building a global environmental management system, we have further enhanced our governance as a Group, and enabled the implementation of more efficient and highly effective environmental activities.

In addition, while we previously conducted the PDCA cycle on an individual business site basis, since 2012 we have been conducting the cycle on the basis of management units consisting of multiple business sites. In fiscal 2013, we included Komoro Murata Manufacturing Co., Ltd., and PHILIPPINE MANUFACTURING CO. OF MURATA, INC., in the scope of our multi-site certification. As a result, the scope of the certification now includes all of our domestic business sites as well as our sites in China and the Philippines.

ISO 14001 Certification Status: <http://www.murata.com/en-eu/about/csr/certification/iso14001>

Management of Substances with Environmental Impact

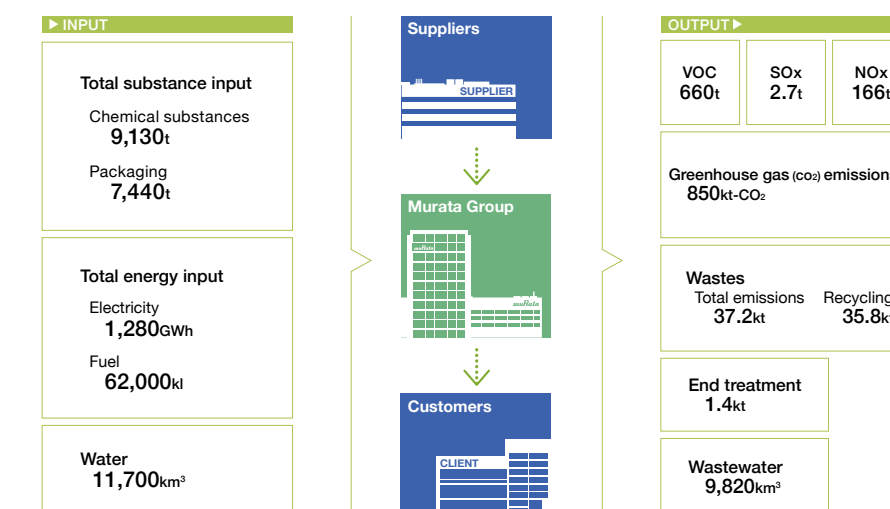

* Beginning this fiscal year, GHG Protocol (2005) coefficients for each country are used for CO₂ emissions from electricity purchased at overseas plants.

The shown data in this chart is the data gained from April, 2013 in March, 2014.

Global Locations

For details please visit www.murata.com



⚠ Note

1 Export Control

For customers outside Japan:

No Murata products should be used or sold, through any channels, for use in the design, development, production, utilization, maintenance or operation of, or otherwise contribution to (1) any weapons (Weapons of Mass Destruction [nuclear, chemical or biological weapons or missiles] or conventional weapons) or (2) goods or systems specially designed or intended for military end-use or utilization by military end-users.

For customers in Japan:

For products which are controlled items subject to the "Foreign Exchange and Foreign Trade Law" of Japan, the export license specified by the law is required for export.

2 Please contact our sales representatives or product engineers before using the products in this catalog for the applications listed below, which require especially high reliability for the prevention of defects which might directly damage a third party's life, body or property, or when one of our products is intended for use in applications other than those specified in this catalog.

- ① Aircraft equipment
- ② Aerospace equipment
- ③ Undersea equipment
- ④ Power plant equipment
- ⑤ Medical equipment
- ⑥ Transportation equipment (vehicles, trains, ships, etc.)
- ⑦ Traffic signal equipment
- ⑧ Disaster prevention / crime prevention equipment
- ⑨ Data-processing equipment
- ⑩ Application of similar complexity and/or reliability requirements to the applications listed above

3 Product specifications in this catalog are as of September 2014. They are subject to change or our products in it may be discontinued without advance notice. Please check with our sales representatives or product engineers before ordering. If there are any questions, please contact our sales representatives or product engineers.

4 Please read rating and ⚠CAUTION (for storage, operating, rating, soldering, mounting and handling) in this catalog to prevent smoking and/or burning, etc.

5 This catalog has only typical specifications. Therefore, please approve our product specifications or transact the approval sheet for product specifications before ordering.

6 Please note that unless otherwise specified, we shall assume no responsibility whatsoever for any conflict or dispute that may occur in connection with the effect of our and/or a third party's intellectual property rights and other related rights in consideration of your use of our products and/or information described or contained in our catalogs. In this connection, no representation shall be made to the effect that any third parties are authorized to use the rights mentioned above under licenses without our consent.

7 No ozone depleting substances (ODS) under the Montreal Protocol are used in our manufacturing process.

Murata Manufacturing Co., Ltd.

www.murata.com

muRata
INNOVATOR IN ELECTRONICS