

Triacs

BT137B series

GENERAL DESCRIPTION

Passivated triacs in a plastic envelope suitable for surface mounting, intended for use in applications requiring high bidirectional transient and blocking voltage capability and high thermal cycling performance. Typical applications include motor control, industrial and domestic lighting, heating and static switching.

QUICK REFERENCE DATA

SYMBOL	PARAMETER	MAX.	MAX.	UNIT
V_{DRM}	Repetitive peak off-state voltages	600	800	V
$I_{T(RMS)}$	RMS on-state current	8	8	A
I_{TSM}	Non-repetitive peak on-state current	65	65	A

PINNING - SOT404

PIN	DESCRIPTION
1	main terminal 1
2	main terminal 2
3	gate
mb	main terminal 2

PIN CONFIGURATION

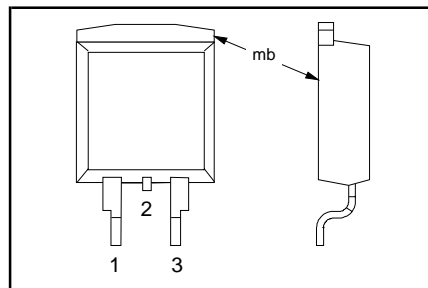

SYMBOL

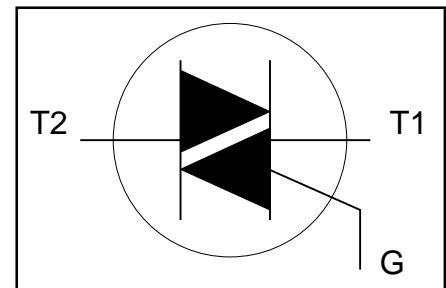

LIMITING VALUES

Limiting values in accordance with the Absolute Maximum System (IEC 134).

SYMBOL	PARAMETER	CONDITIONS	MIN.	MAX.		UNIT
				-600 600 ¹	-800 800	
V_{DRM}	Repetitive peak off-state voltages		-	-600 600 ¹	-800 800	V
$I_{T(RMS)}$	RMS on-state current	full sine wave; $T_{mb} \leq 102\text{ }^\circ\text{C}$	-	8		A
I_{TSM}	Non-repetitive peak on-state current	full sine wave; $T_j = 25\text{ }^\circ\text{C}$ prior to surge $t = 20\text{ ms}$	-	65		A
		$t = 16.7\text{ ms}$	-	71		A
I^2t	I^2t for fusing	$t = 10\text{ ms}$	-	21		A ² s
di_t/dt	Repetitive rate of rise of on-state current after triggering	$I_{TM} = 12\text{ A}$; $I_G = 0.2\text{ A}$; $di_G/dt = 0.2\text{ A}/\mu\text{s}$	-	50		A/ μs
		T2+ G+	-	50		A/ μs
		T2+ G-	-	50		A/ μs
		T2- G-	-	10		A/ μs
		T2- G+	-	2		A
I_{GM}	Peak gate current		-	5		V
V_{GM}	Peak gate voltage		-	5		W
P_{GM}	Peak gate power		-	0.5		W
$P_{G(AV)}$	Average gate power	over any 20 ms period	-	150		$^\circ\text{C}$
T_{stg}	Storage temperature		-40	125		$^\circ\text{C}$
T_j	Operating junction temperature		-	125		$^\circ\text{C}$

¹ Although not recommended, off-state voltages up to 800V may be applied without damage, but the triac may switch to the on-state. The rate of rise of current should not exceed 6 A/ μs .

Triacs

BT137B series

THERMAL RESISTANCES

SYMBOL	PARAMETER	CONDITIONS	MIN.	TYP.	MAX.	UNIT
$R_{th\ j-mb}$	Thermal resistance junction to mounting base	full cycle	-	-	2.0	K/W
		half cycle	-	-	2.4	K/W
$R_{th\ j-a}$	Thermal resistance junction to ambient	minimum footprint, FR4 board	-	55	-	K/W

STATIC CHARACTERISTICS

 $T_j = 25\text{ }^\circ\text{C}$ unless otherwise stated

SYMBOL	PARAMETER	CONDITIONS	MIN.	TYP.	MAX.			UNIT
I_{GT}	Gate trigger current	BT137B- $V_D = 12\text{ V}; I_T = 0.1\text{ A}$	-	-F	...G	
		T2+ G+	-	5	35	25	50	mA
		T2+ G-	-	8	35	25	50	mA
		T2- G-	-	11	35	25	50	mA
		T2- G+	-	30	70	70	100	mA
I_L	Latching current	$V_D = 12\text{ V}; I_{GT} = 0.1\text{ A}$	-	-	-	-	-	
		T2+ G+	-	7	30	30	45	mA
		T2+ G-	-	16	45	45	60	mA
		T2- G-	-	5	30	30	45	mA
		T2- G+	-	7	45	45	60	mA
I_H	Holding current	$V_D = 12\text{ V}; I_{GT} = 0.1\text{ A}$	-	5	20	20	40	mA
V_T	On-state voltage	$I_T = 10\text{ A}$	-	1.3	1.65			V
V_{GT}	Gate trigger voltage	$V_D = 12\text{ V}; I_T = 0.1\text{ A}$	-	0.7	1.5			V
		$V_D = 400\text{ V}; I_T = 0.1\text{ A};$ $T_j = 125\text{ }^\circ\text{C}$	0.25	0.4	-			V
I_D	Off-state leakage current	$V_D = V_{DRM(max)};$ $T_j = 125\text{ }^\circ\text{C}$	-	0.1	0.5			mA

DYNAMIC CHARACTERISTICS

 $T_j = 25\text{ }^\circ\text{C}$ unless otherwise stated

SYMBOL	PARAMETER	CONDITIONS	MIN.			TYP.	MAX.	UNIT
dV_D/dt	Critical rate of rise of off-state voltage	BT137B- $V_{DM} = 67\% V_{DRM(max)};$ $T_j = 125\text{ }^\circ\text{C};$ exponential waveform; gate open circuitF	...G	250	-	V/ μs
dV_{com}/dt	Critical rate of change of commutating voltage	$V_{DM} = 400\text{ V}; T_j = 95\text{ }^\circ\text{C};$ $I_{T(RMS)} = 8\text{ A};$ $dl_{com}/dt = 3.6\text{ A/ms};$ gate open circuit	-	-	10	20	-	V/ μs
t_{gt}	Gate controlled turn-on time	$I_{TM} = 12\text{ A}; V_D = V_{DRM(max)};$ $I_G = 0.1\text{ A}; dl_G/dt = 5\text{ A}/\mu\text{s}$	-	-	-	2	-	μs

Triacs

BT137B series

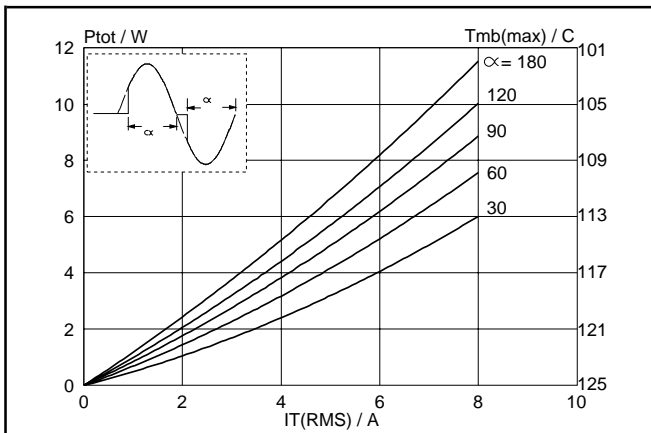

Fig.1. Maximum on-state dissipation, P_{tot} , versus rms on-state current, $I_{T(RMS)}$, where $\alpha =$ conduction angle.

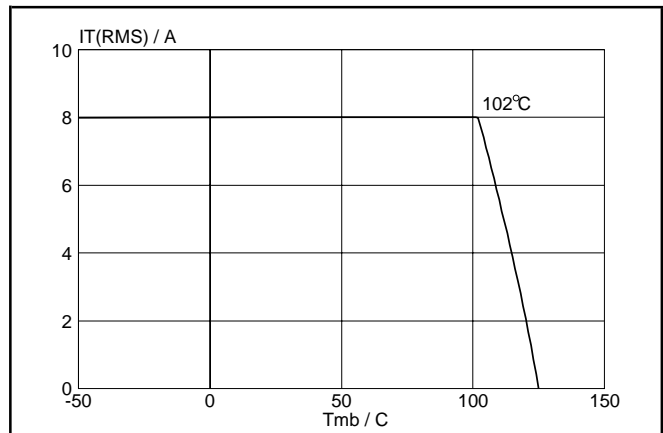

Fig.4. Maximum permissible rms current $I_{T(RMS)}$, versus mounting base temperature T_{mb} .

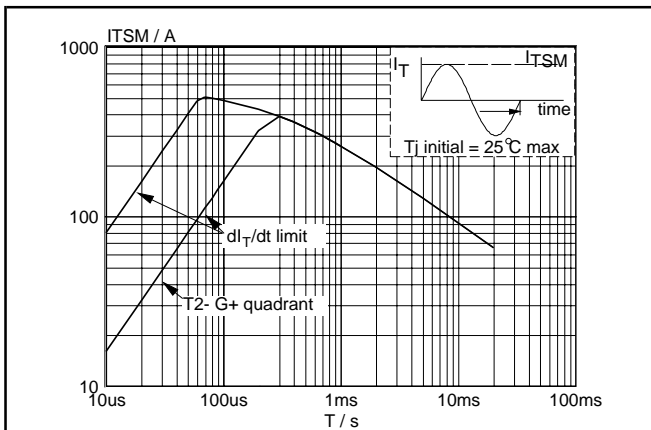

Fig.2. Maximum permissible non-repetitive peak on-state current I_{TSM} , versus pulse width t_p , for sinusoidal currents, $t_p \leq 20ms$.

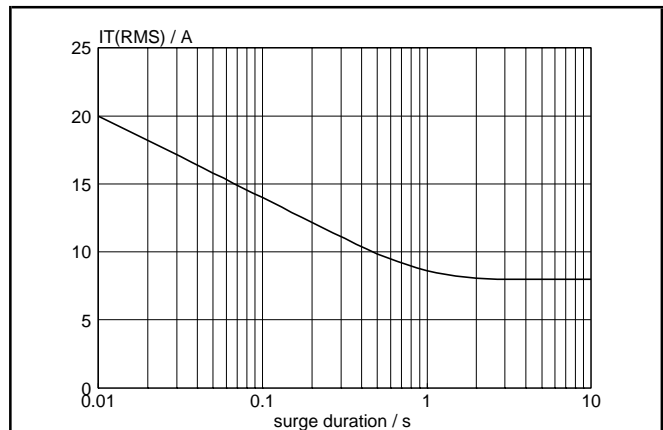

Fig.5. Maximum permissible repetitive rms on-state current $I_{T(RMS)}$, versus surge duration, for sinusoidal currents, $f = 50$ Hz; $T_{mb} \leq 102^\circ\text{C}$.

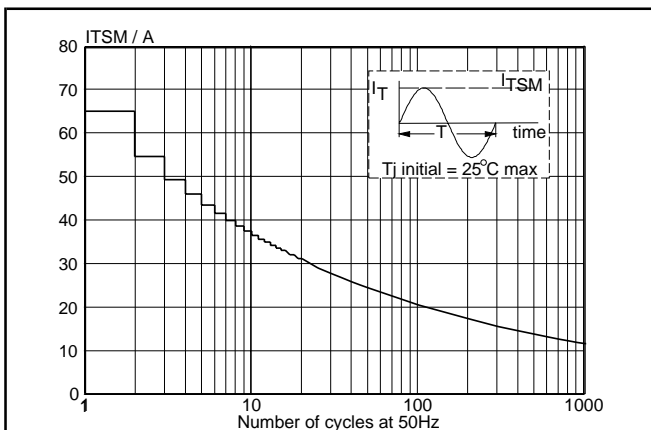

Fig.3. Maximum permissible non-repetitive peak on-state current I_{TSM} , versus number of cycles, for sinusoidal currents, $f = 50$ Hz.

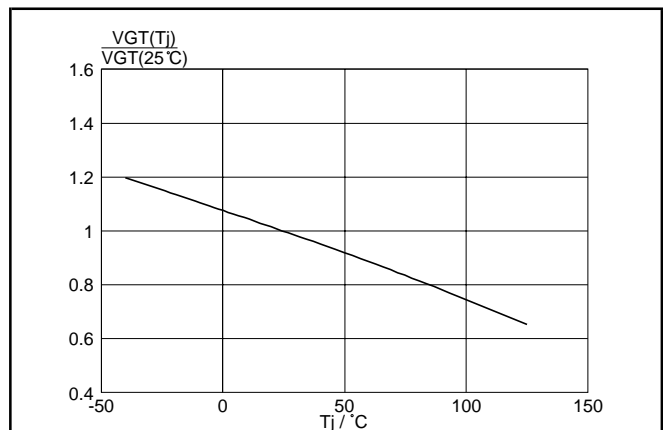
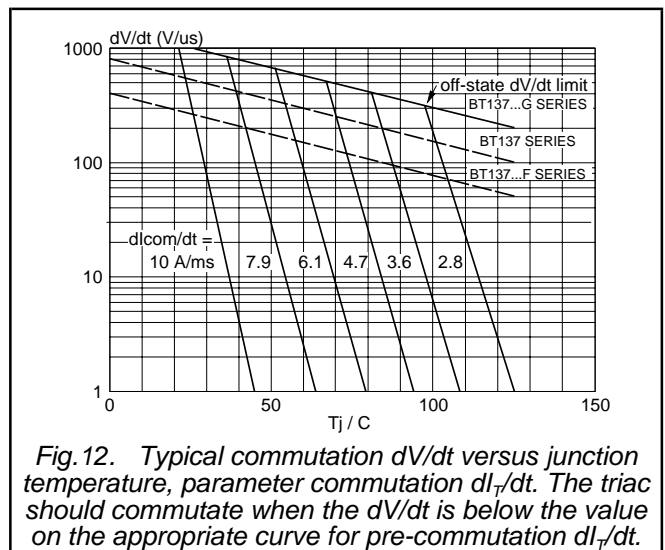
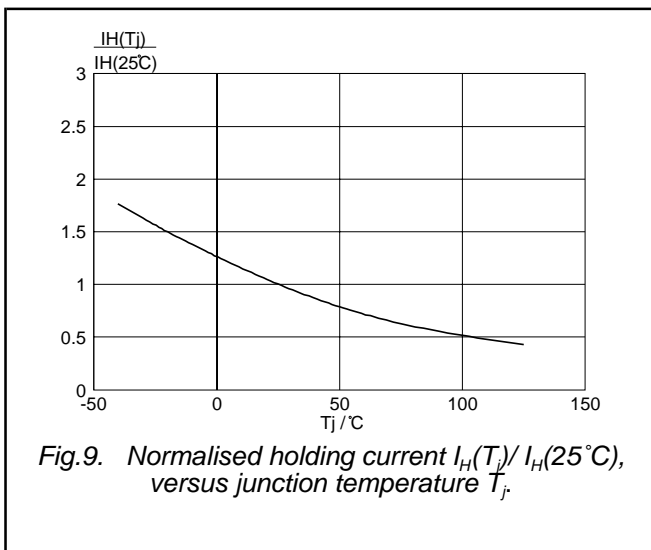
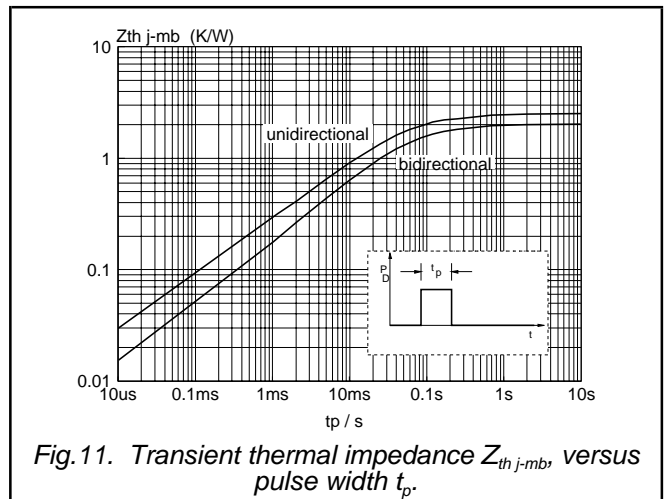
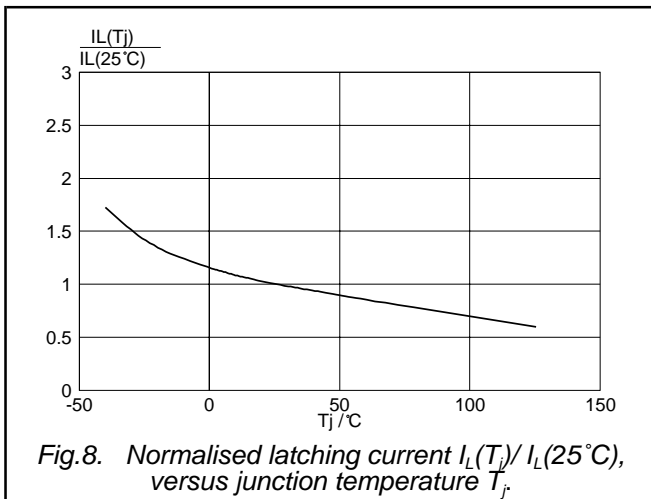
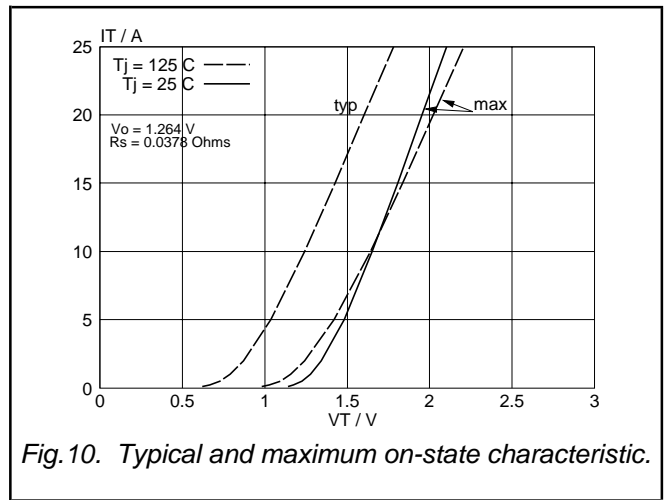
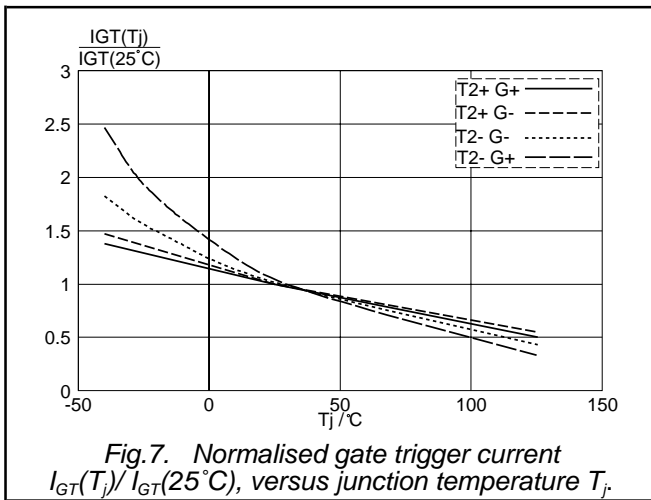

Fig.6. Normalised gate trigger voltage $V_{GT}(T_j) / V_{GT}(25^\circ\text{C})$, versus junction temperature T_j .

Triacs

BT137B series



Triacs

BT137B series

MECHANICAL DATA

Dimensions in mm

Net Mass: 1.4 g

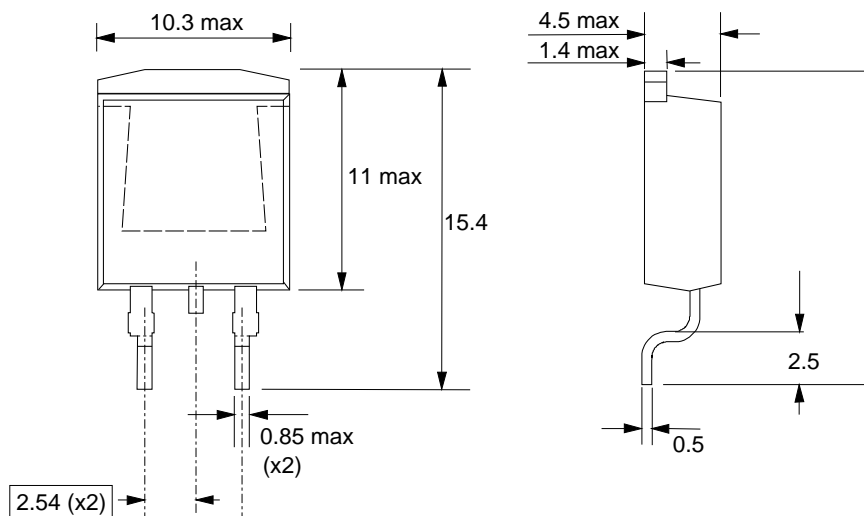

Fig.13. SOT404 : centre pin connected to mounting base.

MOUNTING INSTRUCTIONS

Dimensions in mm

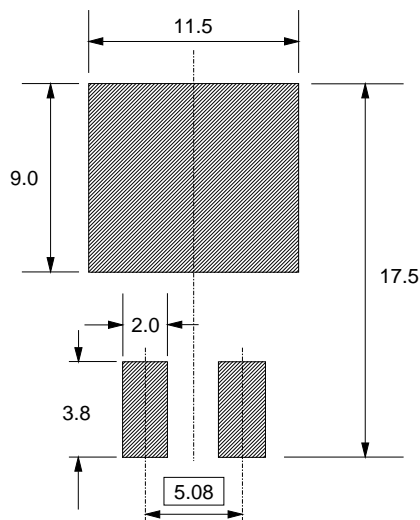

Fig.14. SOT404 : minimum pad sizes for surface mounting.

Notes

- 1. Plastic meets UL94 V0 at 1/8".

Triacs

BT137B series

DEFINITIONS

DATA SHEET STATUS		
DATA SHEET STATUS²	PRODUCT STATUS³	DEFINITIONS
Objective data	Development	This data sheet contains data from the objective specification for product development. Philips Semiconductors reserves the right to change the specification in any manner without notice
Preliminary data	Qualification	This data sheet contains data from the preliminary specification. Supplementary data will be published at a later date. Philips Semiconductors reserves the right to change the specification without notice, in order to improve the design and supply the best possible product
Product data	Production	This data sheet contains data from the product specification. Philips Semiconductors reserves the right to make changes at any time in order to improve the design, manufacturing and supply. Changes will be communicated according to the Customer Product/Process Change Notification (CPCN) procedure SNW-SQ-650A
Limiting values		
Limiting values are given in accordance with the Absolute Maximum Rating System (IEC 134). Stress above one or more of the limiting values may cause permanent damage to the device. These are stress ratings only and operation of the device at these or at any other conditions above those given in the Characteristics sections of this specification is not implied. Exposure to limiting values for extended periods may affect device reliability.		
Application information		
Where application information is given, it is advisory and does not form part of the specification.		
© Philips Electronics N.V. 2001		
All rights are reserved. Reproduction in whole or in part is prohibited without the prior written consent of the copyright owner.		
The information presented in this document does not form part of any quotation or contract, it is believed to be accurate and reliable and may be changed without notice. No liability will be accepted by the publisher for any consequence of its use. Publication thereof does not convey nor imply any license under patent or other industrial or intellectual property rights.		

LIFE SUPPORT APPLICATIONS

These products are not designed for use in life support appliances, devices or systems where malfunction of these products can be reasonably expected to result in personal injury. Philips customers using or selling these products for use in such applications do so at their own risk and agree to fully indemnify Philips for any damages resulting from such improper use or sale.

² Please consult the most recently issued datasheet before initiating or completing a design.

³ The product status of the device(s) described in this datasheet may have changed since this datasheet was published. The latest information is available on the Internet at URL <http://www.semiconductors.philips.com>.