

**SOT-89 Plastic-Encapsulate Voltage Regulators**
**79L05** Three-terminal positive voltage regulator

**SOT-89-3L**
**FEATURES**

- Maximum output current  
 $I_{OM}$ : 0.1A
- Output voltage  
 $V_O$ : -5V
- Continuous total dissipation  
 $P_D$ : 0.6 W ( $T_a=25^\circ\text{C}$ )

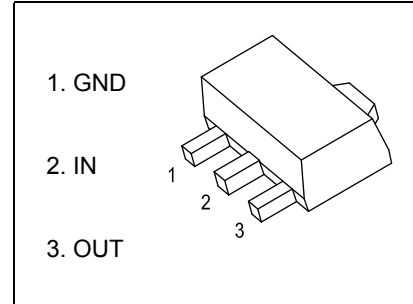

**ABSOLUTE MAXIMUM RATINGS (Operating temperature range applies unless otherwise specified)**

Parameter	Symbol	Value	Unit
Input Voltage	$V_i$	-35	V
Thermal Resistance from Junction to Ambient	$R_{\theta JA}$	208.3	$^\circ\text{C/W}$
Operating Junction Temperature Range	$T_{OPR}$	0~+150	$^\circ\text{C}$
Storage Temperature Range	$T_{STG}$	-65~+150	$^\circ\text{C}$

**ELECTRICAL CHARACTERISTICS AT SPECIFIED VIRTUAL JUNCTION TEMPERATURE ( $V_i=-10\text{V}, I_o=40\text{mA}, C_i=0.33\mu\text{F}, C_o=0.1\mu\text{F}$ , unless otherwise specified)**

Parameter	mbol	Test conditions	Mj	Tnd	'Max	Unit	
Output Voltage	$V_o$	$25^\circ\text{C}$	-4.80	-5.0	-5.2	V	
		0-125 $^\circ\text{C}$	$-7\text{V} \leq V_i \leq -20\text{V}, I_o=1\text{mA} \sim 40\text{mA}$	-4.75	-5.0	-5.25	V
			$I_o=1\text{mA} \sim 70\text{mA}$	-4.75	-5.0	-5.25	V
Load Regulation	$\Delta V_o$	$I_o=1\text{mA} \sim 100\text{mA}$	$25^\circ\text{C}$		20	60	mV
		$I_o=1\text{mA} \sim 40\text{mA}$	$25^\circ\text{C}$		10	30	mV
Line Regulation	$\Delta V_o$	$-7\text{V} \leq V_i \leq -20\text{V}$	$25^\circ\text{C}$		15	150	mV
		$-8\text{V} \leq V_i \leq -20\text{V}$	$25^\circ\text{C}$		12	100	mV
Quiescent Current	$I_q$		$25^\circ\text{C}$			6	mA
Quiescent Current Change	$\Delta I_q$	$-8\text{V} \leq V_i \leq -20\text{V}$	0-125 $^\circ\text{C}$			1.5	mA
		$1\text{mA} \leq I_o \leq 40\text{mA}$	0-125 $^\circ\text{C}$			0.1	mA
Output Noise Voltage	$V_N$	10Hz $\leq f \leq$ 100KHz	$25^\circ\text{C}$		40		$\mu\text{V}/V_o$
Ripple Rejection	RR	$-8\text{V} \leq V_i \leq -18\text{V}, f=120\text{Hz}$	0-125 $^\circ\text{C}$	41	49		dB
Dropout Voltage	$V_d$		$25^\circ\text{C}$		1.7		V

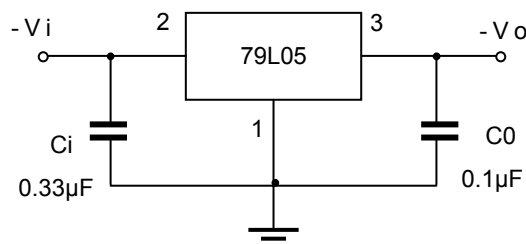
\* Pulse test.

**TYPICAL APPLICATION**

Note: Bypass capacitors are recommended for optimum stability and transient response and should be located as close as possible to the regulators.



Typical Characteristics

Output Characteristics

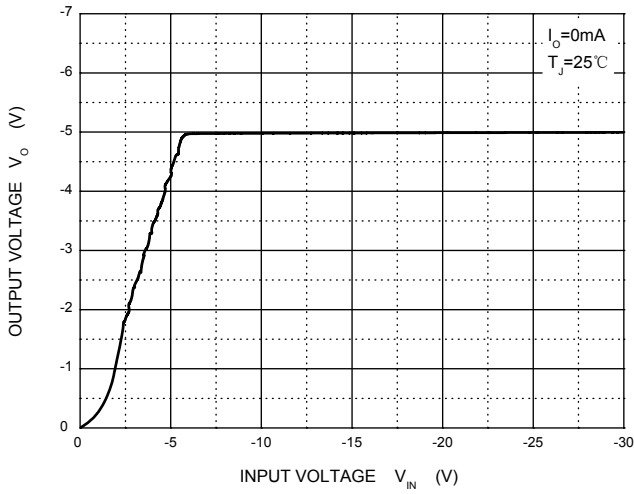

Dropout Characteristics

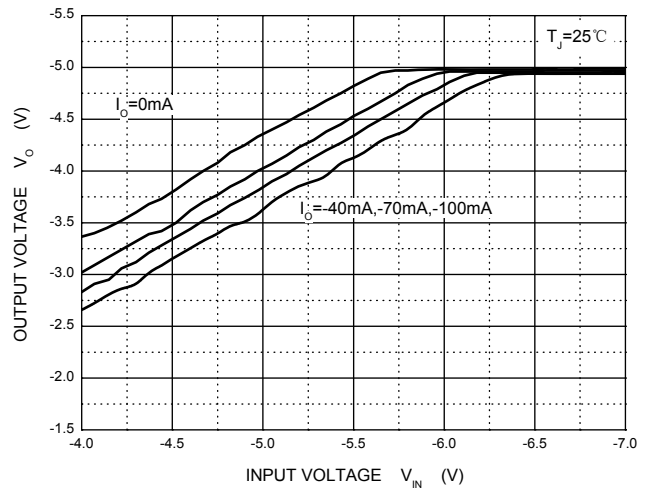

Quiescent Current vs Input Voltage

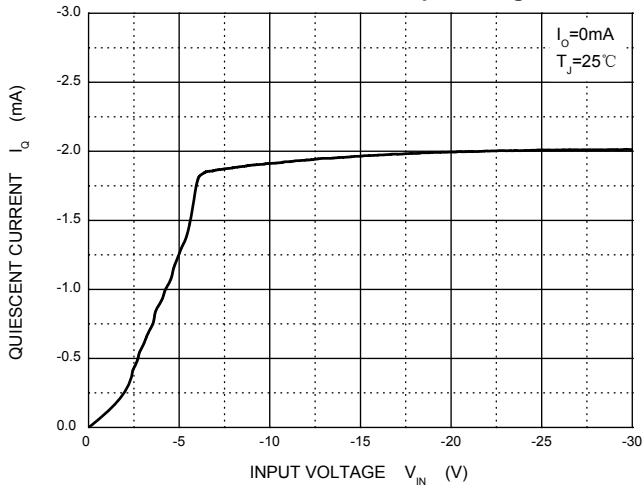

Current Cut-off Grid Voltage

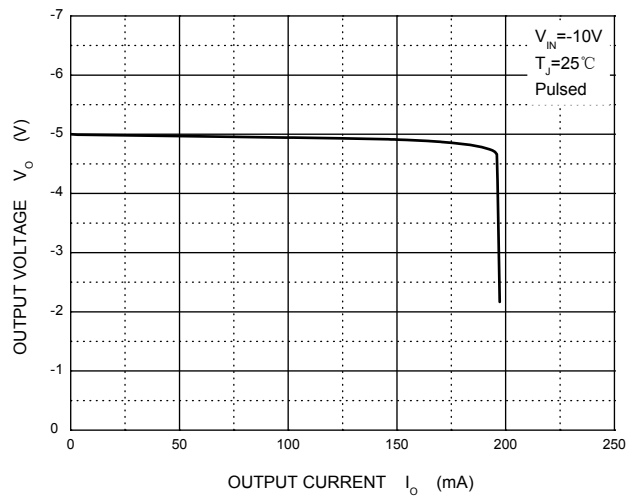

Output Voltage vs Junction Temperature

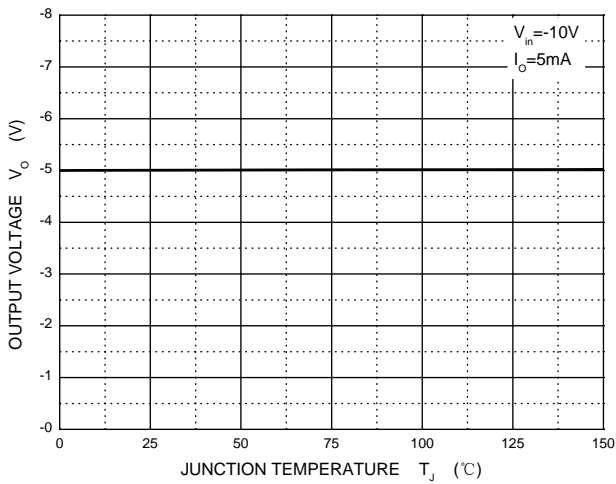

Power Derating Curve

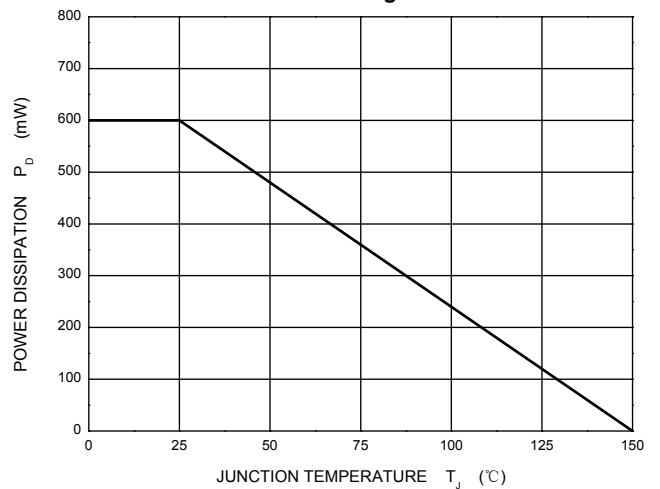

**Outlitne Drawing**

**SOT-89-3L Package Outline Dimensions**

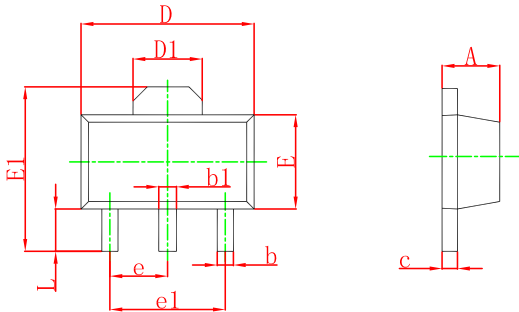

Symbol	Dimensions In Millimeters		Dimensions In Inches	
	Min	Max	Min	Max
A	1.400	1.600	0.055	0.063
b	0.320	0.520	0.013	0.020
b1	0.400	0.580	0.016	0.023
c	0.350	0.440	0.014	0.017
D	4.400	4.600	0.173	0.181
D1	1.550 REF.		0.061 REF.	
E	2.300	2.600	0.091	0.102
E1	3.940	4.250	0.155	0.167
e	1.500 TYP.		0.060 TYP.	
e1	3.000 TYP.		0.118 TYP.	
L	0.900	1.200	0.035	0.047

**SOT-89-3L Suggested Pad Layout**

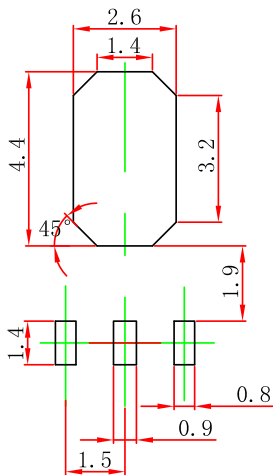

- Note:
1. Controlling dimension: in/millimeters.
  2. General tolerance: ±0.05mm.
  3. The pad layout is for reference purposes only.

**PACKAGE SPECIFICATIONS**

Package	Reel Size	Reel DIA. (mm)	Q'TY/Reel (pcs)	Box Size (mm)	QTY/Box (pcs)	Carton Size (mm)	G.W.(Kg)
SOT-89-3L	7'	330	1000	203×203×195	40000	438×438×220	180000

**Important Notice and Disclaimer**

Microdiode Electronics (Jiangsu) reserves the right to make changes to this document and its products and specifications at any time without notice. Customers should obtain and confirm the latest product information and specifications before final design, purchase or use.

Microdiode Electronics (Jiangsu) makes no warranty, representation or guarantee regarding the suitability of its products for any particular purpose, not does Microdiode Electronics (Jiangsu) assume any liability for application assistance or customer product design. Microdiode Electronics (Jiangsu) does not warrant or accept any liability with products which are purchased or used for any unintended or unauthorized application.

No license is granted by implication or otherwise under any intellectual property rights of Microdiode Electronics (Jiangsu).

Microdiode Electronics (Jiangsu) products are not authorized for use as critical components in life support devices or systems without express written approval of Microdiode Electronics (Jiangsu).