



8202A DYNAMIC RAM CONTROLLER

- Provides All Signals Necessary to Control 2117, or 2118 Dynamic Memories
- Directly Addresses and Drives Up to 64K Bytes Without External Drivers
- Provides Address Multiplexing and Strobes
- Provides a Refresh Timer and a Refresh Counter
- Refresh Cycles May be Internally or Externally Requested
- Provides Transparent Refresh Capability
- Fully Compatible with Intel® 8080A, 8085A, iAPX 88, and iAPX 86 Family Microprocessors
- Decodes CPU Status for Advanced Read Capability with the 8202A-1 or 8202A-3
- Provides System Acknowledge and Transfer Acknowledge Signals
- Internal Clock Capability with the 8202A-1 or 8202A-3

The Intel® 8202A is a Dynamic Ram System Controller designed to provide all signals necessary to use 2117 or 2118 Dynamic RAMs in microcomputer systems. The 8202A provides multiplexed addresses and address strobes, as well as refresh/access arbitration. The 8202A-1 or 8202A-3 support an internal crystal oscillator.

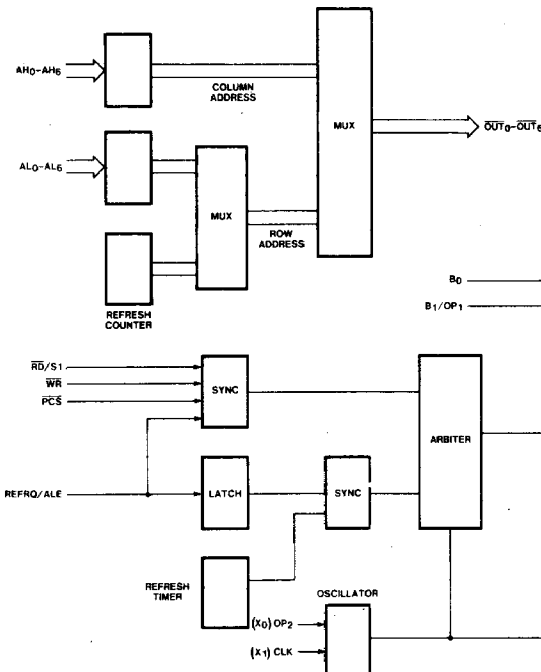

Figure 1. 8202A Block Diagram

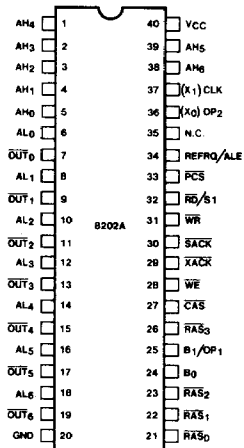

Figure 2. Pin Configuration

Table 1. Pin Descriptions

Symbol	Pin No.	Type	Name and Function
AL ₀	6	I	Address Low: CPU address inputs used to generate memory row address.
AL ₁	8	I	
AL ₂	10	I	
AL ₃	12	I	
AL ₄	14	I	
AL ₅ AL ₆	16 18	I	
AH ₀	5	I	Address High: CPU address inputs used to generate memory column address.
AH ₁	4	I	
AH ₂	3	I	
AH ₃	2	I	
AH ₄	1	I	
AH ₅ AH ₆	39 38	I	
BO B ₁ /OP ₁	24 25	I	Bank Select Inputs: Used to gate the appropriate RAS ₀ -RAS ₃ output for a memory cycle. B ₁ /OP ₁ option used to select the Advanced Read Mode.
$\overline{\text{PCS}}$	33	I	Protected Chip Select: Used to enable the memory read and write inputs. Once a cycle is started, it will not abort even if $\overline{\text{PCS}}$ goes inactive before cycle completion.
$\overline{\text{WR}}$	31	I	Memory Write Request.
$\overline{\text{RD}}/\text{S}_1$	32	I	Memory Read Request: S ₁ function used in Advanced Read mode selected by OP ₁ (pin 25).
REFRQ/ ALE	34	I	External Refresh Request: ALE function used in Advanced Read mode, selected by OP ₁ (pin 25).
$\overline{\text{OUT}}_0$ $\overline{\text{OUT}}_1$ $\overline{\text{OUT}}_2$ $\overline{\text{OUT}}_3$ $\overline{\text{OUT}}_4$ $\overline{\text{OUT}}_5$ $\overline{\text{OUT}}_6$	7 9 11 13 15 17 19	O	Output of the Multiplexer: These outputs are designed to drive the addresses of the Dynamic RAM array. (Note that the $\overline{\text{OUT}}_{0-6}$ pins do not require inverters or drivers for proper operation.)
$\overline{\text{WE}}$	28	O	Write Enable: Drives the Write Enable inputs of the Dynamic RAM array.
CAS	27	O	Column Address Strobe: This output is used to latch the Column Address into the Dynamic RAM array.

Symbol	Pin No.	Type	Name and Function
RAS ₀ RAS ₁ RAS ₂ RAS ₃	21 22 23 26	O	Row Address Strobe: Used to latch the Row Address into the bank of dynamic RAMs, selected by the 8202A Bank Select pins (B ₀ , B ₁ /OP ₁).
XACK	29	O	
SACK	30	O	
(X ₀) OP ₂ (X ₁) CLK	38 37	I/O I/O	
N.C.	35		Reserved for future use.
VCC	40		Power Supply: +5V.
GND	20		Ground.

NOTE: Crystal mode for the 8202A-1 or 8202A-3 only.

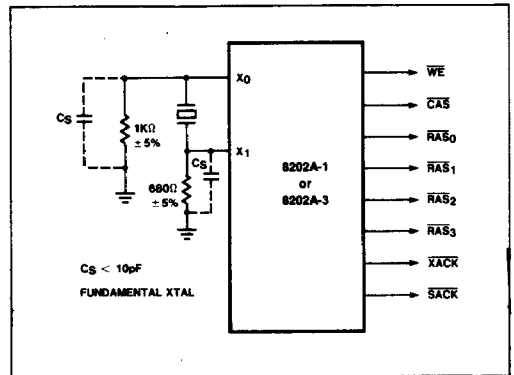

Figure 3. Crystal Operation for the 8202A-1 and the 8202A-3

Functional Description

The 8202A provides a complete dynamic RAM controller for microprocessor systems as well as expansion memory boards. All of the necessary control signals are provided for 2117 and 2118 dynamic RAMs.

All 8202A timing is generated from a single reference clock. This clock is provided via an external oscillator or an on chip crystal oscillator. All output signal transitions are synchronous with respect to this clock reference, except for the CPU handshake signals \overline{SACK} and \overline{XACK} (trailing edge).

CPU memory requests normally use the \overline{RD} and \overline{WR} inputs. The advanced READ mode allows ALE and S1 to be used in place of the \overline{RD} input.

Failsafe refresh is provided via an internal refresh timer which generates internal refresh requests. Refresh requests can also be generated via the REFRQ input.

An on-chip synchronizer/arbiter prevents memory and refresh requests from affecting a cycle in progress. The READ, WRITE, and external REFRESH requests may be asynchronous to the 8202A clock; on-chip logic will synchronize the requests, and the arbiter will decide if the requests should be delayed, pending completion of a cycle in progress.

Option Selection

The 8202A has two strapping options. When OP_1 is selected (16K mode only), pin 32 changes from an \overline{RD} input to an S1 input, and pin 34 changes from a REFREQ input to an ALE input. See "Refresh Cycles" and "Read Cycles" for more detail. OP_1 is selected by tying pin 25 to +12V through a 5.1K ohm resistor on the 8202A-1 or 8202A-3 only.

When OP_2 is selected, by connecting pin 36 to +12V through a 1K ohm resistor, pin 37 changes from a crystal input (X_1) to the CLK input for an external TTL clock.

Refresh Timer

The refresh timer is used to monitor the time since the last refresh cycle occurred. When the appropriate amount of time has elapsed, the refresh timer will request a refresh cycle. External refresh requests will reset the refresh timer.

Refresh Counter

The refresh counter is used to sequentially refresh all of

the memory's rows. The 8-bit counter is incremented after every refresh cycle.

Address Multiplexer

The address multiplexer takes the address inputs and the refresh counter outputs, and gates them onto the address outputs at the appropriate time. The address outputs, in conjunction with the \overline{RAS} and \overline{CAS} outputs, determine the address used by the dynamic RAMs for read, write, and refresh cycles. During the first part of a read or write cycle, AL_0 - AL_6 are gated to $\overline{OUT_0}$ - $\overline{OUT_6}$, then AH_0 - AH_6 are gated to the address outputs.

During a refresh cycle, the refresh counter is gated onto the address outputs. All refresh cycles are RAS-only refresh (\overline{CAS} inactive, \overline{RAS} active).

To minimize buffer delay, the information on the address outputs is inverted from that on the address inputs.

$\overline{OUT_0}$ - $\overline{OUT_6}$ do not need inverters or buffers unless additional drive is required.

Synchronizer/Arbiter

The 8202A has three inputs, REFRQ/ALE (pin 34), \overline{RD} (pin 32) and \overline{WR} (pin 31). The \overline{RD} and \overline{WR} inputs allow an external CPU to request a memory read or write cycle, respectively. The REFRQ/ALE allows refresh requests to be requested external to the 8202A.

All three of these inputs may be asynchronous with respect to the 8202A's clock. The arbiter will resolve conflicts between refresh and memory requests, for both pending cycles and cycles in progress. Read and write requests will be given priority over refresh requests.

System Operation

The 8202A is always in one of the following states:

- a) IDLE
- b) TEST Cycle
- c) REFRESH Cycle
- d) READ Cycle
- e) WRITE Cycle

The 8202A is normally in the IDLE state. Whenever one of the other cycles is requested, the 8202A will leave the IDLE state to perform the desired cycle. If no other cycles are pending, the 8202A will return to the IDLE state.

Description	Pin #	Normal Function	Option Function
B1/ OP_1	25	Bank (RAS) Select	Advanced-Read Mode (see text)
X_0 / OP_2	36	Crystal Oscillator (8202A-1 or 8202A-3)	External Oscillator

Figure 4. 8202A Option Selection

Test Cycle

The TEST Cycle is used to check operation of several 8202A internal functions. TEST cycles are requested by activating the \overline{RD} and \overline{WR} inputs, independent of PCS. The TEST Cycle will reset the refresh address counter. It will perform a WRITE Cycle if \overline{PCS} is low. The TEST Cycle should not be used in normal system operation, since it would affect the dynamic RAM refresh.

Refresh Cycles

The 8202A has two ways of providing dynamic RAM refresh:

- 1) Internal (failsafe) refresh
- 2) External (hidden) refresh

Both types of 8202A refresh cycles activate all of the \overline{RAS} outputs, while \overline{CAS} , \overline{WE} , \overline{SACK} , and \overline{XACK} remain inactive.

Internal refresh is generated by the on-chip refresh timer. The timer uses the 8202A clock to ensure that refresh of all rows of the dynamic RAM occurs every 2 milliseconds. If REFRQ is inactive, the refresh timer will request a refresh cycle every 10-16 microseconds.

External refresh is requested via the REFRQ input (pin 34). External refresh control is not available when the Advanced-Read mode is selected. External refresh requests are latched, then synchronized to the 8202A clock.

The arbiter will allow the refresh request to start a refresh cycle only if the 8202A is not in the middle of a cycle.

Simultaneous memory request and external refresh request will result in the memory request being honored first. This 8202A characteristic can be used to "hide" refresh cycles during system operation. A circuit similar to Figure 5 can be used to decode the CPU's instruction fetch status to generate an external refresh request. The refresh request is latched while the 8202A performs the instruction fetch; the refresh cycle will start immediately after the memory cycle is completed, even if the \overline{RD} input has not gone inactive. If the CPU's instruction decode time is long enough, the 8202A can complete the refresh cycle before the next memory request is generated.

Certain system configurations require complete external refresh requests. If external refresh is requested faster than the minimum internal refresh timer (t_{REF}), then, in effect, all refresh cycles will be caused by the external refresh request, and the internal refresh timer will never generate a refresh request.

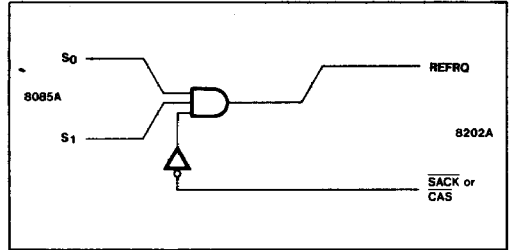

Figure 5. Hidden Refresh

Read Cycles

The 8202A can accept two different types of memory Read requests:

- 1) Normal Read, via the \overline{RD} input
- 2) Advanced Read, using the S1 and ALE inputs

The user can select the desired Read request configuration via the B1/OP1 hardware strapping option on pin 25.

	Normal Read	Advanced Read
Pin 25	B1 input	+12 Volt Option
Pin 32	RD input	S1 input
Pin 34	REFRQ input	ALE input
# RAM banks	4 (\overline{RAS} 0-3)	2 (\overline{RAS} 2-3)
Ext. Refresh Req.	Yes	No

Figure 6. 8202A Read Options

Normal Reads are requested by activating the \overline{RD} input, and keeping it active until the 8202A responds with an \overline{XACK} pulse. The \overline{RD} input can go inactive as soon as the command hold time (t_{CHS}) is met.

Advanced Read cycles are requested by pulsing ALE while S1 is active; if S1 is inactive (low) ALE is ignored. Advanced Read timing is similar to Normal Read timing, except the falling edge of ALE is used as the cycle start reference.

If a Read cycle is requested while a refresh cycle is in progress, then the 8202A will set the internal delayed-SACK latch. When the Read cycle is eventually started, the 8202A will delay the active \overline{SACK} transition until \overline{XACK} goes active, as shown in the AC timing diagrams. This delay was designed to compensate for the CPU's READY setup and hold times. The delayed-SACK latch is cleared after every READ cycle.

Based on system requirements, either \overline{SACK} or \overline{XACK} can be used to generate the CPU READY signal. \overline{XACK} will

normally be used; if the CPU can tolerate an advanced READY, then \overline{SACK} can be used, but only if the CPU can tolerate the amount of advance provided by \overline{SACK} . If \overline{SACK} arrives too early to provide the appropriate number of WAIT states, then either \overline{XACK} or a delayed form of \overline{SACK} should be used.

Write Cycles

Write cycles are similar to Normal Read cycles, except for the \overline{WE} output. \overline{WE} is held inactive for Read cycles, but goes active for Write cycles. All 8202A Write cycles are "early-write" cycles; \overline{WE} goes active before \overline{CAS} goes active by an amount of time sufficient to keep the dynamic RAM output buffers turned off.

General System Considerations

All memory requests (Normal Reads, Advanced Reads, Writes) are qualified by the \overline{PCS} input. \overline{PCS} should be stable, either active or inactive, prior to the leading edge of \overline{RD} , \overline{WR} , or ALE. Systems which use battery backup should pullup \overline{PCS} to prevent erroneous memory requests, and should also pullup \overline{WR} to keep the 8202A out of its test mode.

In order to minimize propagation delay, the 8202A uses an inverting address multiplexer without latches. The system must provide adequate address setup and hold times to guarantee \overline{RAS} and \overline{CAS} setup and hold times for the RAM. The 8202A t_{AD} AC parameter should be used for this system calculation.

The B0-B1 inputs are similar to the address inputs in that they are not latched. B0 and B1 should not be changed during a memory cycle, since they directly control which \overline{RAS} output is activated.

The 8202A uses a two-stage synchronizer for the memory request inputs (\overline{RD} , \overline{WR} , ALE), and a separate two stage synchronizer for the external refresh input (REFRQ). As with any synchronizer, there is always a finite probability of metastable states inducing system errors. The 8202A synchronizer was designed to have a system error rate less than 1 memory cycle every three years based on the full operating range of the 8202A.

A microprocessor system is concerned with the time data is valid after \overline{RD} goes low. See Figure 7. In order to calculate memory read access times, the dynamic RAM's A.C. specifications must be examined, especially the RAS-access time (t_{RAC}) and the CAS-access time (t_{CAC}). Most configurations will be CAS-access limited; i.e., the data from the RAM will be stable $t_{cc,max}$ (8202A) + t_{CAC} (RAM) after a memory read cycle is started. Be sure to add any delays (due to buffers, data latches, etc.) to calculate the overall read access time.

Since the 8202A normally performs "early-write" cycles, the data must be stable at the RAM data inputs by the time \overline{CAS} goes active, including the RAM's data setup time. If the system does not normally guarantee sufficient write data setup, you must either delay the \overline{WR} input signal or delay the 8202A \overline{WE} output.

Delaying the \overline{WR} input will delay all 8202A timing, including the READY handshake signals, \overline{SACK} and \overline{XACK} , which may increase the number of WAIT states generated by the CPU.

If the \overline{WE} output is externally delayed beyond the \overline{CAS} active transition, then the RAM will use the falling edge of \overline{WE} to strobe the write data into the RAM. This \overline{WE} transition should not occur too late during the CAS active transition, or else the \overline{WE} to \overline{CAS} requirements of the RAM will not be met.

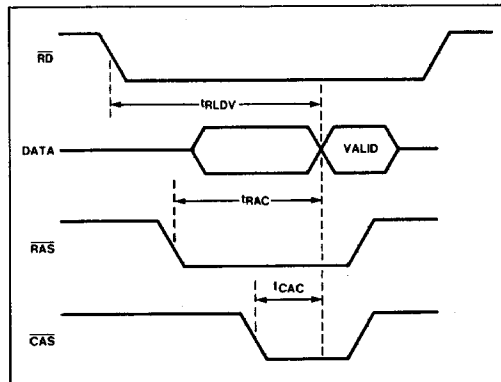

Figure 7. Read Access Time

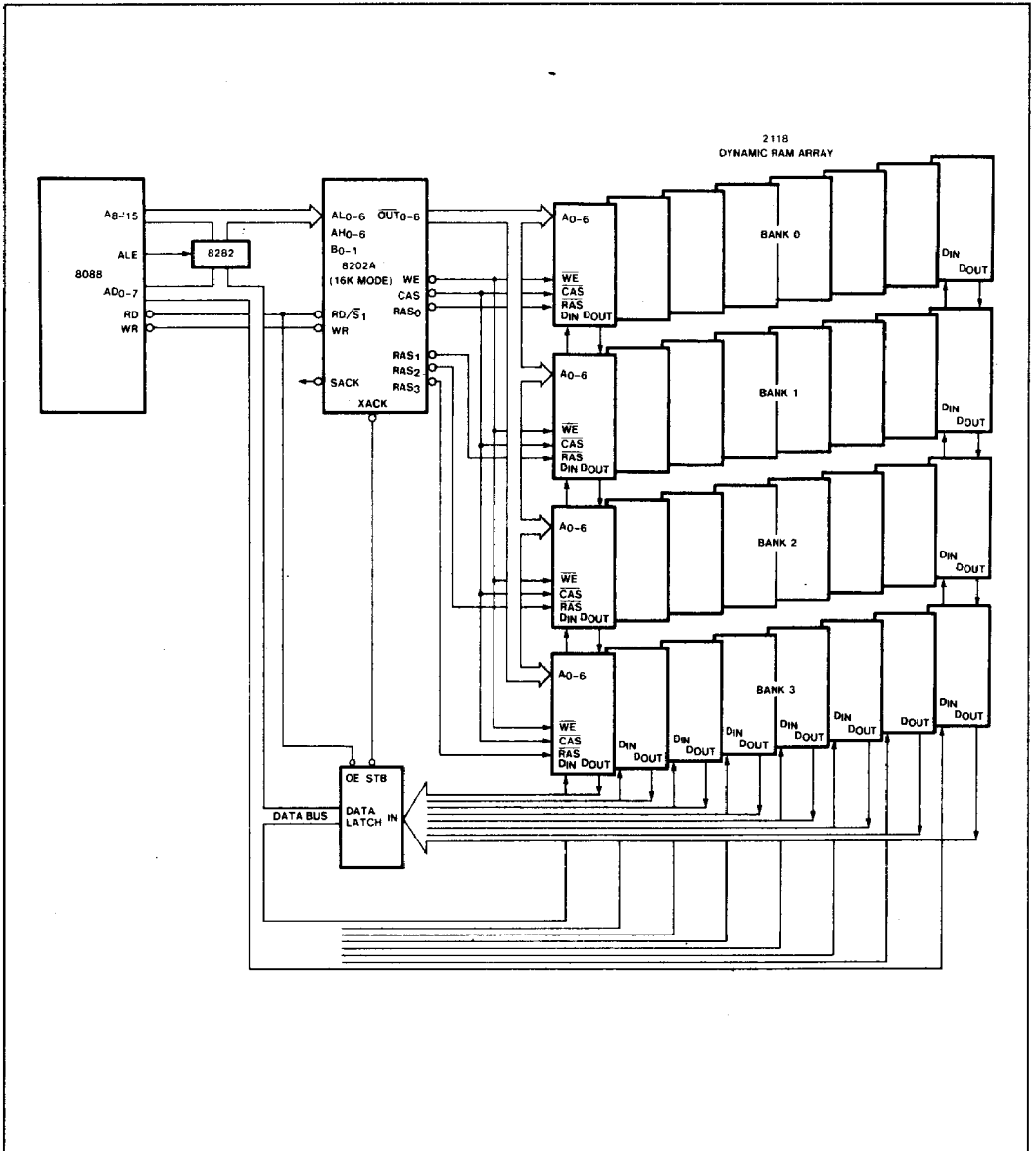

Figure 8. Typical 8088 System

ABSOLUTE MAXIMUM RATINGS*

Ambient Temperature Under Bias 0°C to 70°C
 Storage Temperature -65°C to +150°C
 Voltage On any Pin
 With Respect to Ground -0.5V to +7V⁴
 Power Dissipation 1.5 Watts

**NOTE: Stresses above those listed under "Absolute Maximum Ratings" may cause permanent damage to the device. This is a stress rating only and functional operation of the device at these or any other conditions above those indicated in the operational sections of this specification is not implied. Exposure to absolute maximum rating conditions for extended periods may affect device reliability.*

D.C. CHARACTERISTICS $T_A = 0^\circ\text{C to } 70^\circ\text{C}; V_{CC} = 5.0\text{V} \pm 10\%, V_{CC} = 5.0\text{V} \pm 5\%$ for 8202A-3, GND = 0V

Symbol	Parameter	Min	Max	Units	Test Conditions
V _C	Input Clamp Voltage		-1.0	V	I _C = -5 mA
I _{CC}	Power Supply Current		270	mA	
I _F	Forward Input Current CLK All Other Inputs ³		-2.0 -320	mA μA	V _F = 0.45V V _F = 0.45V
I _R	Reverse Input Current ³		40	μA	V _R = V _{CC} (Note 1)
V _{OL}	Output Low Voltage SACK, XACK All Other Outputs		0.45 0.45	V V	I _{OL} = 5 mA I _{OL} = 3 mA
V _{OH}	Output High Voltage SACK, XACK All Other Outputs	2.4 2.6		V V	V _{IL} = 0.85V I _{OH} = -1 mA I _{OH} = -1 mA
V _{IL}	Input Low Voltage		0.8	V	V _{CC} = 5.0V (Note 2)
V _{IH1}	Input High Voltage	2.0		V	V _{CC} = 5.0V
V _{IH2}	Option Voltage			V	(Note 4)
C _{IN}	Input Capacitance		30	pF	F = 1 MHz V _{BIAS} = 2.5V, V _{CC} = 5V T _A = 25°C

NOTES:

- I_R = 200μA for pin 37 (CLK) for external clock mode.
- For test mode RD & WR must be held at GND.
- Except for pin 36.
- 8202A-1 and 8202A-3 supports both OP₁ and OP₂. 8202A only supports OP₂.

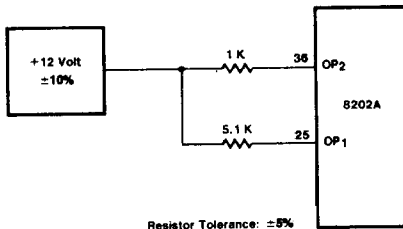

A.C. CHARACTERISTICS
 $T_A = 0^\circ\text{C to } 70^\circ\text{C}, V_{CC} = 5V \pm 10\%, V_{CC} = 5V \pm 5\%$ for 8202A-3

 Measurements made with respect to $\overline{\text{RAS}}_0$ - $\overline{\text{RAS}}_3$, $\overline{\text{CAS}}$, $\overline{\text{WE}}$, $\overline{\text{OUT}}_0$ - $\overline{\text{OUT}}_6$ are at 2.4V and 0.8V. All other pins are measured at 1.5V. All times are in nsec.

Symbol	Parameter	Min	Max	Notes
t_p	Clock Period	40	54	
t_{PH}	External Clock High Time	20		
t_{PL}	External Clock Low Time—above (>) 20 mHz	17		
t_{PL}	External Clock Low Time—below (<) 20 mHz	20		
t_{RC}	Memory Cycle Time	10tp - 30	12tp	4, 5
t_{REF}	Refresh Time (128 cycles—16K mode)	264tp	288tp	
t_{RP}	$\overline{\text{RAS}}$ Precharge Time	4tp - 30		
t_{RSH}	$\overline{\text{RAS}}$ Hold After $\overline{\text{CAS}}$	5tp - 30		3
t_{ASR}	Address Setup to $\overline{\text{RAS}}$	tp - 30		3
t_{RAH}	Address Hold From $\overline{\text{RAS}}$	tp - 10		3
t_{ASC}	Address Setup to $\overline{\text{CAS}}$	tp - 30		3
t_{CAH}	Address Hold from $\overline{\text{CAS}}$	5tp - 20		3
t_{CAS}	$\overline{\text{CAS}}$ Pulse Width	5tp - 10		
t_{WCS}	$\overline{\text{WE}}$ Setup to $\overline{\text{CAS}}$	tp - 40		
t_{WCH}	$\overline{\text{WE}}$ Hold After $\overline{\text{CAS}}$	5tp - 35		8
t_{RS}	$\overline{\text{RD}}$, $\overline{\text{WR}}$, ALE, REFRQ delay from $\overline{\text{RAS}}$	5tp		
t_{MRP}	$\overline{\text{RD}}$, $\overline{\text{WR}}$ setup to $\overline{\text{RAS}}$	0		5
t_{RMS}	REFRQ setup to $\overline{\text{RD}}$, $\overline{\text{WR}}$	2tp		
t_{RMP}	REFRQ setup to $\overline{\text{RAS}}$	2tp		5
t_{PCS}	$\overline{\text{PCS}}$ Setup to $\overline{\text{RD}}$, $\overline{\text{WR}}$, ALE	20		
t_{AL}	S1 Setup to ALE	15		
t_{LA}	S1 Hold from ALE	30		
t_{CR}	$\overline{\text{RD}}$, $\overline{\text{WR}}$, ALE to $\overline{\text{RAS}}$ Delay	tp + 30	2tp + 70	2
t_{CC}	$\overline{\text{RD}}$, $\overline{\text{WR}}$, ALE to $\overline{\text{CAS}}$ Delay	3tp + 25	4tp + 85	2
t_{SC}	CMD Setup to Clock	15		1
t_{MRS}	$\overline{\text{RD}}$, $\overline{\text{WR}}$ setup to REFRQ	5		
t_{CA}	$\overline{\text{RD}}$, $\overline{\text{WR}}$, ALE to $\overline{\text{SACK}}$ Delay		2tp + 47	2, 9
t_{CX}	$\overline{\text{CAS}}$ to $\overline{\text{XACK}}$ Delay	5tp - 25	5tp + 20	
t_{CS}	$\overline{\text{CAS}}$ to $\overline{\text{SACK}}$ Delay	5tp - 25	5tp + 40	2, 10
t_{ACK}	$\overline{\text{XACK}}$ to $\overline{\text{CAS}}$ Setup	10		
t_{XW}	$\overline{\text{XACK}}$ Pulse Width	tp - 25		7
t_{CK}	$\overline{\text{SACK}}$, $\overline{\text{XACK}}$ turn-off Delay		35	
t_{KCH}	CMD Inactive Hold after $\overline{\text{SACK}}$, $\overline{\text{XACK}}$	10		
t_{LL}	REFRQ Pulse Width	20		
t_{CHS}	CMD Hold Time	30		11
t_{RFR}	REFRQ to $\overline{\text{RAS}}$ Delay		4tp + 100	6
t_{WW}	$\overline{\text{WR}}$ to $\overline{\text{WE}}$ Delay	0	50	8
t_{AD}	CPU Address Delay	0	40	3

WAVEFORMS

Normal Read or Write Cycle

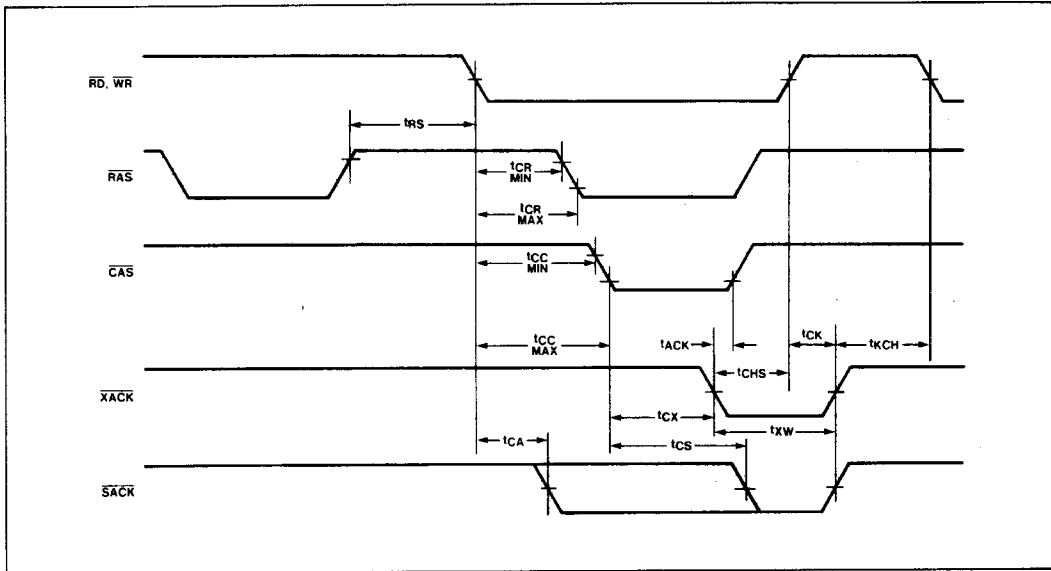

Advanced Read Mode

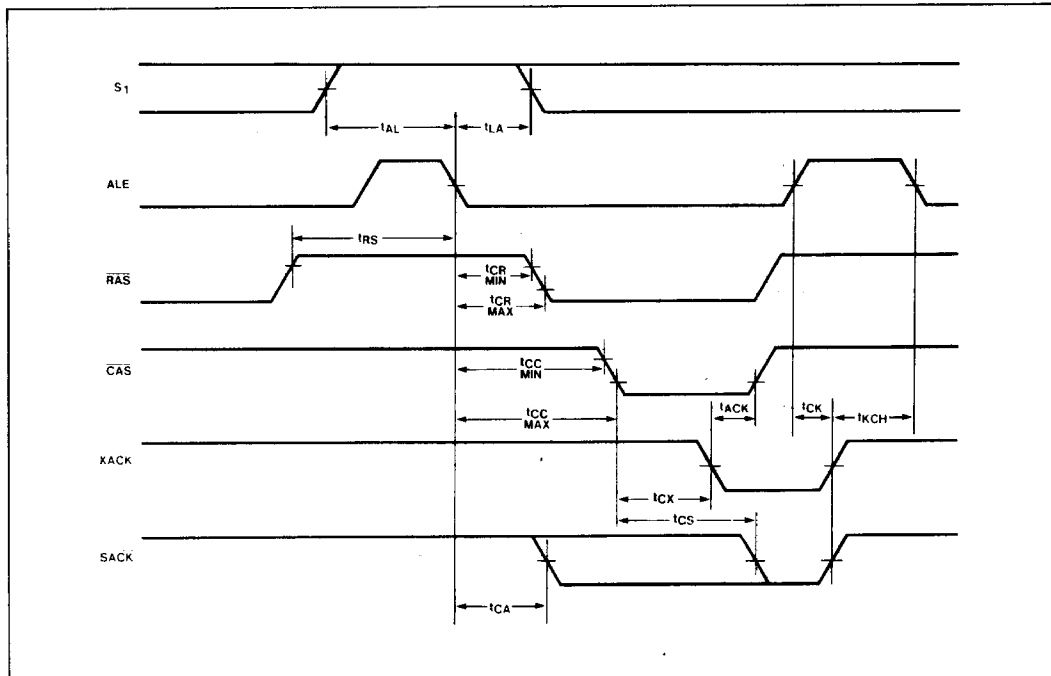

WAVEFORMS (cont'd)

Memory Compatibility Timing

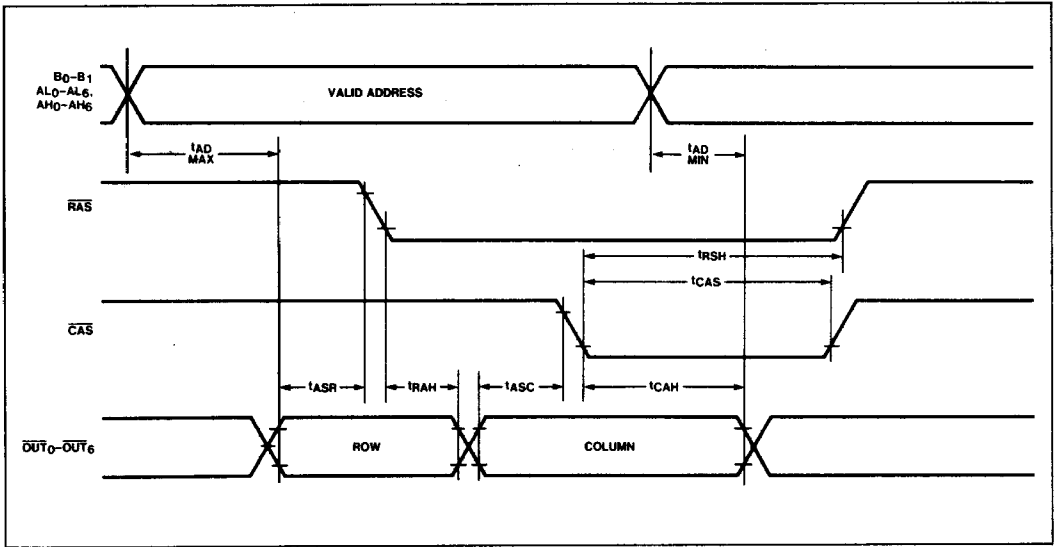

Write Cycle Timing

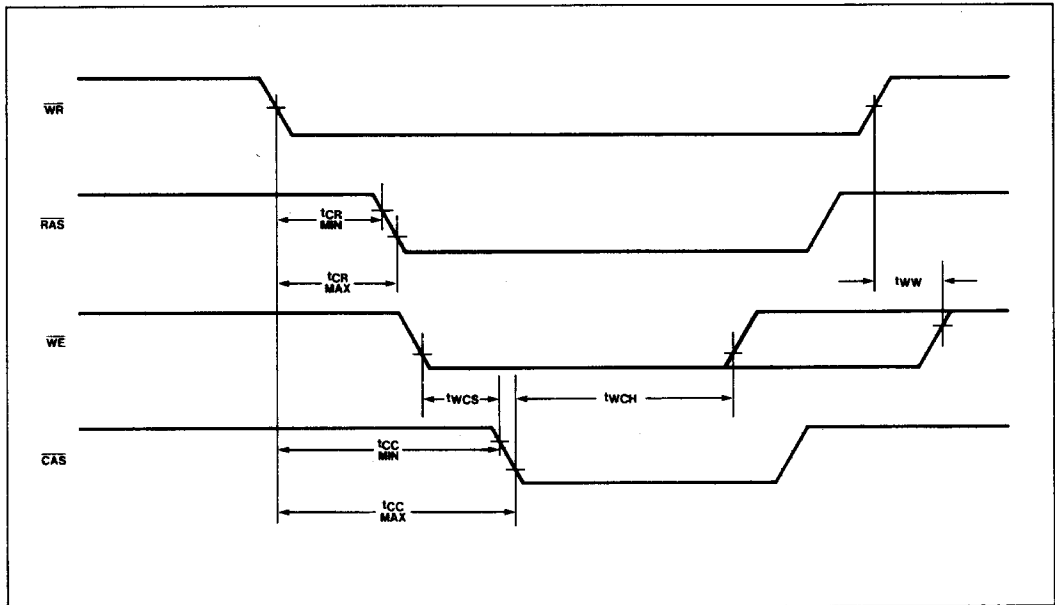

WAVEFORMS (cont'd)

Read or Write Followed By External Refresh

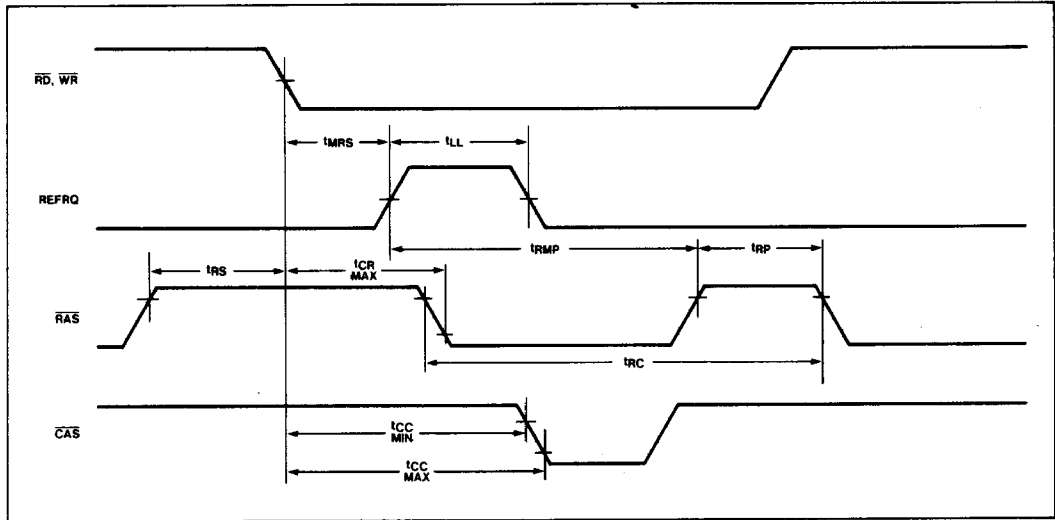

External Refresh Followed By Read or Write

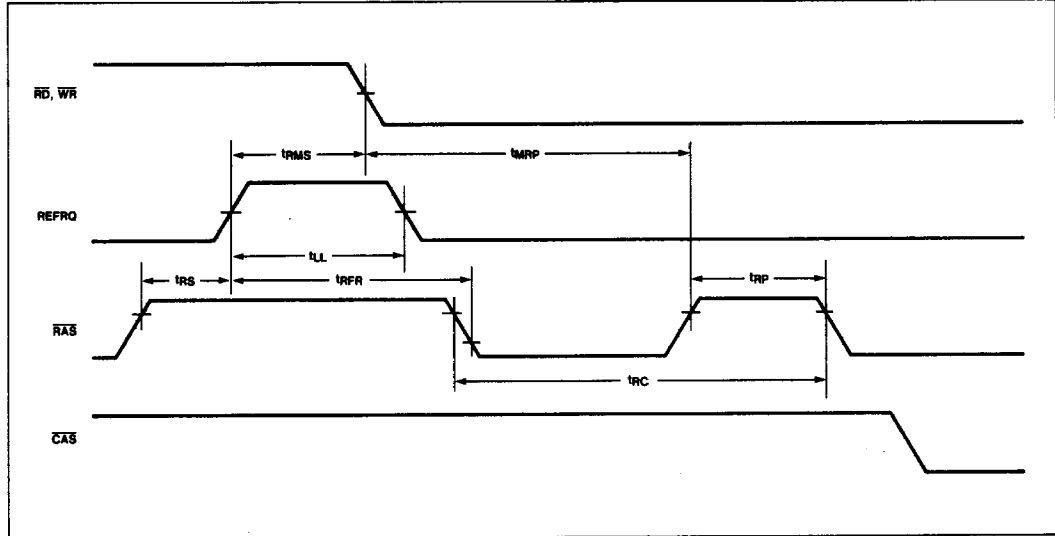

WAVEFORMS (cont'd)

Clock And System Timing

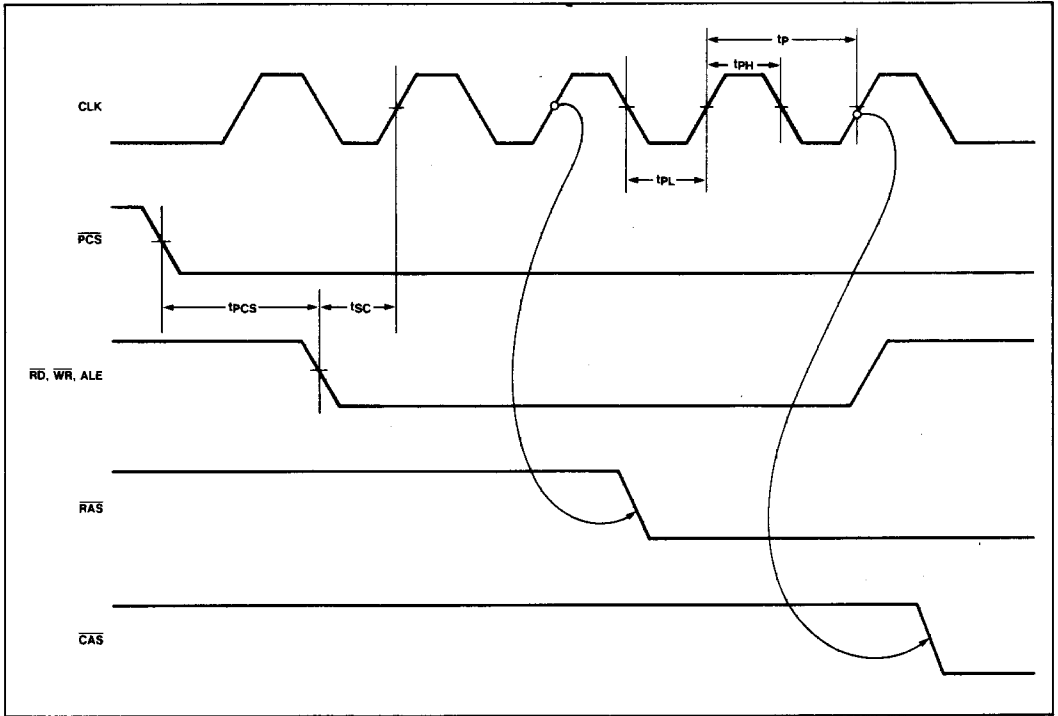

Table 2 8202A Output Test Loading.

Pin	Test Load
\overline{SACK} , \overline{XACK}	$C_L = 30 \text{ pF}$
$\overline{OUT}_0 - \overline{OUT}_6$	$C_L = 160 \text{ pF}$
$\overline{RAS}_0 - \overline{RAS}_3$	$C_L = 60 \text{ pF}$
\overline{WE}	$C_L = 224 \text{ pF}$
CAS	$C_L = 320 \text{ pF}$

NOTES:

- t_{SC} is a reference point only. ALE, \overline{RD} , \overline{WR} , and REFRQ inputs do not have to be externally synchronized to 8202A clock.
- If t_{RS} min and t_{MS} min are met then, t_{CA} , t_{CR} , and t_{CC} are valid, otherwise t_{CS} is valid.
- t_{ASR} , t_{RAH} , t_{ASC} , t_{CAH} , and t_{RSH} depend upon B0-B1 and CPU address remaining stable throughout the memory cycle. The address inputs are not latched by the 8202A.
- For back-to-back refresh cycles, t_{RC} max = 13tp
- t_{RC} max is valid only if t_{RMP} min is met (READ, WRITE followed by REFRESH) or t_{MRP} min is met (REFRESH followed by READ, WRITE).
- t_{RFR} is valid only if t_{RS} min and t_{MS} min are met.
- t_{XW} min applies when \overline{RD} , \overline{WR} has already gone high. Otherwise \overline{XACK} follows \overline{RD} , \overline{WR} .
- \overline{WE} goes high according to t_{WCH} or t_{WW} , whichever occurs first.

A.C. TESTING LOAD CIRCUIT

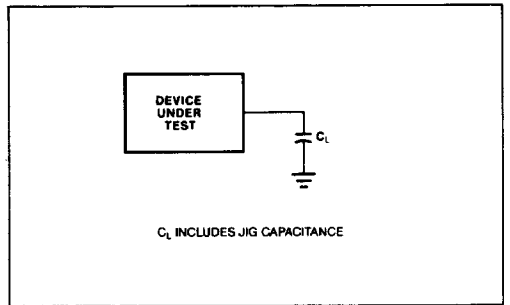

- t_{CA} applies only when in normal \overline{SACK} mode.
- t_{CS} applies only when in delayed \overline{SACK} mode.
- t_{CHS} must be met only to ensure a \overline{SACK} active pulse when in delayed \overline{SACK} mode. \overline{XACK} will always be activated for at least t_{XW} ($t_p - 25 \text{ nS}$). Violating t_{CHS} min does not otherwise affect device operation.

The typical rising and falling characteristic curves for the $\overline{\text{OUT}}$, $\overline{\text{RAS}}$, $\overline{\text{CAS}}$ and $\overline{\text{WE}}$ output buffers can be used to determine the effects of capacitive loading on the A.C.

Timing Parameters. Using this design tool in conjunction with the timing waveforms, the designer can determine typical timing shifts based on system capacitive load.

A.C. CHARACTERISTICS FOR DIFFERENT CAPACITIVE LOADS

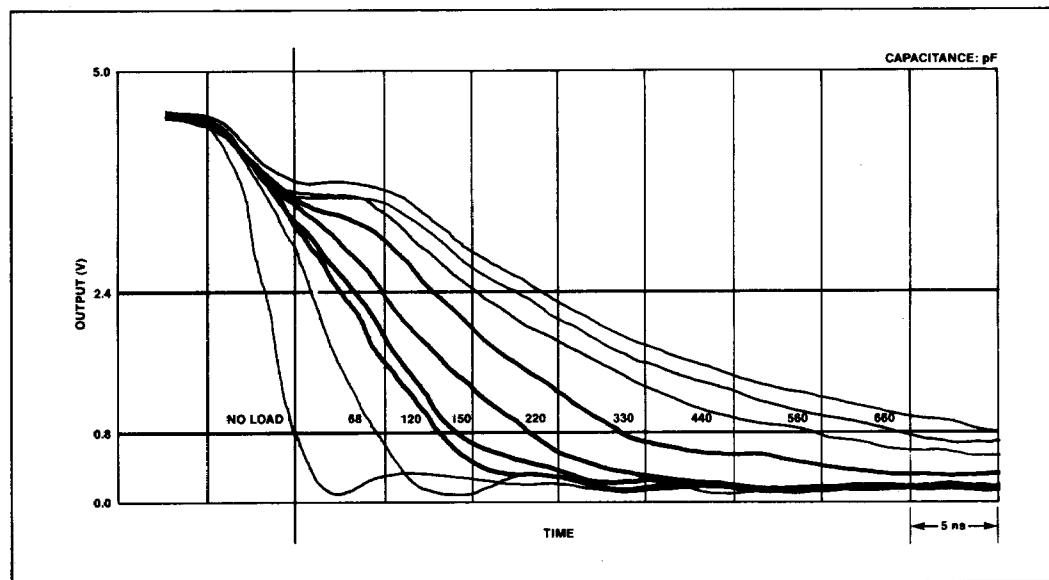
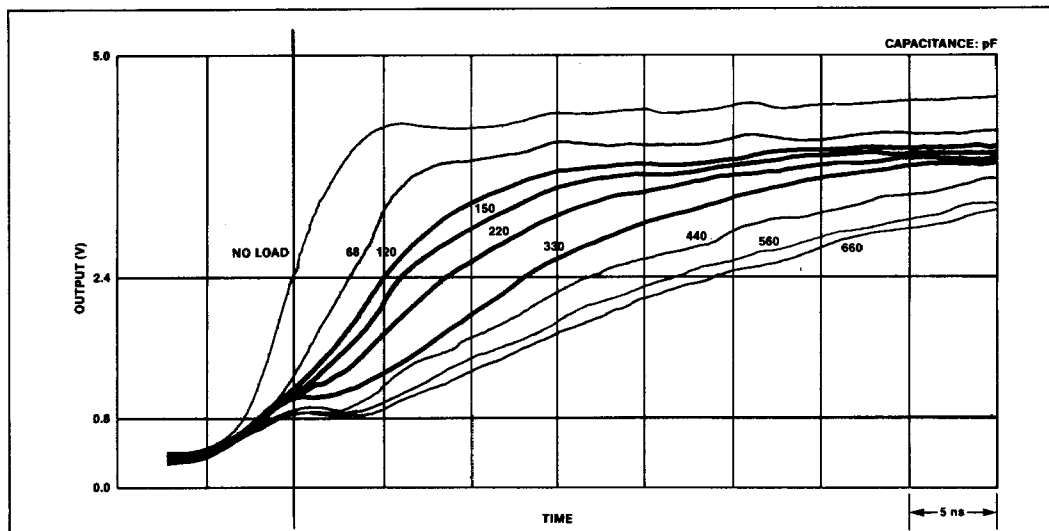

NOTE:
Use the Test Load as the base capacitance for estimating timing shifts for system critical timing parameters.

MEASUREMENT CONDITIONS:
 $T_A = 25^\circ\text{C}$ Pins not measured are loaded with the
 $V_{CC} = +5\text{V}$ Test Load capacitance.
 $t_p = 50 \text{ ns}$

Example: Find the effect on t_{CR} and t_{CC} using 64 2118 Dynamic RAMs configured in 4 banks.

1. Determine the typical RAS and CAS capacitance:
From the data sheet RAS = 4 pF and CAS = 4 pF.
∴ RAS load = 64 pF + board capacitance.
CAS load = 256 pF + board capacitance.
Assume 2 pF/in (trace length) for board capacitance.
2. From the waveform diagrams, we determine that the falling edge timing is needed for t_{CR} and t_{CC} .
Next find the curve that *best* approximates the test load; i.e., 68 pF for RAS and 330 pF for CAS.
3. If we use 72 pF for RAS loading, then the t_{CR} (max.) spec should be increased by *about* 1 ns. Similarly if we use 288 pF for CAS, then t_{CC} (min.) and (max.) should decrease about 1 ns.