



Quality Thermistor, Inc.



QTI™ THERMISTORS AND ENGINEERING SERVICES



www.thermistor.com

INDUSTRY'S PARTNER IN QUALITY AND PERFORMANCE™

OUR MISSION: Through teamwork, to achieve industry's confidence as the highest quality producer of thermistors in the world.

CONTENTS

QTI THERMISTORS	3
NTC THERMISTORS	
NTC Leaded Thermistors	5
NTC High Temp Thermistors	11
NTC Surface Mount Thermistors	12
NTC Military Grade Thermistors	15
R/T Characteristics of NTC Thermistors	18-20
PTC THERMISTORS	
PTC Surface Mount Thermistors	22
PTC Chip Thermistors	23
PTC Military Grade Thermistors	25
APPENDIX	
Basic Temperature Measurement	28
Temperature Compensation	28
Computer Interfacing to an NTC Thermistor	29
SPECIAL SERVICES	31

THERMISTOR PROBE DESIGN GUIDE

Quality Thermistor provides a wide variety of NTC Thermistor based temperature probes. The QTI® Temperature Probe Design Guide is available to assist the design Engineer in crafting the best temperature probe design for their application. The Temperature Probe Design Guide is available for download at www.thermistor.com/probedesignguide.pdf

For a hard copy of the Temperature Probe Design Guide contact your local Quality Thermistor representative, or call QTI directly at 800-554-4784.



Thermistors

Thermistor Technologies

Thermistors (THERMally sensitive resISTORS) are solid state, electronic devices which detect thermal environmental changes for use in TEMPERATURE measurement, control and compensation circuitry. Quality Thermistor, Inc. manufactures sensors comprising the two basic thermistor technologies:

Positive Temperature Coefficient (PTC) thermistors exhibit increasing electrical resistance with increases in environmental temperature and decreasing electrical resistance with decreasing temperature. The PTC's linear and proportional change in Resistance vs. Temperature (R-T) offers simplified and reliable thermal management.

Negative Temperature Coefficient (NTC) thermistors exhibit decreasing electrical resistance with increases in environmental temperature and increasing electrical resistance with decreasing temperature. The NTC's exponential and inverse R-T output delivers precise, repeatable thermal sensing with field interchangeable capability.

For further engineering information on how to utilize QTI™ brand PTC and NTC thermistors in your application, refer to pages 28 through 30 of your Quality Thermistor, Inc. catalog.

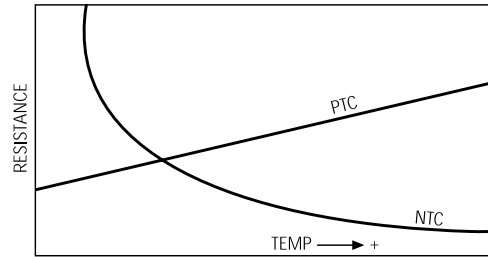

Why QTI™ Thermistors?

Since 1977, Quality Thermistor, Inc., has designed and manufactured PTC and NTC thermistors of superior quality. From off-the-shelf thermistor temperature sensors to custom temperature probes, QTI™ brand temperature sensing products have been specified for mission critical applications from deep below the oceans' surfaces to the outer reaches of space.











Your Quality Thermistor catalog has been thoughtfully designed to address industry's temperature sensing requirements. Whether you are searching for innovative and reliable HVAC & R moisture resistant thermistor probes or leading edge surface mount technology for Telecom, Quality Thermistor, Inc. has your solution.

While we trust that the information provided within your catalog will assist you in the selection of the appropriate thermistor temperature sensor, there is no substitute for candid, one-to-one dialog. We encourage you to contact the Quality Thermistor, Inc. factory or field sales representative in your area to discuss your specific design, sales or customer support needs. Thank you!

- High-quality PTC and NTC thermistors and probes
- Full staff of engineers
- Mirrored manufacturing locations
- Mil-Grade, mission-critical devices
- Exclusive PTC Surface Mount offering
- Largest selection of NTC resistance values
- Patented NTC surface mount technology
- Exclusive Hydroguard™ thermistors
- Custom probe design
- Short-run production
- In-house test lab
- Quick prototype samples
- Worldwide distribution

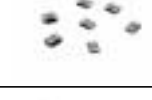

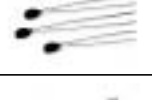
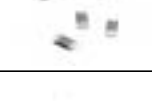
NTC THERMISTORS DIRECTORY

Product Image	Catalog Page	Description	Part Series	Available Tolerances	Mil-Spec Equivalent	KeyFeatures	Typical Applications
	5	Epoxy Coated	QTMC	1%, 2%, 5%, 10%	RTH44	"Point Matched" tolerances available at temperatures other than 25C, wide range of R/T curves available	Board level temperature measurement & compensation
	6	Glass Encapsulated NTC Thermistors	QTGB	Interchangeable to +/- .1C	N/A	Hermetic Glass Seal, +300C operating temperature, high stability	Medical applications, high moisture applications military/aerospace
	7	Epoxy Coated with Insulated Leads	QTMC QTMCB QTMCC	1%, 2%, 5%, 10%	N/A	Many lead lengths and insulation materials available, suitable for temperature probe designs	Remote Temperature Sensing & Control, ideal for enclosures
	8	Miniature Epoxy coated	QTMB	Interchangeable to +/- .2C	N/A	.038" bead diameter, less than 1 second time response in still air.	Medical & Industrial applications
	9	Epoxy Coated, Bare Leads	QTL	From 0 – 70°C +/- 1°, .5°, .2° and .1°	N/A	High Accuracy Temperature measurement	Board level temperature measurement and compensation
	10	Epoxy Coated with Insulated Leads	QTLCA QTLCB QTLCC	From 0 – 70°C +/- 1°, .5°, .2° and .1°	N/A	Many lead length and insulation material options available	High Accuracy Temperature Measurement, remote sensing, probe applications
	11	High-Temperature Epoxy Beads	QHT	+/- 5%, 10%, @ 150C	N/A	+250C intermittent, +200C operating temperature	Overtmp protection in electric motor windings
	12, 13	EIA standard package, Surface Mount Thermistor	QT1206 QT0805 QT0603	1%, 2%, 5%, 10%	M32192/5 M32192/4	Glass passivated, barrier plated, end band terminations	Board level temperature compensation & control. Gold & Lead-Free terminations avail.
	14	Wire bondable hybrid package	QTC11	1%, 2%, 5%, 10%	M32192/3	Gold or Silver terminations available, small size, fast time response	Board level temperature compensation & control.
	15	High dielectric cap	RTH06	1%, 2%, 5%, 10%		Military grade part per MIL-PRF-23648/1	Board level temperature measurement & compensation
	15	Epoxy Coated	RTH44	1%, 2%, 5%, 10%		Military grade part per MIL-PRF-23648/20	Board level temperature measurement & compensation
	16	EIA standard 0805 package	M32192/4	1%, 2%, 5%, 10%		High reliability, Military grade surface mount NTC thermistor	Board level temperature measurement and compensation. Gold terminations avail.
	17	Wire bondable hybrid package	M32192/3	1%, 2%, 5%, 10%		High reliability Military grade, gold or silver terminations	Board level temperature measurement and compensation

Standard

Quality Thermistor's bare leaded NTC thermistors are the ideal solution for low cost temperature measurement between the range of -55°C to $+150^{\circ}\text{C}$. Their small size allows for PC board mounting as well as for potting into enclosures.

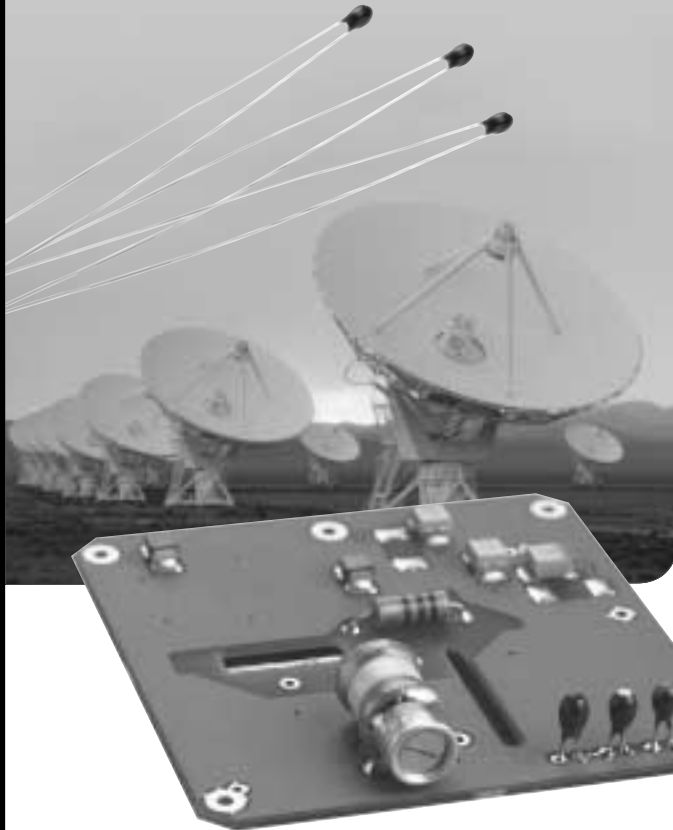

Typical installation in TCXO (temperature compensated crystal oscillator) application

Device Features

- Resistance values from 100 Ohms to 9.8 M Ohms
- Epoxy Coating
- Typical Dissipation Constant = $2\text{mw}/^{\circ}\text{C}$ in still air
- Typical time constant in still air = 10 Seconds
- #28 AWG tin/lead plated copper leads
- Interchangeable tolerances available

Custom Configurations

Quality Thermistor offers one of the largest selections of Resistance vs. Temperature Curves in the industry. Many custom Resistance/Curve configurations are available. Insulated leads are also available. Contact Technical Support for all of your special requirements.

Standard Configuration

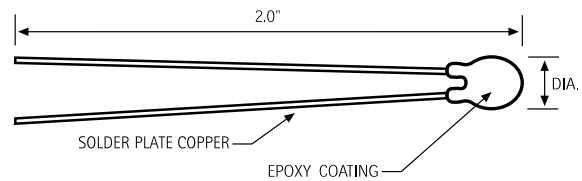

Ordering Information

QTMC-14J

- Tolerance Code
 - Part Number
- Tolerance:**
- K = 10%
 - J = 5%
 - G = 2%
 - F = 1%

RESISTANCE @ 25°C (OHMS)	PART NUMBER	R-T CURVE	ALPHA (β) @ 25°C	BEAD DIA. (IN)
100	QTMC-78	X	(-3.1%)	.125
1,000	QTMC-2	Z	(-4.4%)	.125
1,000	QTMC-27	Y	(-3.9%)	.095
2,000	QTMC-28	Y	(-3.9%)	.095
2,252	QTMC-7	Z	(-4.4%)	.095
3,000	QTMC-9	Z	(-4.4%)	.095
5,000	QTMC-11	Z	(-4.4%)	.095
10,000	QTMC-14	Z	(-4.4%)	.095
20,000	QTMC-19	Z	(-4.4%)	.095
100,000	QTMC-43	V	(-4.9%)	.095
1.0 Meg	QTMC-65	P	(-5.4%)	.095
9.8 Meg	QTMC-70	R	(-6.2%)	.095

NTC Leaded Thermistors

Glass Encapsulated

Quality Thermistor glass-bead NTC thermistors are designed for high-stability applications where reliability, repeatability, and/or high moisture resistance are crucial.

These QTGB series thermistors are designed for the harshest of environments, and virtually eliminate the concern of moisture related failure. The QTGB series is one of very few interchangeable offerings in the industry with up to +/- .1°C accuracy.

The QTI glass-bead interchangeable thermistor has an ultra-tight tolerance guaranteed to track the specified resistance/temperature curve.

Internal Quality Conformance Inspection testing ensures that these QTGB thermistors will meet or exceed the stringent requirements of qualification testing per MIL-PRF-23648.

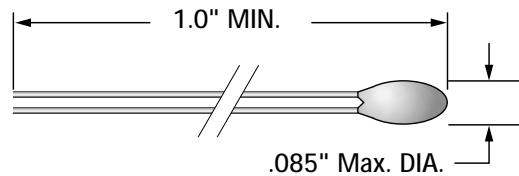
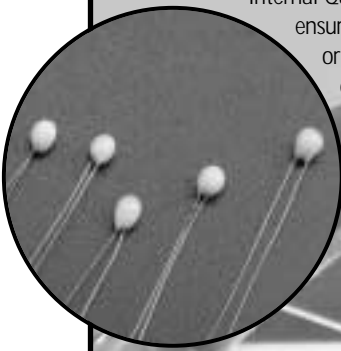

- A3 = +/- 1.0°C (0°C - 70°C)
- B3 = +/- 0.5°C (0°C - 70°C)
- C3 = +/- 0.2°C (0°C - 70°C)
- D3 = +/- 0.1°C (0°C - 70°C)

- K = +/- 10%
- J = +/- 5%
- G = +/- 2%
- F = +/- 1%

Device Features

- High Stability
- Interchangeable tolerances
- Hermetic, glass encapsulated bead
- Operating temperature range: -55°C to +300°C
- Meets or exceeds requirements of MIL-PRF-23648
- Dissipation Constant: .75 mW/°C in still air
- Thermal time response (In still air): 20 Seconds

Capabilities

- Quality Thermistor specializes in custom probe designs. Let QTI help you with your custom probe design using the QTGB thermistor element.

Standard Configurations

- #36 awg Platinum clad, Ni-Fe lead wires suitable for welding

Ordering Information

QTGB-14 D3

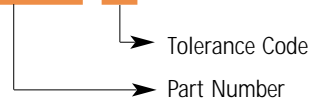

RESISTANCE @ 25°C (Ω)	PART NUMBER	R/T CURVE	ALPHA @25°C
5,000	QTGB-11	Z	-4.4%/C
10,000	QTGB-14	Z	-4.4%/C

Standard w/Insulated Leads

NTC thermistors with insulated leads provide a hassle free solution for potting into enclosures. Insulated leads can also provide a "built in" circuit board stand-off for air flow measurement.



Device Features

- Resistance values from 1,000 Ohms to 100 K Ohms
- Epoxy Coating
- Typical Dissipation Constant = 2mW/°C in still air
- Typical time constant in still air = 10 Seconds
- #28 AWG Kynar (Polyvinylidene Fluoride) insulated wire, silver plated solid copper conductor

Custom Configurations

Quality Thermistor offers one of the largest selections of Resistance vs. Temperature Curves in the industry. Many custom Resistance/Curve configurations are available. Other types of insulation material are also available. Contact Technical Support for your special requirements.

Standard Configuration

Specify (see below)

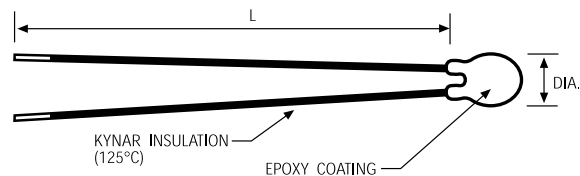

Ordering Information

QTMCA-14J

- Tolerance Code
- Lead Type
- Part Number

Lead Options:

- A = #28 AWG Kynar 2" Long
- B = #28 AWG Kynar 6" Long
- C = #28 AWG Kynar 12" Long



RESISTANCE @ 25°C (OHMS)	PART NUMBER	R-T CURVE	ALPHA (α)	BEAD DIA. (IN)
1,000	QTMC__-2	Z	(-4.4%)	.125
2,252	QTMC__-7	Z	(-4.4%)	.100
3,000	QTMC__-9	Z	(-4.4%)	.100
5,000	QTMC__-11	Z	(-4.4%)	.100
10,000	QTMC__-82	S	(-4.0%)	.100
10,000	QTMC__-14	Z	(-4.4%)	.100
20,000	QTMC__-19	Z	(-4.4%)	.100
100,000	QTMC__-43	V	(-4.9%)	.100
100,000	QTMC__-88	W	(-4.7%)	.100

NTC Leaded Thermistors

Miniature Interchangeable w/Insulated Leads

Quality Thermistor's miniature NTC thermistors feature a small .038" bead diameter providing an extremely fast thermal time response.

The QTMB Mini Bead NTC Thermistor is an extension of the QTInterchangeable series for applications that require interchangeability in a smaller size. The small .038" bead diameter provides an extremely fast thermal time response. Standard 6" long #34 AWG insulated leads enable direct placement into probe housings or remote temperature sensing where space is limited.



Device Features

- Lead Wire: #34 AWG Poly-Nylon insulated bifilar
- Typical Dissipation Constant 1 mw/C
- Typical thermal time response (In still air): 1 Second
- Epoxy Coating
- Temperature Range: -55°C to +125°C

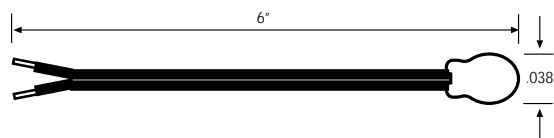

Ordering Information

QTMB-14A3



Tolerance:

- A3 = +/- 1C (0C-70C)
- B3 = +/- .5C (0C-70C)
- C3 = +/- .2C (0C-70C)

RESISTANCE @ 25°C (OHMS)	PART NUMBER	R-T CURVE	LEAD DIA.	BEAD DIA. (IN)
10,000	QTMB-14	Z	.0062	.038
15,000	QTMB-16	Z	.0062	.038

Interchangeable

The QTI interchangeable thermistor offers industry standard 3" long, #32 Awg. (.0075") bare leads.

QTI's Industry Standard Curve-Tracker

The designation name "interchangeable" is given to thermistors which have ultra-tight tolerances guaranteed to track a specific resistance-temperature curve.



Standard Configuration

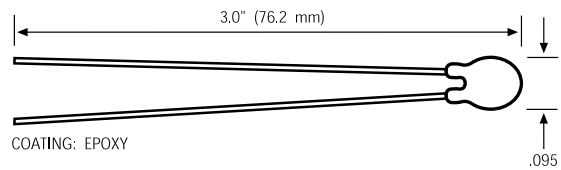

Ordering Information

QTLC-14C3

- Curve Tracking Code Suffix
- Part Number

Curve Tracking:

- D3 = +/- .1°C (0°C-70°C)
- C3 = +/- .2°C (0°C-70°C)
- B3 = +/- .5°C (0°C-70°C)
- A3 = +/- 1°C (0°C-70°C)



RESISTANCE @ 25°C (OHMS)	PART NUMBER	R-T CURVE	BEAD DIA. (IN)	COATING
2,252	QTLC-7	Z	.095	EPOXY
5,000	QTLC-11	Z	.095	EPOXY
10,000	QTLC-14	Z	.095	EPOXY
10,000	QTLC-82	S	.095	EPOXY
100,000	QTLC-88	W	.095	EPOXY

NTC Leaded Thermistors

Interchangeable w/Insulated Leads

The QTI interchangeable thermistor with insulated leads is a proven design for precision temperature measurement.

QTI's Industry Standard Curve-Tracker

The designation name "interchangeable" is given to thermistors which have ultra-tight tolerances guaranteed to track a specific resistance-temperature curve.

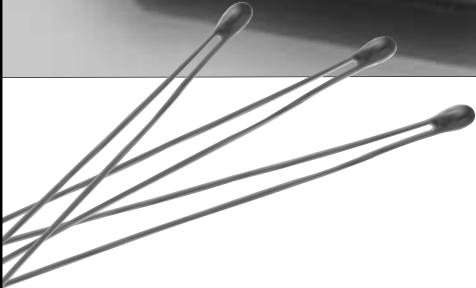

Standard Configuration

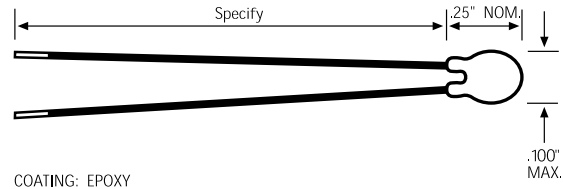

COATING: EPOXY

Ordering Information

QTLC A-14C3

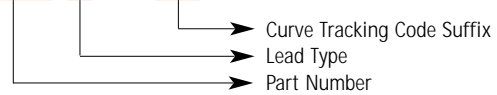

Lead Options:

- A = #28 AWG Kynar 2" Long
- B = #28 AWG Kynar 6" Long
- C = #28 AWG Kynar 12" Long

Curve Tracking:

- D3 = +/- .1°C (0°C-70°C)
- C3 = +/- .2°C (0°C-70°C)
- B3 = +/- .5°C (0°C-70°C)
- A3 = +/- 1°C (0°C-70°C)



RESISTANCE @ 25°C (OHMS)	PART NUMBER	R-T CURVE	LEAD DIA.	BEAD DIA. (IN)	COATING
2,252	QTLC__-7	Z	.013"	.100	EPOXY
5,000	QTLC__-11	Z	.013"	.100	EPOXY
10,000	QTLC__-14	Z	.013"	.100	EPOXY
10,000	QTLC__-82	S	.013"	.100	EPOXY
100,000	QTLC__-88	W	.013"	.100	EPOXY

QTHT Series

Quality Thermistor's High Temp Thermistors are ideal where measurements must be made at elevated temperatures.

Constructed with materials designed for high temperature operation, they have exceptional time response and durability at elevated temperatures.

- Competitively priced to glass bead thermistors
- More rugged construction vs. glass beads
- Leads can be soldered or welded
- 200°C continuous, 250°C intermittent use
- Higher TCRs @ temperature vs. glass beads
- Resistance toleranced at 150°C



Engineering Specifications

Dimensions:	L = 2"; Bead Dia. = .095" max.
Coating:	Epoxy
Lead Material:	Insulated solderable/weldable alloy
Dissipation Constant:	2.0 mW/°C min. – Still Air
Time Constant:	8 seconds max. - Still Air
Operating Temp:	200°C continuous 250°C intermittent

Typical Applications

- Electric Motor Over-Temp Protection
- High-Speed Laser Printers
- Automotive Applications
- Food and Consumer Products Industry

Contact QTI for other values and curves not shown.

Standard Configuration

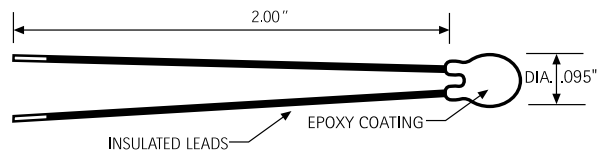

Ordering Information

Resistance @ 150°C (+/-10%)	Part Number	R-T Curve
10,000 Ω	QTHT-1	P
30,000 Ω	QTHT-2	R

Resistance Vs. Temperature	QTHT-1		QTHT-2	
	TEMP (C)	RESISTANCE (OHMS)	TOLERANCE (%)	RESISTANCE (OHMS)
100	53502.6	14.20	209062.83	15.50
105	44583.4	13.80	164254.86	14.95
110	37236.2	13.30	131390.20	14.40
115	31190.9	12.80	106581.74	13.80
120	26215.2	12.40	87397.59	13.20
125	22113.8	12.00	72264.82	12.60
130	18725.5	11.50	60134.37	12.00
135	15917.4	11.00	50285.94	11.48
140	13582.5	10.70	42211.00	11.00
145	11633.5	10.35	35540.58	10.51
150	10000.0	10.00	30000.00	10.00
155	8625.2	10.45	25379.64	10.55
160	7463.2	10.85	21515.97	11.16
165	6477.0	11.30	18278.95	11.68
170	5636.3	11.80	15563.45	12.25
175	4916.8	12.40	13283.48	12.83
180	4298.6	13.10	11367.97	13.41
185	3765.5	13.90	9757.82	14.00
190	3304.1	14.80	8403.17	14.59
195	2903.4	15.80	7264.30	15.19
200	2554.3	16.90	6305.00	15.79

NTC Surface Mount Thermistors

QT0805 Series

Quality Thermistor's QT0805 Surface Mount Thermistors are the ideal solution for temperature sensing functions found in temperature compensation networks.

The patented design features Leach Guard™ terminations which are able to withstand many of today's modern automated assembly and soldering processes. Standard EIA sizing allows for tape and reel packaging designed for automated placement equipment. Contact Technical Support for information regarding our SMD engineering kit.

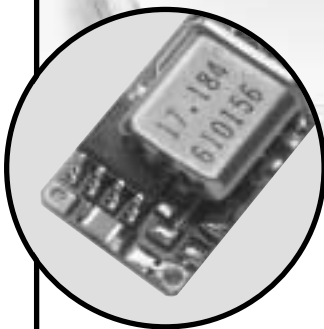

Typical installation in TCXO (temperature compensated crystal oscillator) application

Engineering Information

Thermal Time Constant:* 8 seconds (max.) - Still Air
 Dissipation Constant:* 2 mW/°C (min.) - Still Air
 Temperature Range: -65°C - 150°C
 Power Rating: 1/8 w (max.)

* Depends on mounting

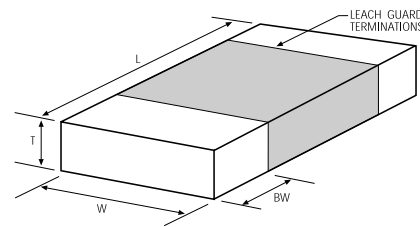

Dimensions QT0805 Style

L = .078" +/- .008"
 W = .049" +/- .008"
 T = .055" Max
 BW = .016" +/- .010"

PATENT #5,257,003

Ordering Information

QT0805Z-104K-?

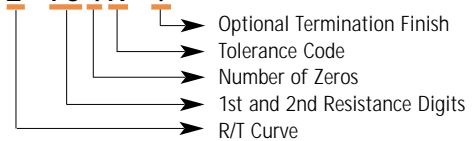

Tolerance Options:

M +/- 20%
 K +/- 10%
 J +/- 5%

Other sizes and values available. Contact factory for details.

-Optional Termination Finishes*:

T = Pure Tin
 G = Gold

-Standard Termination Finishes: Solder Tin/Lead (not RoHS compliant)



*Optional Termination Finishes are RoHS compliant

PART NUMBER	RESISTANCE @ 25°C (OHMS)	R-T CURVE	BETA (B) 75/25
QT0805K-500	50	K	2282
QT0805K-101	100	K	2282
QT0805X-102	1,000	X	3000
QT0805T-202	2,000	T	3181
QT0805Y-502	5,000	Y	3513
QT0805Y-103	10,000	Y	3513
QT0805Y-203	20,000	Y	3513
QT0805Z-503	50,000	Z	3966
QT0805Z-104	100,000	Z	3966
QT0805P-685	6.8 Meg	P	4829
QT0805P-106	10 Meg	P	4829

QT0603 Series

Quality Thermistor's 0603 Surface Mount Thermistors are the ideal solution where temperature sensing within a constrained area is needed.

The miniature 0603 footprint allows for placement in restrictive areas such as underneath crystal components in oscillator circuits. Manufactured with our patented Leach Guard™ termination process, they are designed to withstand most of today's automated soldering processes. Standard 0603 packaging allows for tape and reel packaging.



Engineering Information

Thermal Time Constant*: 5 sec. (max.) – Still Air
 Dissipation Constant*: 2mW/°C (min.) – Still Air
 Power Rating: 1/16W @ 25°C
 Temperature Range: -65°C to 150°C

* Depends on mounting

Design Features

- High density ceramic
- Passivated outer shell provides a protective coating and added stability
- Patented Leach-Guard™ termination process
- Precious metal conductor provides high electrical conductivity
- Nickel barrier to protect against leaching
- Tin-lead finish to meet industry solderability requirements

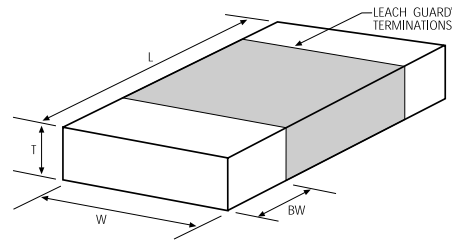

Dimensions

L = .063" +/- .004"
 W = .031" +/- .004"
 T = .020" Max
 BW = .008" +/- .004"

Ordering Information

QT0603Z-104K-?

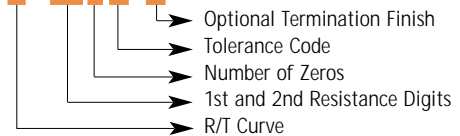

Tolerance Options:

M +/- 20%
 K +/- 10%
 J +/- 5%

Other sizes and values available. Contact factory for details.

-Optional Termination Finishes*:

T = Pure Tin
 G = Gold

-Standard Termination Finishes: Solder Tin/Lead (not RoHS compliant)



*Optional Termination Finishes are RoHS compliant

PART NUMBER	PACKAGE STYLE	RESISTANCE @ 25°C	R-T CURVE	BETA (β) 75/25
QT0603Y-203	0603	20,000Ω	Y	3513
QT0603Z-104	0603	100,000Ω	Z	3966

NTC Surface Mount Chip Thermistors

QTC11 (NTC) Series

The QTC11 NTC chip thermistors are designed for die attach and wire-bonding requirements found in today's hybrid microelectronics circuits. The QTC11 series is offered in a gold or silver termination finish for high-reliability conductive epoxy/wire bonded attachment.

Applications may include localized temperature sensing, temperature compensation, protection, and frequency control for sensitive communications systems and infrared sensing equipment.

The QTC11 Series is available for applications requiring narrow band, temperature point matching control and is also available in a military grade DSCC (Defense Supply Center Columbus) version. Contact Quality Thermistor's Applications Engineering Department for details.

Quality Thermistor, Inc. is
AS9100 certified

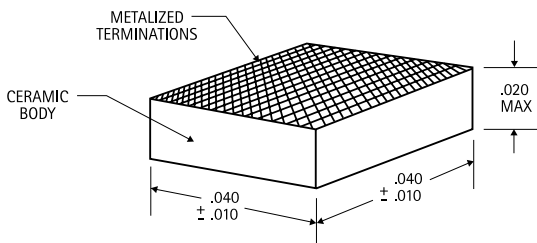

Dimensions QTC11 NTC STYLE

L = .040" +/- .010"
W = .040" +/- .010"
T = .020" Max

Tolerance Code:

K = 10%
J = 5%
G = 2%
F = 1%



Engineering Information

Thermal Time Constant*: 10 seconds maximum in still air

Dissipation Constant*: .625mW/C minimum

Power Rating: .0625W, derate to 0 at 125 (See Table 2)

Resistance At 25°C: 100 Ohm to 20 Mohm (See Table 1).

*Thermal Time and Dissipation Constant may vary depending on mounting.

TABLE 1

PART NUMBER	RESISTANCE @25C (Ohms)	ALPHA @ 25C
QTC11X -101J	100	-3.1%
-201J	200	-3.1%
-301J	300	-3.1%
-501J	500	-3.1%
QTC11Y -102J	1K	-3.9%
-202J	2K	-3.9%
-302J	3K	-3.9%
QTC11Z -502J	5K	-4.4%
-103J	10K	-4.4%
-203J	20K	-4.4%
-303J	30K	-4.4%
QTC11S -103J	10K	-4.0%
QTC11W -503J	50K	-4.7%
QTC11V -104J	100K	-4.9%
-204J	200K	-4.9%
QTC11P -504J	500K	-5.3%
-105J	1M	-5.3%
-205J	2M	-5.3%
QTC11R -106J	10M	-6.2%
-206J	20M	-6.2%

Contact Quality Thermistor for resistance values not listed above.

TABLE 2 Derating Curve for High Ambient Temperatures

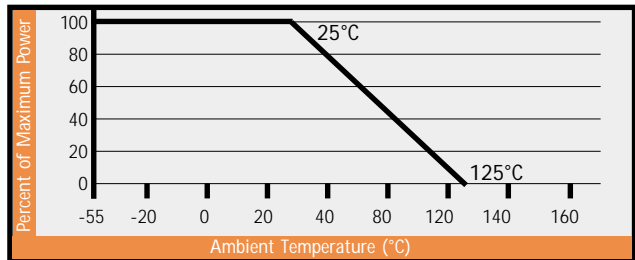

Ordering Information

QTC11 Z G-10 3 J

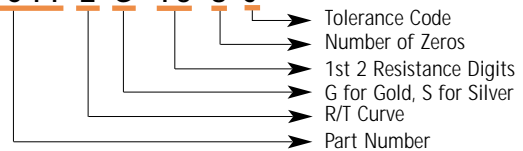

Military Grade Leaded Thermistors

These high-rel thermistors are suitable for critical applications in temperature measurement, temperature control, amplifier stabilization, power control, microprocessor interfacing, and numerous other applications. As the industry leader in Mil-Spec devices, we have a part to fill any need.



Style RTH06 MIL-PRF-23648/1 Qualified

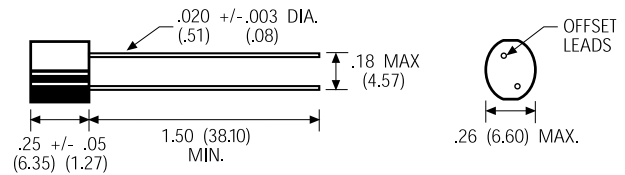

Note: Dimension in inches, (millimeters in parentheses)

Style RTH44 MIL-PRF-23648/20 Qualified

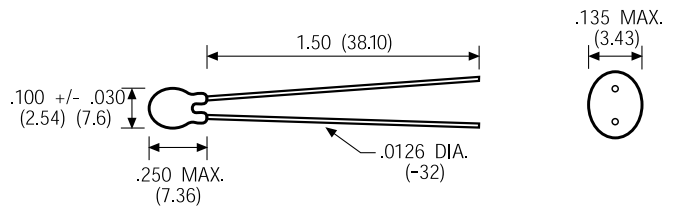

TABLE 1 Derating Curve for High Ambient Temperatures

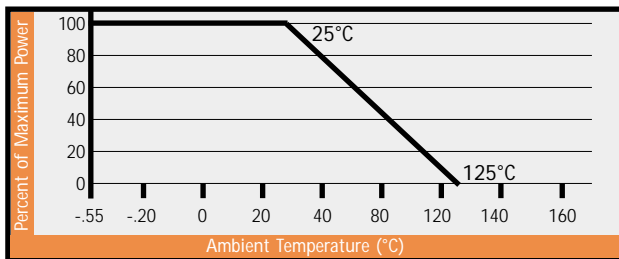

TABLE 2 Available Ratios and Part Values

STYLE	RESISTANCE (OHMS) RANGE AVAILABLE MIN-MAX	RESISTANCE RATIO	DISSIPATION CONSTANT	THERMAL TIME CONSTANT MAX. SECONDS	POWER RATING @ 25C (derating per Table 1)	MIL-PRF-23648 RESISTANCE RATIO R(25C)/R(125C)
RTH06	68-560	A	5mW/C	80	0.5 Watts	19.8
	680-4700	B	5mW/C	80	0.5 Watts	29.4
	7.5K-75K	C	5mW/C	80	0.5 Watts	48.7
RTH44	300-3000	A	2mW/C	25	0.2 Watts	19.8
	1000-10K	B	2mW/C	25	0.2 Watts	29.4
	30K-500K	C	2mW/C	25	0.2 Watts	48.7

TABLE 3 Resistance Temperature Characteristics Multipliers

TEMPERATURE (°C)	RATIO 19.8 (A)	RATIO 29.4 (B)	RATIO 48.7 (C)
-55	54.790	100.00	-
-15	5.770	7.380	8.800
0	2.850	3.270	3.660
25	1.000	1.000	1.000
50	.405	.360	.3200
75	.184	.148	.1160
100	.0923	.0675	.0470
125	.0503	.0340	.0205

Ordering Information

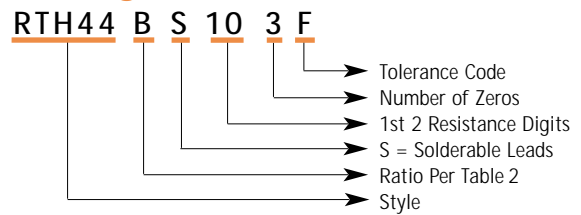

Tolerance Options:

K = 10% J = 5% G = 2% F = 1%

NTC Military Grade Thermistors

Military Grade Chip Thermistors

Screened, high-rel surface mount NTC thermistors are provided in the EIA 0805 package. Resistance values are specified at 25°C with resistances at other temperatures calculated using the appropriate resistance vs. temperature tables.

The data provided on this page outlines the DSCC (Defense Supply Center, Columbus) drawing MIL-PRF-32192. The complete specifications can be obtained by contacting DSCC (Defense Supply Center, Columbus). Please contact Quality Thermistor Inc., for devices provided to the MIL-PRF-32192 (1206 package) specification.

Engineering Information

- Thermal Time Constant*: 8 seconds maximum.
- Dissipation Constant*: 2mW/°C min.
- Power Rating: The thermistor shall be capable of dissipating a maximum power of .125 watt at 25°C. Thermistors shall be derated in accordance with Table 1.
- Resistance At 25°C: Zero power resistance values at 25°C (See Table 2).

*Thermal Time and Dissipation Constant may vary depending on mounting.

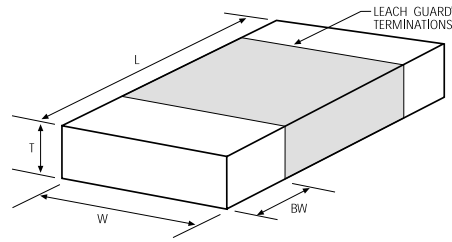

Dimensions MIL-PRF-32192/4 NTC STYLE

- L = .078" +/- .008"
- W = .049" +/- .008"
- T = .055" Max
- BW = .020" +/- .005"

Ordering Information

M32192 A 4 B 100 2 J M

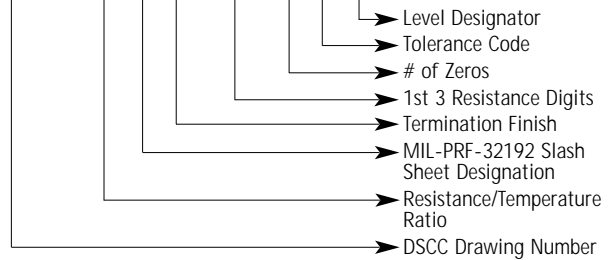

TABLE 3 Termination Materials

TYPE	MATERIAL	CODE
Solderable	Base metalization barrier metal, solder coated	B
Epoxy Bondable	Gold	G
Epoxy Bondable	Platinum Gold	U
Epoxy Bondable	Platinum Gold	T
Epoxy Bondable	Palladium Silver or Platinum Silver	C
Epoxy Bondable	Palladium Silver or Platinum Silver	D
Wire Bondable	Silver	S
Wire Bondable	Gold	W

TABLE 1 Derating Curve for High Ambient Temperatures

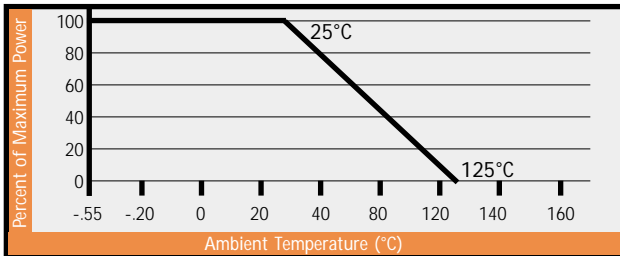

TABLE 2 25°C to 125°C Ratio

RATIO D (7.1)	RATIO H (13.0)	RATIO L (16.1)	RATIO A (19.8)	RATIO B (29.4)	RATIO M (23.3)	RATIO N (38.5)	RATIO C (48.7)	RATIO R (62.5)
47 Ohm to 250 Ohm	470 Ohm to 1.5K Ohm	2K Ohm to 4.7K Ohm	5K Ohm to 20K Ohm	47K Ohm to 100K Ohm	100K Ohm to 200K Ohm	240K Ohm to 510K Ohm	750K Ohm to 2M Ohm	4.7M Ohm to 10M Ohm

Military Grade Chip Thermistors

The High-Rel Negative Temperature Coefficient chip thermistor is designed for wire bonding applications found in hybrid circuitry. The "Top-Bottom" electrodes are available in silver or gold and accommodate most industry standard attachment methods.

Dsc (Defense Supply Center, Columbus) issued specification MIL-PRF-32192 which dictates the performance and inspection requirements for these devices which includes a test for wire bonding integrity. Several base resistance and curve combinations are available to suite a wide range of temperature compensation applications.

Quality Thermistor, Inc. is
AS9100 certified

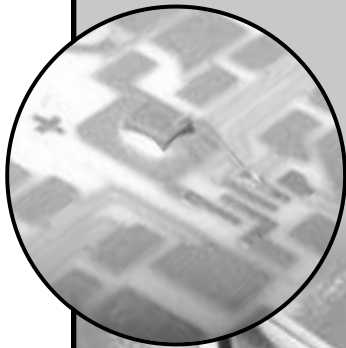

Engineering Information

Thermal Time Constant*: 10 seconds maximum in still air
 Dissipation Constant*: .625mW/C minimum
 Power Rating: .0625W, derate to 0 at 125
 Resistance At 25°C: 15 ohm to 20 Mohm (See Table 2).

*Thermal Time and Dissipation Constant may vary depending on mounting.

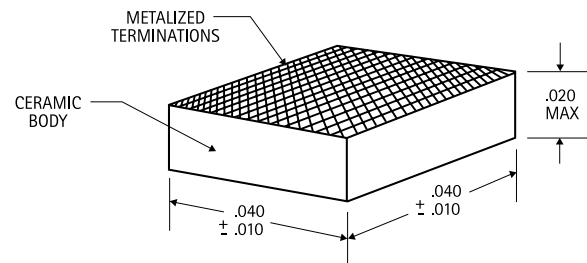

Dimensions MIL-PRF-32192/3 NTC STYLE

L = .040" +/- .010"
 W = .040" +/- .010"
 T = .020" Max

Ordering Information

M32192 M 3 W 100 2 J M

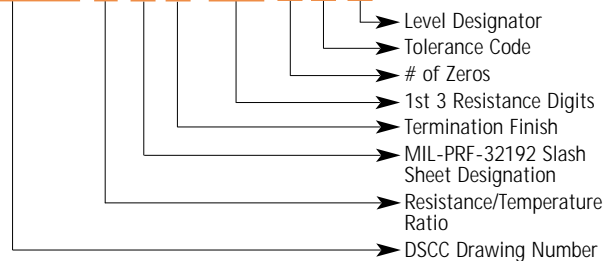

TABLE 1 Derating Curve for High Ambient Temperatures

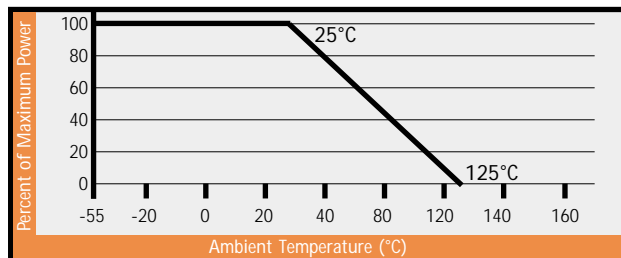

TABLE 3 Termination Materials

TYPE	MATERIAL	CODE
Epoxy Bondable	Gold	G
Epoxy Bondable	Platinum Gold	U
Epoxy Bondable	Platinum Gold	T
Epoxy Bondable	Palladium Silver or Platinum Silver	C
Epoxy Bondable	Palladium Silver or Platinum Silver	D
Wire Bondable	Silver	S
Wire Bondable	Gold	W

TABLE 2

RATIO D (7.1)	RATIO H (13.0)	RATIO L (16.1)	RATIO A (19.8)	RATIO B (29.4)	RATIO M (23.3)	RATIO N (38.5)	RATIO C (48.7)	RATIO R (62.5)	RATIO X (142.9)
15 Ohm to 25 Ohm	100 Ohm to 500 Ohm	200 Ohm to 500 Ohm	1K Ohm to 3.3K Ohm	3.3K Ohm to 10K Ohm	10K Ohm to 30K Ohm	30K Ohm to 100K Ohm	75K Ohm to 300K Ohm	500K Ohm to 2M Ohm	6.8M Ohm to 20M Ohm

R/T Characteristics of NTC Thermistors

CURVE Z				CURVE Y				CURVE T				CURVE W			
-4.4%/°C @ 25°C				-3.9%/°C @ 25°C				-3.5%/°C @ 25°C				-4.7%/°C @ 25°C			
TEMP (°C)	RT/R25	MAX DEV	NTC	TEMP (°C)	RT/R25	MAX DEV	NTC	TEMP (°C)	RT/R25	MAX DEV	NTC	TEMP (°C)	RT/R25	MAX DEV	NTC
-55	96.40000	3.80	7.400	-55	54.78000	8.90	6.500	-55	36.60000	20.90	5.800	-55	117.50000	4.30	7.400
-50	67.06000	3.50	7.200	-50	40.06000	8.20	6.100	-50	27.50000	18.50	5.500	-50	81.32000	3.60	7.100
-45	47.08421	3.25	6.961	-45	29.53146	7.49	5.909	-45	20.90389	16.77	5.374	-45	56.69045	3.22	6.918
-40	33.66000	3.00	6.700	-40	22.05000	6.80	5.800	-40	16.10000	15.40	5.300	-40	40.16000	3.00	6.800
-35	24.28525	2.70	6.442	-35	16.59240	6.18	5.613	-35	12.46138	13.95	5.130	-35	28.66344	2.71	6.666
-30	17.70000	2.40	6.200	-30	12.58000	5.60	5.400	-30	9.70000	12.50	4.900	-30	20.64000	2.40	6.500
-25	13.03128	2.16	5.984	-25	9.61546	5.01	5.238	-25	7.61934	11.18	4.682	-25	14.99955	2.15	6.304
-20	9.71200	1.90	5.800	-20	7.42200	4.40	5.100	-20	6.05000	9.90	4.500	-20	11.03000	1.90	6.100
-15	7.29800	1.60	5.650	-15	5.77700	3.80	4.950	-15	4.84000	8.60	4.350	-15	8.17500	1.60	5.900
-10	5.53400	1.40	5.500	-10	4.52700	3.30	4.800	-10	3.89000	7.40	4.200	-10	6.11900	1.40	5.700
-5	4.23400	1.20	5.300	-5	3.58000	2.80	4.650	-5	3.15000	6.20	4.100	-5	4.61500	1.20	5.550
0	3.26600	1.00	5.100	0	2.84800	2.30	4.500	0	2.57000	5.00	4.000	0	3.51000	1.00	5.400
5	2.54000	0.75	4.950	5	2.28200	1.70	4.350	5	2.10000	3.90	3.900	5	2.69000	0.75	5.250
10	1.99000	0.50	4.800	10	1.83800	1.20	4.200	10	1.73000	2.70	3.800	10	2.07800	0.50	5.100
15	1.57100	0.30	4.650	15	1.49200	0.70	4.100	15	1.43000	1.60	3.700	15	1.61700	0.30	4.950
20	1.24900	0.10	4.500	20	1.21800	0.30	4.000	20	1.19000	0.50	3.600	20	1.26700	0.10	4.800
25	1.00000	0.00	4.400	25	1.00000	0.00	3.900	25	1.00000	0.00	3.500	25	1.00000	0.00	4.700
30	0.80580	0.20	4.300	30	0.82610	0.60	3.800	30	0.84100	1.40	3.400	30	0.79420	0.20	4.600
35	0.65320	0.40	4.150	35	0.68620	1.00	3.700	35	0.71100	2.30	3.300	35	0.63480	0.40	4.450
40	0.53260	0.60	4.000	40	0.57270	1.40	3.600	40	0.60400	3.20	3.200	40	0.51050	0.60	4.300
45	0.43680	0.80	3.900	45	0.48040	1.80	3.500	45	0.51500	4.10	3.150	45	0.41290	0.80	4.200
50	0.36020	1.00	3.800	50	0.40450	2.20	3.400	50	0.44200	5.00	3.100	50	0.33590	1.00	4.100
55	0.29860	1.10	3.700	55	0.34270	2.60	3.300	55	0.38000	5.90	3.000	55	0.27480	1.10	4.000
60	0.24880	1.20	3.600	60	0.29140	3.00	3.200	60	0.32800	6.70	2.900	60	0.22950	1.20	3.900
65	0.20820	1.40	3.500	65	0.24900	3.30	3.100	65	0.28500	7.50	2.850	65	0.18670	1.40	3.800
70	0.17510	1.60	3.400	70	0.21370	3.60	3.000	70	0.24800	8.20	2.800	70	0.15500	1.60	3.700
75	0.14800	1.75	3.350	75	0.18410	4.00	2.900	75	0.21600	9.00	2.700	75	0.12930	1.75	3.600
80	0.12560	1.90	3.300	80	0.15920	4.30	2.800	80	0.18900	9.80	2.600	80	0.10840	1.90	3.500
85	0.10710	2.00	3.200	85	0.13820	4.60	2.750	85	0.16700	10.50	2.550	85	0.09120	2.00	3.400
90	0.09164	2.10	3.100	90	0.12040	4.90	2.700	90	0.14700	11.20	2.500	90	0.07710	2.10	3.300
95	0.07874	2.25	3.000	95	0.10530	4.20	2.600	95	0.13000	11.90	2.400	95	0.06540	2.25	3.250
100	0.06792	2.40	2.900	100	0.09230	5.50	2.500	100	0.11500	12.60	2.350	100	0.05570	2.40	3.200
105	0.05880	2.50	2.850	105	0.08130	5.80	2.450	105	0.10173	13.40	2.300	105	0.04760	2.50	3.100
110	0.05108	2.60	2.800	110	0.07180	6.10	2.400	110	0.08996	14.20	2.250	110	0.04080	2.60	3.000
115	0.04452	2.75	2.750	115	0.06360	6.40	2.350	115	0.07949	15.10	2.200	115	0.03510	2.75	2.950
120	0.03894	2.90	2.700	120	0.05650	6.70	2.300	120	0.07076	16.00	2.150	120	0.03030	2.90	2.900
125	0.03416	3.00	2.600	125	0.05040	6.90	2.250	125	0.06183	16.90	2.100	125	0.02630	3.00	2.850
130	0.03006	3.10	2.500	130	0.04514	7.30	2.200	130	0.05436	17.90	2.050	130	0.02280	3.10	2.800
135	0.02653	3.25	2.440	135	0.04057	7.58	2.176	135	0.04772	18.55	2.020	135	0.01982	3.25	2.750
140	0.02348	3.40	2.400	140	0.03660	7.80	2.150	140	0.04161	19.00	2.000	140	0.01730	3.40	2.700
145	0.02084	3.47	2.353	145	0.03314	8.11	2.087	145	0.03608	19.52	1.977	145	0.01516	3.47	2.650
150	0.01854	3.50	2.300	150	0.03010	8.50	2.000	150	0.03119	20.10	1.950	150	0.01330	3.50	2.600

NTC

The NTC column above indicates the slope at discrete points on the Resistance vs. Temperature response curve for each formulation offered by Quality Thermistor. The rate is expressed in the percentage of resistance value change per degree Celsius. For example: The response curve of a 10,000 ohm, Curve Z thermistor exhibits a slope of -4.4%/C at 25°C.

The NTC column can also be used to determine the temperature tolerance of a thermistor which has its tolerance expressed by a percentage. Since each unit of NTC change equates to one degree Celsius, one can use the NTC value to determine temperature tolerance at any given temperature. For example: a 10,000-ohm,

Curve Z thermistor with a resistance tolerance of +/-5% at 25°C will have a temperature tolerance of +/- 1.136°C (divide 5% part tolerance by the NTC value at 25°C of 4.4 equals 1.136).

MAX DEV

The MAX DEV column above represents the manufacturing tolerance of each NTC curve at each corresponding temperature above the advertised tolerance of the part number. For example: a Curve Z thermistor which has an advertised tolerance of +/-5% at 25°C will have a maximum deviation of 0.00% added to the specified part tolerance at 25°C to yield overall part tolerance of +/-5%. The same +/-5%, 10,000 ohm Curve Z thermistor would be a +/-6.6% part at 70°C as the 5% part tolerance would be added to the 1.6% MAX DEV value to yield +/-6.6%.

R/T Characteristics of NTC Thermistors

CURVE V				CURVE M				CURVE P				CURVE R			
-4.9%/°C @ 25°C				-4.2%/°C @ 25°C				-5.3%/°C @ 25°C				-6.2%/°C @ 25°C			
TEMP (°C)	RT/R25	MAX DEV	NTC	TEMP (°C)	RT/R25	MAX DEV	NTC	TEMP (°C)	RT/R25	MAX DEV	NTC	TEMP (°C)	RT/R25	MAX DEV	NTC
-55	130.60000	6.30	7.500	-55	79.42000	3.90	7.200	-55	159.00000	25.00	7.600	-55	479.00000	26.90	9.500
-50	90.06000	5.00	7.200	-50	56.49000	3.50	6.900	-50	110.10000	17.40	7.400	-50	307.00000	24.10	9.300
-45	62.48621	4.48	7.074	-45	40.51113	3.23	6.588	-45	77.39160	16.11	7.281	-45	196.70413	22.81	9.101
-40	44.03000	4.20	7.000	-40	29.49000	3.00	6.300	-40	55.50000	15.60	7.200	-40	128.00000	22.30	8.900
-35	31.23701	3.54	6.829	-35	21.64354	2.71	6.074	-35	39.76689	15.35	7.100	-35	83.16064	21.54	8.695
-30	22.35000	2.90	6.600	-30	16.03000	2.40	5.900	-30	28.40000	14.60	7.000	-30	54.00000	20.60	8.500
-25	16.14073	2.74	6.384	-25	11.97596	2.14	5.755	-25	20.34709	14.19	6.920	-25	35.20122	19.71	8.320
-20	11.80000	2.70	6.200	-20	9.04000	1.90	5.600	-20	14.65000	13.70	6.800	-20	23.38000	18.50	8.100
-15	8.69100	2.40	6.050	-15	6.87300	1.65	5.400	-15	10.51000	12.70	6.600	-15	15.84000	16.80	7.800
-10	6.45300	2.10	5.900	-10	5.26700	1.40	5.200	-10	7.60900	11.70	6.400	-10	10.85000	15.40	7.500
-5	4.83000	1.80	5.700	-5	4.07000	1.20	5.100	-5	5.55800	10.50	6.200	-5	7.50800	14.30	7.300
0	3.64300	1.40	5.500	0	3.16600	1.00	4.900	0	4.09400	9.90	6.000	0	5.24600	13.20	7.100
5	2.77400	1.20	5.350	5	2.48100	0.75	4.800	5	3.04100	9.10	5.850	5	3.70000	12.05	6.900
10	2.12800	0.90	5.200	10	1.95800	0.50	4.700	10	2.27700	8.20	5.700	10	2.63300	10.90	6.700
15	1.64400	0.50	5.100	15	1.55600	0.30	4.550	15	1.71800	7.40	5.550	15	1.89100	9.80	6.550
20	1.27800	0.20	5.000	20	1.24300	0.10	4.400	20	1.30600	6.60	5.400	20	1.36900	8.70	6.400
25	1.00000	0.00	4.900	25	1.00000	0.00	4.200	25	1.00000	5.90	5.250	25	1.00000	7.75	6.250
30	0.78700	0.40	4.700	30	0.80900	0.20	4.000	30	0.77090	5.20	5.100	30	0.73580	6.80	6.100
35	0.62340	0.65	4.600	35	0.65800	0.40	3.850	35	0.59830	4.40	5.000	35	0.54550	5.85	5.950
40	0.49680	0.90	4.500	40	0.53830	0.60	3.700	40	0.46740	3.70	4.900	40	0.40730	4.90	5.800
45	0.39830	1.20	4.350	45	0.44270	0.80	3.650	45	0.36470	2.90	4.750	45	0.30650	4.05	5.650
50	0.32100	1.50	4.250	50	0.36570	1.00	3.600	50	0.29050	2.40	4.600	50	0.23170	3.20	5.500
55	0.26020	1.70	4.150	55	0.30360	1.10	3.500	55	0.23110	1.80	4.500	55	0.17640	2.35	5.350
60	0.21200	1.90	4.050	60	0.25330	1.20	3.400	60	0.18480	1.10	4.400	60	0.13580	1.50	5.200
65	0.17340	2.15	4.000	65	0.21220	1.40	3.300	65	0.14870	0.65	4.300	65	0.10490	0.75	5.100
70	0.14260	2.40	3.900	70	0.17860	1.60	3.200	70	0.12020	0.00	4.200	70	0.08130	0.00	5.000
75	0.11790	2.55	3.800	75	0.15100	1.75	3.150	75	0.09770	0.50	4.100	75	0.06350	0.70	4.900
80	0.09780	2.70	3.700	80	0.12810	1.90	3.100	80	0.07980	1.00	4.000	80	0.04980	1.40	4.800
85	0.08140	2.95	3.600	85	0.10910	2.00	3.000	85	0.06550	1.50	3.900	85	0.03930	2.10	4.700
90	0.06810	3.20	3.500	90	0.09330	2.10	2.900	90	0.05400	2.10	3.800	90	0.03130	2.80	4.600
95	0.05721	3.40	3.450	95	0.08007	2.25	2.850	95	0.04470	2.60	3.700	95	0.02500	3.45	4.500
100	0.04820	3.60	3.400	100	0.06897	2.40	2.800	100	0.03720	3.10	3.600	100	0.02000	4.10	4.400
105	0.04080	3.80	3.300	105	0.05960	2.50	2.750	105	0.03119	3.50	3.550	105	0.01610	4.65	4.300
110	0.03470	4.00	3.200	110	0.05167	2.60	2.700	110	0.02618	4.00	3.500	110	0.01300	5.20	4.200
115	0.02960	4.20	3.150	115	0.04493	2.75	2.700	115	0.02200	4.50	3.400	115	0.01060	5.80	4.100
120	0.02530	4.40	3.100	120	0.03920	2.90	2.700	120	0.01860	4.90	3.300	120	0.00870	6.40	4.000
125	0.02170	4.50	3.000	125	0.03420	3.00	2.600	125	0.01580	5.30	3.200	125	0.00710	7.00	3.900
130	0.01870	4.70	3.000	130	0.03010	3.10	2.500	130	0.01340	5.80	3.200	130	0.00590	7.60	3.800
135	0.01616	4.86	2.967	135	0.02653	3.25	2.441	135	0.01142	6.23	3.173	135	0.00488	8.12	3.746
140	0.01400	5.00	2.900	140	0.02337	3.40	2.400	140	0.00980	6.60	3.100	140	0.00400	8.60	3.700
145	0.01217	5.18	2.844	145	0.02064	3.47	2.353	145	0.00846	6.95	3.005	145	0.00329	9.09	3.614
150	0.01060	5.40	2.800	150	0.01834	3.50	2.300	150	0.00730	7.30	2.900	150	0.00280	9.60	3.500

SURFACE MOUNT PARTS AVAILABLE IN THE FOLLOWING RESISTANCE RANGES PER CURVE

- Curve Z 10K, 30K - 100K
- Curve Y 5K - 20K
- Curve X 300 - 1,500
- Curve K 47 - 82
- Curve S 100K - 200K
- Curve T 2K - 4.9K
- Curve V 1M - 2M
- Curve W 500K
- Curve P 6.8M - 10M

RADIAL LEADED PARTS AVAILABLE IN THE FOLLOWING RANGES PER CURVE







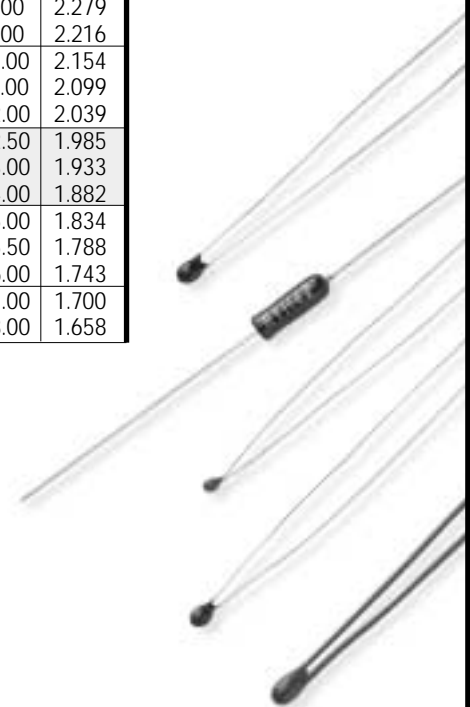

- Curve Z 1K - 20K
- Curve Y 100 - 2K
- Curve X 40 - 200
- Curve S 10K - 50K
- Curve V 20K - 200K
- Curve W 30K - 100K
- Curve P 100K - 1.2M
- Curve R 3.1M - 40M
- Curve P 20K - 150K

R/T Characteristics of NTC Thermistors

CURVE S				CURVE X				CURVE K			
-4.0%/°C @ 25°C				-3.1%/°C @ 25°C				-2.45%/°C @ 25°C			
TEMP (°C)	RT/R25	MAX DEV	NTC	TEMP (°C)	RT/R25	MAX DEV	NTC	TEMP (°C)	RT/R25	MAX DEV	NTC
-55	60.78000	5.00	6.500	-55	31.90000	21.60	6.400	-55	11.51000	28.00	4.174
-50	44.13000	3.90	6.000	-50	24.30000	18.50	5.600	-50	9.55000	23.00	4.020
-45	32.31143	3.45	5.950	-45	18.60825	16.63	5.144	-45	7.97015	20.25	3.875
-40	23.98000	3.30	5.900	-40	14.40000	15.40	4.900	-40	6.69000	19.00	3.739
-35	17.93125	2.98	5.806	-35	11.27489	14.00	4.675	-35	5.63699	18.00	3.608
-30	13.52000	2.60	5.600	-30	8.93000	12.50	4.500	-30	4.77000	17.00	3.483
-25	10.27869	2.33	5.369	-25	7.11471	11.15	4.431	-25	4.05689	16.01	3.365
-20	7.89100	2.10	5.200	-20	5.69000	9.90	4.400	-20	3.47000	15.00	3.256
-15	6.10200	1.80	5.100	-15	4.56000	8.65	4.350	-15	2.98000	14.00	3.153
-10	4.75400	1.50	4.900	-10	3.68000	7.40	4.300	-10	2.56000	13.00	3.043
-5	3.73100	1.30	4.800	-5	2.99000	6.20	4.100	-5	2.22000	11.00	2.956
0	2.94900	1.10	4.600	0	2.45000	5.00	3.900	0	1.93000	9.00	2.871
5	2.34600	0.90	4.500	5	2.02000	3.85	3.750	5	1.67800	8.50	2.774
10	1.87900	0.60	4.400	10	1.68000	2.70	3.600	10	1.47000	8.00	2.704
15	1.51300	0.40	4.300	15	1.42000	1.60	3.500	15	1.29000	5.00	2.635
20	1.22600	0.10	4.200	20	1.18000	0.50	3.400	20	1.13000	3.00	2.486
25	1.00000	0.00	4.000	25	1.00000	0.00	3.100	25	1.00000	0.00	2.450
30	0.81940	0.20	3.900	30	0.85400	1.40	3.000	30	0.88450	4.00	2.414
35	0.67520	0.40	3.800	35	0.73200	2.30	2.950	35	0.78470	6.00	2.346
40	0.55920	0.70	3.700	40	0.62800	3.20	2.900	40	0.69830	8.00	2.279
45	0.46550	0.90	3.600	45	0.53700	4.10	2.850	45	0.62320	9.00	2.216
50	0.38930	1.10	3.500	50	0.46400	5.00	2.800	50	0.55780	10.00	2.154
55	0.32700	1.20	3.450	55	0.40300	5.85	2.750	55	0.50000	11.00	2.099
60	0.27600	1.30	3.400	60	0.35000	6.70	2.700	60	0.45050	12.00	2.039
65	0.23390	1.50	3.300	65	0.30500	7.45	2.650	65	0.40640	12.50	1.985
70	0.19900	1.80	3.200	70	0.26700	8.20	2.600	70	0.36750	13.00	1.933
75	0.17000	2.00	3.100	75	0.23600	9.00	2.550	75	0.33320	14.00	1.882
80	0.14580	2.10	3.050	80	0.20800	9.80	2.500	80	0.30270	15.00	1.834
85	0.12550	2.20	3.000	85	0.18300	10.50	2.450	85	0.27570	15.50	1.788
90	0.10840	2.30	2.900	90	0.16300	11.20	2.400	90	0.25160	16.00	1.743
95	0.09393	2.50	2.800	95	0.14500	11.90	2.350	95	0.23010	17.00	1.700
100	0.08168	2.60	2.750	100	0.13000	12.60	2.300	100	0.21090	18.00	1.658
105	0.07126	2.70	2.700	105	0.11700	12.90	2.250				
110	0.06235	2.80	2.600	110	0.10500	13.20	2.200				
115	0.05473	3.00	2.550	115	0.09400	13.50	2.150				
120	0.04818	3.20	2.500	120	0.08500	14.25	2.100				
125	0.04253	3.30	2.450	125	0.07700	15.00	2.050				
130	0.03764	3.40	2.400	130	0.07000	15.75	2.000				
135	0.03340	3.54	2.363	135	0.06372	16.20	1.970				
140	0.02972	3.70	2.300	140	0.05800	16.50	1.950				
145	0.02652	3.85	2.171	145	0.05278	16.87	1.927				
150	0.02370	4.00	2.000	150	0.04800	17.30	1.900				

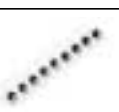

PTC THERMISTORS DIRECTORY

Product Image	Catalog Page	Description	Part Series	Available Tolerances	Mil-Spec Equivalent	Key Features	Typical Applications
	22	EIA standard package Surface Mount Thermistor	QT0805	1%, 2%, 5%, 10%	M32192/2	Linear 7,000 ppm/°C temperature coefficient	Board level temperature compensation
	23	Wire bondable hybrid package	QTC11	1%, 2%, 5%, 10%	M32192/1	High reliability, gold or silver terminations	Board level temperature compensation
	24	Hybrid mountable with 5-sided conductors	QTCH	1%, 2%, 5%, 10%	N/A	Reliable conductive epoxy mounting	Board level temperature compensation
	25	Axial Leaded, glass encapsulated D035 package	RTH42	5%, 10%		High-reliability, Military grade PTC thermistor MIL-PRF-23648/19	Temperature compensation, control and stabilization
	25	Axial Leaded, molded body	RTH22	5%, 10%		High-reliability, Military grade thermistor per MIL-PRF-23648/9	Temperature compensation, control and stabilization
	25	Axial Leaded, glass encapsulated	QTG12	1%, 2%, 5%, 10%	RTH42	Commercial grade of RTH42	Temperature compensation, control and stabilization
	25	Axial Leaded, molded body	QTM12	1%, 2%, 5%, 10%	RTH42	Commercial grade version of RTH22	Temperature compensation, control and stabilization
	26	Wire bondable hybrid package	32192/1	1%, 2%, 5%, 10%		High-reliability, Military grade PTC thermistor	Temperature compensation, control and stabilization
	27	0805 package, mil-spec PTC Surface Mount Thermistor	32192/2	1%, 2%, 5%, 10%		High-reliability, Military grade surface mount PTC thermistor	Board level temperature compensation

PTC Surface Mount Thermistors

QT0805 Series

QTTM brand PTC Surface Mount Thermistors exhibit a stable, proportional and linear resistance vs. temperature signal approximating 0.7% / °C.

The QT0805 is commonly designed into applications requiring precision, narrow band, temperature point matched control or broader temperature range circuit compensation. Consistent component geometry with Quality Thermistor's reliable, full wrap-around Leach Guard termination facilitates trouble-free, automated board placement. R25 °C values from 22 ohm through 36K ohm offer circuit design flexibility.

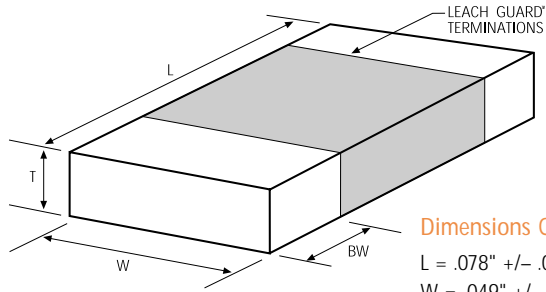

Dimensions QT0805 STYLE

L = .078" +/- .008"
 W = .049" +/- .008"
 T = .055" Max
 BW = .016" +/- .010"

Engineering Information

Positive Temperature Coefficient: .7%/C
 Operating Temperature Range: -55C to +100C
 Storage Temperature: -65C to +150C
 Thermal Time Constant: 30 Seconds max.-Still Air
 Dissipation Constant: 2.5 mW/C min.-Still Air
 Power Rating: 0.250 Watts @ 25C derated to 100C (Table 1)

TABLE 1 Power Derating Curve

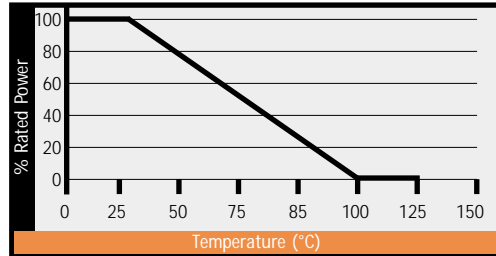

TABLE 2 Resistance Multipliers at Specified Temperature

TEMP. DEG. C	22-68 OHMS	82-150 OHMS	180-470 OHMS	560-1200 OHMS	1500-5600 OHMS	6800-36K OHMS
-55	.490	.500	.500	.500	.500	.490
-15	.790	.730	.730	.730	.730	.720
0	.845	.820	.820	.815	.835	.815
25	1.000	1.000	1.000	1.000	1.000	1.000
50	1.150	1.180	1.180	1.200	1.180	1.18
75	1.330	1.370	1.400	1.420	1.450	1.370
100	1.540	1.580	1.620	1.660	1.670	(1.650)

* Multipliers in parentheses must be characterized beyond 75C to 90C through calibration testing.

TABLE 3 Resistance Tolerances at Specified Temperatures

TEMP. DEG. C	F +/- %	G +/- %	J +/- %	K +/- %\
-55	15	17	20	25
-15	9	10	13	18
0	3	4	7	12
25	1	2	5	10
50	3	4	7	12
75	5	6	9	14
100	7	9	12	17

Ordering Information

QT0805 - 102K

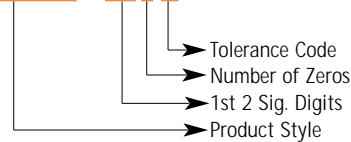

Tolerance Code:

K = 10% with Tin/Lead Terminations E = 10% with Gold Terminations
 J = 5% with Tin/Lead Terminations D = 5% with Gold Terminations
 G = 2% with Tin/Lead Terminations C = 2% with Gold Terminations
 F = 1% with Tin/Lead Terminations B = 1% with Gold Terminations

PTC Chip Thermistors

Standard PTC Thermistor Die

PTC Silicon Die thermistors are used in wire-bonding and specialized reflow-soldering applications.

Board attachment by either wire bonding, conductive epoxy, or a combination of both may be used. Solder attachment may be performed using different solder configurations, however, it is not recommended.



Standard Configuration

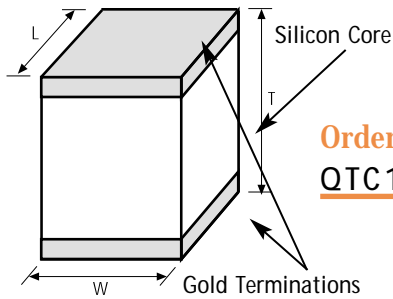

Ordering Information

QTC11-100K

Tolerance Code
Part Number

Tolerance:

K = 10% G = 2%
J = 5% F = 1%

TABLE 2 Derating Curve for High Ambient Temperatures

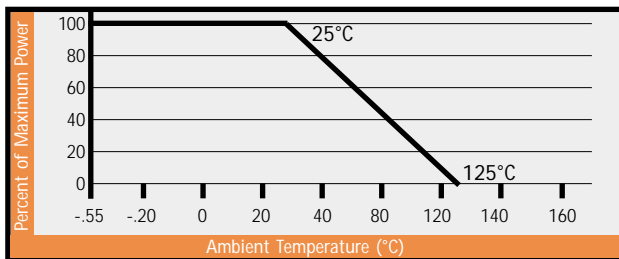

TABLE 3 Resistance Multipliers at Specified Temperature

TEMPERATURE	10 TO 68 OHMS	82 TO 150 OHMS	180 TO 470 OHMS	560 TO 1200 OHMS	1500 TO 5600 OHMS	6800 TO 10,000 OHMS
**(-55°C)	0.615	0.582	0.560	0.550	0.515	0.510
-15°C	0.790	0.770	0.755	0.740	0.730	0.730
0°C	0.863	0.847	0.838	0.835	0.825	0.825
25°C	1.000	1.000	1.000	1.000	1.000	1.000
50°C	1.160	1.170	1.180	1.200	1.230	1.190
75°C	1.350	1.370	1.400	1.420	1.450	1.400
100°C	1.545	1.584	1.623	1.656	1.670	1.610
** (125°C)	1.750	1.800	1.860	1.920	1.960	1.830

**Multipliers applicable to military grade only.

Engineering Information

*Dissipation Constant: See below
 *Thermal Time Constant: See below
 Resistance Coefficient: See PTC table 1
 Power Rating: 0.0625 watts @ 25°C
 derated to 125°C-See Table 1
 Operating Range: -55°C to 125°C

TABLE 1 Part Dimensions

RESISTANCE OHMS @ 25°C	PART NO.	L +/- .010	W +/- .010	T +/- .010	NOMINAL D.C.*	T.C.*
10	QTC11 -100	.032	.032	.028	2MW	8 sec.
12	-120	.032	.032	.028	2MW	8 sec.
15	-150	.032	.032	.050	2MW	8 sec.
18	-180	.032	.032	.050	2MW	8 sec.
22	-220	.032	.032	.050	2MW	8 sec.
27	-270	.032	.032	.050	2MW	8 sec.
33	-330	.0332	.032	.050	2MW	8 sec.
39	-390	.032	.032	.050	2MW	8 sec.
47	-470	.032	.032	.050	2MW	8 sec.
56	-560	.032	.032	.050	2MW	8 sec.
68	-680	.032	.032	.050	2MW	8 sec.
82	-820	.032	.032	.050	2MW	8 sec.
100	-101	.032	.032	.050	2MW	8 sec.
120	-121	.032	.032	.050	2MW	8 sec.
150	-151	.032	.032	.050	2MW	8 sec.
180	-181	.032	.032	.050	2MW	8 sec.
220	-221	.032	.032	.050	2MW	8 sec.
270	-271	.032	.032	.050	2MW	8 sec.
330	-331	.032	.032	.050	2MW	8 sec.
390	-391	.032	.032	.050	2MW	8 sec.
470	-471	.032	.032	.050	2MW	8 sec.
560	-561	.032	.032	.050	2MW	8 sec.
680	-681	.032	.032	.050	2MW	8 sec.
750	-751	.032	.032	.050	2MW	8 sec.
820	-821	.032	.032	.050	2MW	8 sec.
1000	-102	.032	.032	.050	2MW	8 sec.
1200	-122	.032	.032	.050	2MW	8 sec.
1500	-152	.032	.032	.050	2MW	8 sec.
1800	-182	.032	.032	.050	2MW	8 sec.
2200	-222	.038	.038	.072	2MW	8 sec.
2700	-272	.038	.038	.072	2MW	8 sec.
3300	-332	.038	.038	.072	2MW	8 sec.
3900	-392	.038	.038	.072	2MW	8 sec.
4700	-472	.038	.038	.072	2MW	8 sec.
5600	-562	.038	.038	.072	2MW	8 sec.
6800	-682	.038	.038	.072	2MW	8 sec.
8200	-822	.030	.030	.072	2MW	8 sec.
10000	-103	.022	.022	.072	2MW	8 sec.

*D.C. = Dissipation Constant MW/C

*T.C. = Time Constant Seconds in Free Air



PTC Chip Thermistors

Microelectronic Surface Mount PTC THERMISTORS

Microelectronic Surface Mount Thermistors

PTC Microelectronic SMTs are the solution where hybrid mounting is a must.

The 5-sided wrap-around terminations allow reliable mounting using conventional conductive epoxy onto various substrates such as alumina as well as standard PC Board material. Solder attachment is NOT recommended.

*Also available with Tin/Lead terminations for reflow soldering.

Engineering Information

*Dissipation Constant (mW/C):	Dependent on mounting
*Thermal Time Constant (sec.):	Dependent on mounting
Resistance Coefficient:	See PTC table 1
Mounting:	Conductive epoxy
Power Rating:	0.0625 watts @ 25°C derated to +125°C (Table 1)
Operating Range:	-55°C to 125°C

Standard Configuration

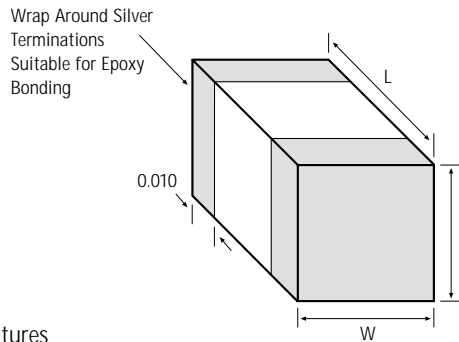
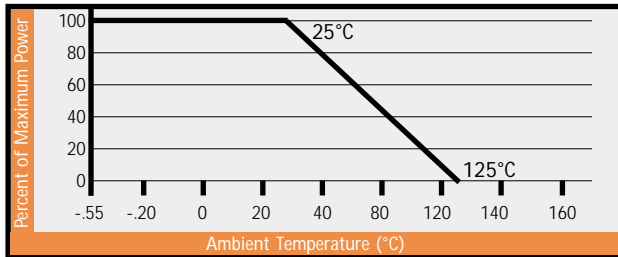
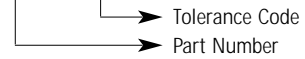

TABLE 1 Derating Curve for High Ambient Temperatures



Ordering Information

QTCH-102J



- Tolerance:**
- K = 10%
 - J = 5%
 - G = 2%
 - F = 1%

TABLE 2 Part Dimensions

RESISTANCE @ 25°C (OHMS)	PART NO.	W +/- 0.005	T +/- 0.005	L +/- 0.010	NOMINAL *D.C.	NOMINAL *T.C.
33	QTCH-330X	.030	.020	.050	2mW/C	8 sec.
47	QTCH-470X	.030	.022	.050	2mW/C	8 sec.
100	QTCH-101X	.030	.030	.050	2mW/C	8 sec.
330	QTCH-331X	.030	.020	.050	2mW/C	8 sec.
470	QTCH-471X	.030	.023	.050	2mW/C	8 sec.
1000	QTCH-102X	.030	.016	.050	2mW/C	8 sec.
3300	QTCH-332X	.030	.020	.050	2mW/C	8 sec.

TABLE 3 Resistance Multipliers at Specified Temperature

TEMPERATURE	10 TO 68 OHMS	82 TO 150 OHMS	180 TO 470 OHMS	560 TO 1200 OHMS	1500 TO 5600 OHMS	6800 TO 10,000 OHMS
**(-55°C)	0.615	0.582	0.560	0.550	0.515	0.510
-15°C	0.790	0.770	0.755	0.740	0.730	0.730
0°C	0.863	0.847	0.838	0.835	0.825	0.825
25°C	1.000	1.000	1.000	1.000	1.000	1.000
50°C	1.160	1.170	1.180	1.200	1.230	1.190
75°C	1.350	1.370	1.400	1.420	1.450	1.400
100°C	1.545	1.584	1.623	1.656	1.670	1.610
** (125°C)	1.750	1.800	1.860	1.920	1.960	1.830

**Multipliers applicable to military grade only.

PTC Military Grade Thermistors

Military Grade Leaded Thermistors

RTH42 and RTH22 Military Grade PTC thermistors meet or exceed the requirements of MIL-PRF-23648 including:

- Short time overload
- Low temperature storage
- High temperature storage
- Terminal strength
- Thermal shock
- Resistance to soldering heat
- Moisture resistance
- Life
- High temperature exposure
- Vibration, high frequency
- Shock, specified pulse
- Seal
- Immersion
- Resistance to solvents

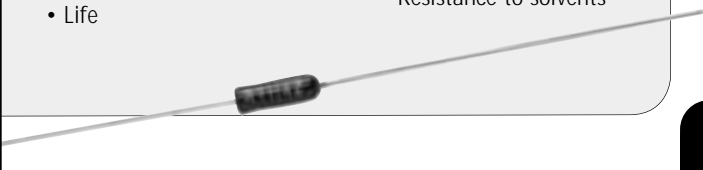

Ordering Information

RTH42ES 202J

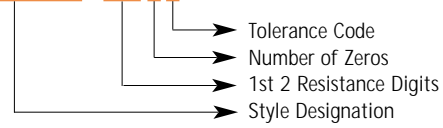

Tolerance:
K = 10%
J = 5%

Any of the above tests, or tests dictated by your application, can be performed at Quality Thermistor on the specific lot you are ordering. Contact QTI Technical Support for details.

*COMMERCIAL GRADE AVAILABLE, CONTACT FACTORY FOR DETAILS

TYPE	OPERATING TEMP. RANGE	STANDARD RESISTANCE RANGE	POWER RATING AT 25°C IN WATTS	THERMAL TIME CONSTANT SECONDS MAXIMUM
RTH22 MIL-PRF-23648/9 	-55°C TO +125°C	10 – 10K ohms	.500 @ 25°C derate per Table 4	60
RTH42 MIL-PRF-23648/19 	-55°C TO +125°C	10 – 10K ohms	.250 @ 25°C derate per Table 4	60

PTC TABLE 1 Resistance Multipliers for RTH42

TEMPERATURE	10 TO 68 OHMS	82 TO 150 OHMS	180 TO 470 OHMS	560 TO 1200 OHMS	1500 TO 5600 OHMS	6800 TO 10,000 OHMS
-55°C	0.615	0.582	0.560	0.550	0.515	0.510
-15°C	0.790	0.770	0.755	0.740	0.730	0.730
0°C	0.863	0.847	0.838	0.835	0.825	0.825
25°C	1.000	1.000	1.000	1.000	1.000	1.000
50°C	1.160	1.170	1.180	1.200	1.230	1.190
75°C	1.350	1.370	1.400	1.420	1.450	1.400
100°C	1.545	1.584	1.623	1.656	1.670	1.610
125°C	1.750	1.800	1.860	1.920	1.960	1.830

PTC TABLE 2 Resistance Multipliers for RTH22

TEMPERATURE	10 TO 68 OHMS	82 TO 150 OHMS	180 TO 560 OHMS	680 TO 1500 OHMS	1.8K TO 10K OHMS
-55°C	0.615	0.582	0.560	0.550	0.515
-15°C	0.790	0.770	0.755	0.740	0.730
0°C	0.863	0.847	0.838	0.835	0.825
25°C	1.000	1.000	1.000	1.000	1.000
50°C	1.160	1.170	1.180	1.200	1.230
75°C	1.350	1.370	1.400	1.420	1.450
100°C	1.545	1.584	1.623	1.656	1.670
125°C	1.750	1.800	1.860	1.920	1.960

PTC TABLE 3 Device Tolerance at Temperatures Other Than 25°C

SEQUENCE	TEMPERATURE	J +/-%	K +/-%
1	-55°C	20	25
2	-15°C	13	18
3	0°C	7	12
4	25°C	5	10
5	50°C	7	12
6	75°C	9	14
7	100°C	12	17
8	125°C	15	20

TABLE 4 Derating Curve for High Ambient Temperatures

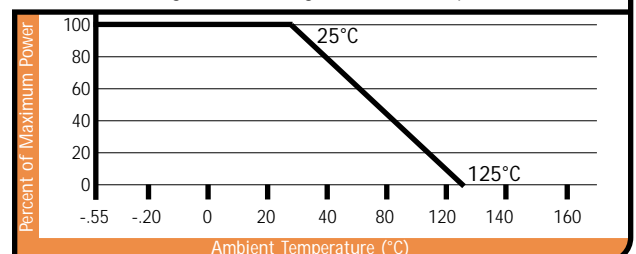

PTC Military Grade Thermistors

Military Grade PTC THERMISTORS

Military Grade Chip Thermistors

The High-Rel Positive Temperature Coefficient chip thermistor is designed for wire bonding applications found in hybrid circuitry. The devices exhibit a linear Resistance vs. Temperature curve approximating 0.7%/C which make them the ideal solution for temperature compensation applications.

DSCC (Defense Supply Center, Columbus) issued specification MIL-PRF-32192 dictating the performance and inspection requirements for these devices which includes a test for wire bonding integrity. Many leading Aerospace companies around the world have selected these components for their mission critical space flight applications.

Quality Thermistor has summarized the requirements of the MIL-PRF-32192 specification on this catalog page. The complete detailed MIL-PRF-32192 specification can be obtained by contacting the DSCC.

Quality Thermistor, Inc. is AS9100 certified

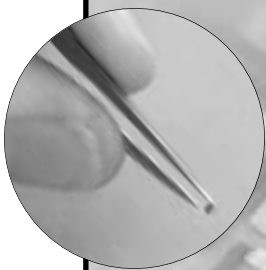

Engineering Information

Thermal time constant: 30 seconds max in still air
 Power rating: .125 W at 25 c, derate to 0 at 125
 Dissipation constant: 1.25mW/°C min in still air
 Resistance at 25C: 10 ohms to 10Kohms (see table)

Standard Configuration

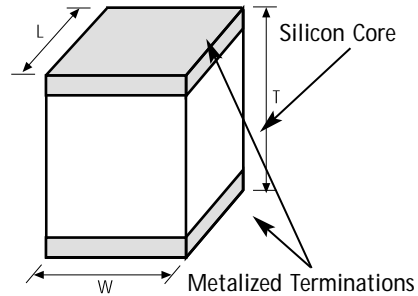

Dimension +/- .010 (0.254)	10-12 OHMS	15-1800 OHMS	2200-4700 OHMS	5600 OHMS	10000 OHMS
L	0.032(0.812)	0.032(0.812)	0.038(0.965)	0.030(0.762)	0.022(0.558)
W	0.032(0.812)	0.032(0.812)	0.038(0.965)	0.030(0.762)	0.022(0.558)
T	0.028(0.711)	0.050(1.27)	0.072(1.828)	0.072(1.828)	0.072(1.828)

Ordering Information

M32192 E 1 W 500 1 J M

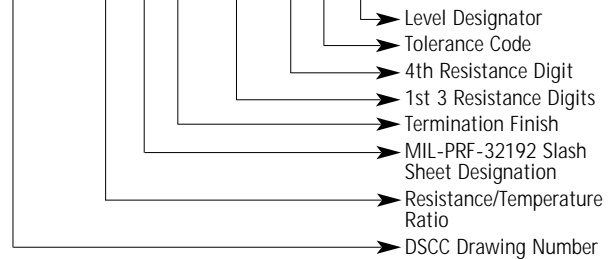

TABLE 1 Derating Curve for High Ambient Temperatures

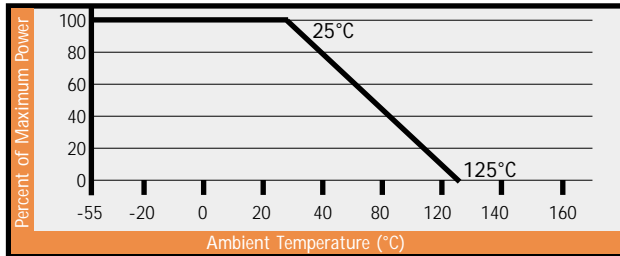

TABLE 2 Factors for determining resistance at various temperatures.

TEMPERATURE °C	10-27 OHMS	33-68 OHMS	82-330 OHMS	390-2.7k OHMS	3.3k-10k OHMS
-55°C	0.552	0.519	0.493	0.481	0.493
-15°C	0.739	0.728	0.716	0.709	0.717
0°C	0.830	0.822	0.813	0.810	0.816
25°C	1.000	1.000	1.000	1.000	1.000
50°C	1.190	1.201	1.208	1.211	1.205
75°C	1.408	1.411	1.441	1.446	1.430
100°C	1.651	1.669	1.706	1.709	1.660
125°C	1.908	1.940	1.993	1.983	1.862

TABLE 4 Termination Materials

TYPE	MATERIAL	CODE
Epoxy Bondable	Gold	G
Epoxy Bondable	Platinum Gold	U
Epoxy Bondable	Platinum Gold	T
Epoxy Bondable	Palladium Silver or Platinum Silver	C
Epoxy Bondable	Palladium Silver or Platinum Silver	D
Wire Bondable	Silver	S
Wire Bondable	Gold	W

TABLE 3 Resistance tolerance at temperatures other than 25°C.

TEMPERATURE °C	F PERCENT (±)	G PERCENT (±)	J PERCENT (±)	K PERCENT (±)
-55°C	15	17	20	25
-15°C	9	10	13	18
0°C	3	4	7	12
25°C	1	2	5	10
50°C	3	4	7	12
75°C	5	6	9	14
100°C	7	9	12	17
125°C	10	12	15	20

PTC Military Grade Thermistors

Military Grade Surface Mount Thermistors

MIL-PRF-32192/2 PTC Surface Mount Thermistors exhibit a stable, proportional and resistance vs. temperature signal approximating 0.7%/°C.

DSCC (Defense Supply Center, Columbus) issued specification MIL-PRF-32192/2 which dictates the performance and inspection requirements for these Thermistors. Many leading Aerospace companies around the world have selected these components for their mission critical applications.

Quality Thermistor has summarized the requirements of the MIL-PRF-32192/2 Specification on this catalog page. The complete detailed MIL-PRF-32192/2 Specification can be obtained by contacting DSCC (Defense Supply Center, Columbus).



Military Grade: (22Ω to 5.6KΩ)

- Positive Temperature Coefficient: 0.7%/°C
- Operating Temperature Range: -55°C to +125°C
- Storage Temperature: -65°C to 150°C
- Thermal Time Constant: 30 seconds max. – Still Air
- Dissipation Constant: 2.5mW/°C min. – Still Air
- Power Rating: 0.250 Watts @ 25°C derated to 125°C (Table 1)

Recommended solder reflow peak: 230°C for less than 10 sec.

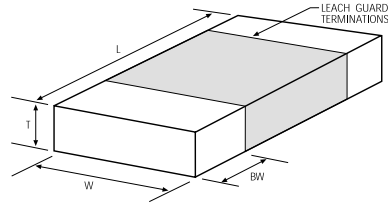

Dimensions MIL-PRF-32192/2 PTC STYLE

- L = .078" +/- .008"
- W = .049" +/- .008"
- T = .055" Max
- BW = .020" +/- .005"

Ordering Information

M32192 E 2 B 100 1 J M

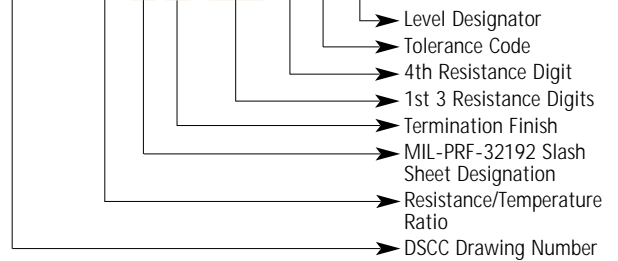

TABLE 1 Derating Curve for High Ambient Temperatures

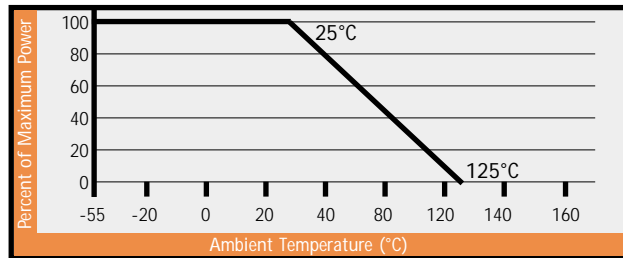

TABLE 2 Factors for determining resistance at various temperatures.

TEMPERATURE °C	22-27 OHMS	33-68 OHMS	82-330 OHMS	390-2.7k OHMS	3.3k-5.62k OHMS
-55°C	0.552	0.519	0.493	0.481	0.493
-15°C	0.739	0.728	0.716	0.709	0.717
0°C	0.830	0.822	0.813	0.810	0.816
25°C	1.000	1.000	1.000	1.000	1.000
50°C	1.190	1.201	1.208	1.211	1.205
75°C	1.408	1.411	1.441	1.446	1.430
100°C	1.651	1.669	1.706	1.709	1.660
125°C	1.908	1.940	1.993	1.983	1.862

TABLE 4 Termination Materials

TYPE	MATERIAL	CODE
Solderable	Base metalization barrier metal, solder coated	B
Epoxy Bondable	Gold	G
Epoxy Bondable	Platinum Gold	U
Epoxy Bondable	Platinum Gold	T
Epoxy Bondable	Palladium Silver or Platinum Silver	C
Epoxy Bondable	Palladium Silver or Platinum Silver	D
Wire Bondable	Silver	S
Wire Bondable	Gold	W

TABLE 3 Resistance tolerance at temperatures other than 25°C.

TEMPERATURE °C	F PERCENT (±)	G PERCENT (±)	J PERCENT (±)	K PERCENT (±)
-55°C	15	17	20	25
-15°C	9	10	13	18
0°C	3	4	7	12
25°C	1	2	5	10
50°C	3	4	7	12
75°C	5	6	9	14
100°C	7	9	12	17
125°C	10	12	15	20

Basic Temperature Measurement Using Thermistors

Temperature measurement can be accomplished with a simple Wheatstone bridge as illustrated, or in any configuration where the voltage across or current through the thermistor can be measured.

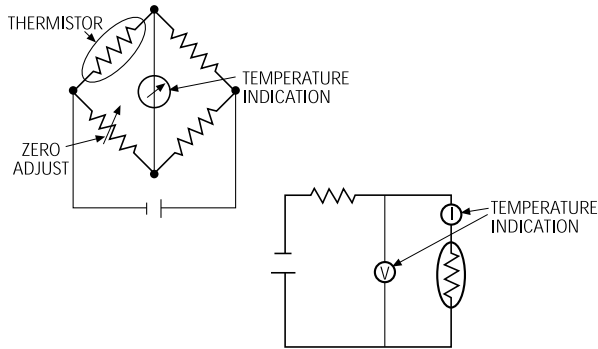

Basic temperature control

By using a thermistor in a voltage comparator circuit basic on-off temperature control as well as over-temperature protection can be incorporated.

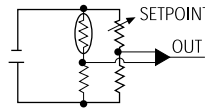

PWM precision temperature control

The following circuit uses a thermistor as a sensor for precision temperature control.

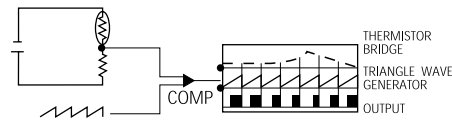

Temperature Compensation Using Thermistors

Most electronic components and assemblies are temperature sensitive to some extent, and circuit precision often necessitates some sort of temperature compensation. Oscillators, coils, and amplifiers are examples of circuits that are commonly in need of temperature compensation. Thermistors are easily utilized for general temperature compensation.

Circuits and components can use either active or passive compensation. Active compensation utilizes the thermistor as a sensing element which drives an active compensation circuit, whereas passive compensation uses a thermistor in a configuration to offset an element's characteristic R-T response. Active compensation is more suitable to applications where the temperature of an entire assembly is in question, where passive compensation focuses on a critical component.

The first step in electronic temperature compensation is to determine the R-T characteristic of the circuit or component which is to be compensated. The appropriate thermistor compensation network is then determined to inversely match this response as closely as possible.

Active Compensation

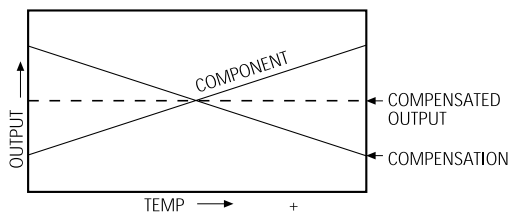

The following circuit is an example of a thermistor used to compensate a power supply. Assume that as temperature of the power supply board increases, the output voltage of the supply drifts in a negative direction. The thermistor is placed on the power supply in a location where the thermistor resistance accurately reflects the temperature of the supply circuit. As the supply heats up, the compensation amplifier voltage increases. The output of the power supply and the compensation amplifier are then fed through a summing amplifier, stabilizing the final output.

Passive Compensation

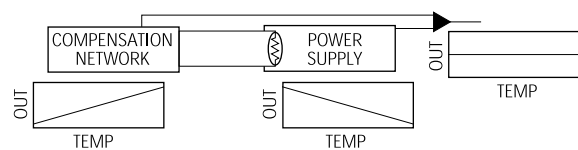

Assume the following component has the given R-T transfer characteristics. By incorporating the thermistor into the component biasing circuit, the effects of component temperature rise can be negated.

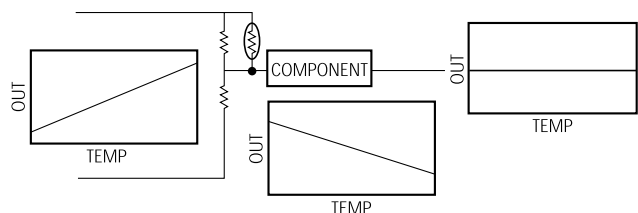

Computer Interfacing to an NTC Thermistor

Using a precision NTC thermistor as a sensor for a uC or computer based instrument can be accomplished in a fairly straightforward manner. A thermistor/resistor voltage divider bridge can supply a strong signal to an A-D converter, which can then be interfaced to the desired instrument (Fig. 1). Using the entire range of the thermistor (-55°C to 125°C), a 12 bit A-D can give a resolution of .04°C, a 10 bit .175°C and an 8 bit .70°C. Since an NTC thermistor exhibits a nonlinear change in resistance with a linear change in temperature, the voltage output of the bridge must be interpreted for the actual temperature. This can be accomplished with an R-T look up table, or through the use of an equation which characterizes the thermistor response.

Application Using An R-T Look Up Table

Using this method, the A-D count is simply used as an offset to correlate to the temperature recorded in the table. The table is created by calculating or measuring the A-D count when the thermistor is at a given temperature or resistance value, and recording this in the table. This method has the advantage of the ability to manipulate the table to fit a particular thermistor's R-T characteristic very closely.

The following example uses a 10K ohm thermistor/10K ohm fixed resistor bridge network, and an 8 bit A-D converter.

R-T multiplier @ -55°C = 96.4
 Thermistor R @ -55°C = 964K ohm
 Bridge voltage @ -55°C = 4.948V

R-T multiplier @ 125°C = .03461
 Thermistor R @ 125°C = 346.1 ohm
 Bridge voltage @ 125°C = .00048V

R-T multiplier @ 25°C = 1
 Thermistor R @ 25°C = 10K ohm
 Bridge voltage @ 25°C = 2.5V

Using these values, the A-D high ref would be set at 4.984V, and the low ref at .00048V, yielding $(4.984V-.00048V)/256$ count or $\sim .0194V$ per A-D count, giving the following:

A-D count at 125°C = 00000000, table element 0 = 125
 A-D count at -55°C = 11111111, table element 255 = -55
 A-D count at 25°C = $2.5V/.0194V = 128.8$ dec = 1000001bin, table element 129 = 25

The in-between values are calculated in the same manner. The number of values in the table can be any power of 2 up to the resolution of the A-D converter. By dividing the A-D count by the appropriate number and using linear interpolation between the table entry numbers, required table memory space can be reduced with a minimum decrease in accuracy.

```
DIM TABLE (255) AS SINGLE      'this is the lookup table
    TABLE (0) = 125
    :
    :
    TABLE (129) = 25
    :
    :
    TABLE (255) = -55

OPEN "A-D" FOR INPUT AS #1      'open A-D
INPUT #1, ADCOUNT              'and get count
TEMP = TABLE (ADCOUNT)        'get temperature at pointer
PRINT TEMP                     'and the final output in deg C
```

The following is an example in BASIC how to implement this using a 64 element lookup table and 8 bit A-D converter.

```
DIM TABLE (64) AS SINGLE      'this is the lookup table
    TABLE (0) = 125
    :
    :
    TABLE (32) = 25            'this is -129/4
    :
    :
    TABLE (63) = -55
    :
    :

OPEN "A-D" FOR INPUT AS #1    'open A-D
INPUT #1, ADCOUNT              'and get count
TABLEOFFSET = INT(ADCOUNT/4)  'divide by 4 for lookup table of 64
                                'elements. Round result to next
                                'lowest integer value
TEMP = TABLE (TABLEOFFSET)   'get temperature at pointer
NEXTTEMP = TABLE (TABLEOFFSET+1) 'get temperature above pointer
                                '(next 'pointer location). Actual
                                'temperature 'is between these
                                'two.
DIFFTEMP = ABS (ADCOUNT-(TEMP*4))
                                'this is the distance from TEMP
                                ''between TEMP and NEXTTEMP
                                'This is the interpolated tempera-
                                'ture.
                                'Remember that values in table
                                ''decrease as the A-D count
                                'increases.
                                'Note that this assumes that
                                'a table
                                ''point lies on 0. If there is no
                                '0 entry
                                ''separating positive and negative
                                ''table entries, some additional
                                ''conditions must be added to
                                ''correctly interpolate.

INTERPTEMP = TEMP + (((TEMP-NEXTTEMP)/4)*DIFFTEMP)
PRINT INTERPTEMP              'and the final output in deg C
```

Computer Interfacing to an NTC Thermistor

Application Using Thermistor Characterization Equation

The equation for thermistor characterization is known as the Steinhart-Hart equation. This equation requires the computation of the coefficients a, b, c and d. These can also be obtained from the thermistor manufacturer. The resulting temperature is given in degrees K. The following BASIC program demonstrates this method, using the same circuit as above, with A-D high ref = bridge voltage (5V) and A-D low ref at 0V.

```
a = ?           'these constants need to be
b = ?           'entered
c = ?
d = ?
resolution = 256 'for 8 bit A-D
vref = 5        'bridge voltage
rfix = 10000    'fixed bridge resistor

OPEN "A-D" FOR INPUT AS #1 'open A-D
INPUT #1, ADCOUNT 'and get count
VBRIDGE = ADCOUNT*(vref/resolution) 'convert to voltage across
                                     thermistor
RATHERM = VBRIDGE/((vref-VBRIDGE)/rfix) 'find thermistor resistance

                                     'convert to temperature using given
                                     'coefficients and equation. This is
                                     'the standard Steinhart-Hart equation,
                                     'with the 273.15 added to yield
                                     'deg C.

TEMP = (1/(a + b*(lnRATHERM) + c*(lnRATHERM)^2
+ d*(lnRATHERM)^3)) - 273.15

PRINT TEMP           'and the final output in deg C
```

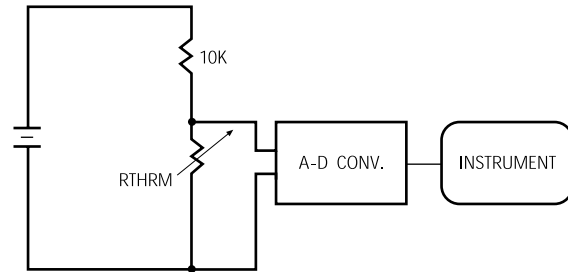

Quality Thermistor, Inc., Boise, Idaho

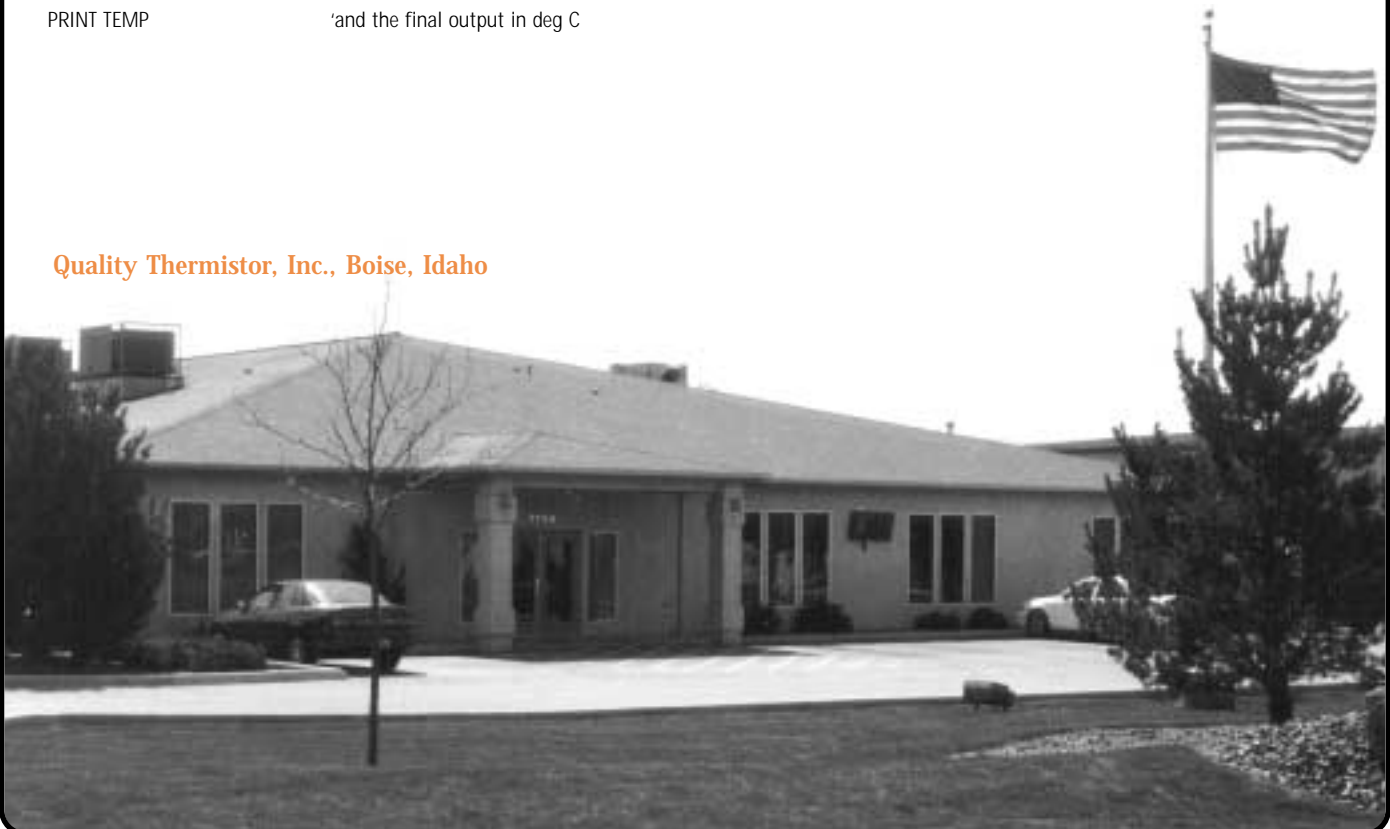

Special Services

Qualified Test Lab

To ensure the quality of our QTI brand thermistors, Quality Thermistor has an extensive test lab for a wide range of testing services. In addition, this facility is available to customers for the following services:

- Power burn-in
- Temperature cycling
- Moisture testing
- Shock and vibration testing
- Temperature characterization
- Space-level screening
- QCI Military testing



Custom Design

With a full staff of experienced temperature application engineers, Quality Thermistor can provide custom design services at any step along the design process. Expert in temperature measurement, compensation, and control, Quality Thermistor engineers can work with your in-house engineers or contractors, or as a full-support design team to solve your application.

- Components
- Probes
- Boards
- Systems
- Control and signal conditioning

Private Labeling

The QTI brand is recognized in many industries for high-quality manufacturing and measurement accuracy and reliability. However, in situations where private labeling is required, Quality Thermistor will provide components with no label or with your label to ensure the integrity of your branding strategy.

- Your design, your label
- Our design, your label
- Your design, the QTI label

Assembly

Quality Thermistor offers expert, timely component and board assembly services in our well-equipped Tecate, Mexico, facility. In addition, to ensure product is delivered on time, the facility's capability is mirrored at our Idaho plant.

- Highly-trained assemblers
- High-volume production
- Competitive prices
- Probe assembly
- PTC and NTC devices

