

# SF51G thru SF58G

## Glass Passivated Junction Ultra Fast Rectifiers Reverse Voltage 50 to 600V Forward Current 5.0A

### FEATURES

- \* Plastic package has Underwriters Laboratory Flammability Classification 94V-0
- \* High temperature metallurgically bonded construction
- \* Glass passivated chip
- \* Capable of meeting environmental standards of MIL-S-19500
- \* For use in high frequency rectifier circuits
- \* Fast switching for high efficiency
- \* High temperature soldering guaranteed: 260°C/10 seconds
- \* 0.375" (9.5mm) lead length, 5 lbs. (2.3kg) tension

### Mechanical Data

**Case:** JEDEC DO-201AD, molded plastic  
**Terminals:** Plated axial leads, solderable per MIL-STD-750, Method 2026  
**Polarity:** Color band denotes cathode end  
**Mounting Position:** Any  
**Weight:** 0.038 oz., 1.03 g  
**Handling precaution:** None

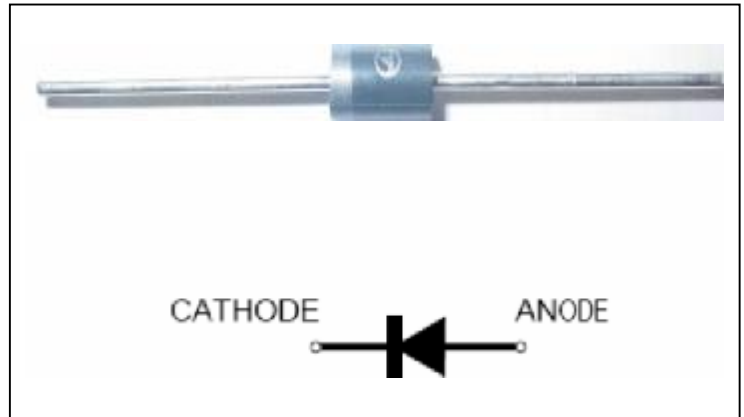

We declare that the material of product compliance with ROHS requirements

### 1. Maximum & Thermal Characteristics Ratings at 25°C ambient temperature unless otherwise specified.

Parameter Symbol	symbol	SF51G	SF52G	SF53G	SF54G	SF55G	SF56G	SF57G	SF58G	Unit
Marking spec		SF51G	SF52G	SF53G	SF54G	SF55G	SF56G	SF57G	SF58G	
Maximum repetitive peak reverse voltage	$V_{RRM}$	50	100	150	200	300	400	500	600	V
Maximum RSM voltage	$V_{RSM}$	35	70	105	140	210	280	350	420	V
Maximum DC blocking voltage	$V_{DC}$	50	100	150	200	300	400	500	600	V
Maximum average forward rectified current 0.375" (9.5mm) lead length at $T_A = 55^\circ\text{C}$	$I_{F(AV)}$	5.0								A
Peak forward surge current 8.3ms single half sine-wave superimposed on rated load (JEDEC Method)	$I_{FSM}$	150								A
Maximum DC blocking voltage temperature	$T_A$	150								°C
Typical thermal resistance (Note 2)	$R\theta_{JA}$	20								°C/W
Operating junction temperature range	$T_J$	-50 to +150								°C
Storage temperature range	$T_{STG}$	-50 to +150								°C

### Electrical Characteristics Ratings at 25°C ambient temperature unless otherwise specified.

Parameter Symbol	symbol	SF51G	SF52G	SF53G	SF54G	SF55G	SF56G	SF57G	SF58G	Unit	
Maximum instantaneous forward voltage at 5.0A	$V_F$	0.95			1.25		1.7			V	
Maximum DC reverse current $T_A = 25^\circ\text{C}$ at rated DC blocking voltage $T_A = 125^\circ\text{C}$	$I_R$	10									$\mu\text{A}$
Typical reverse recovery time (Note 1)	$t_{rr}$	35									ns
Typical junction capacitance at 4.0V, 1MHz	$C_J$	50			30					PF	

NOTES:

1.  $I_F = 0.5\text{A}$ ,  $I_R = 1.0\text{A}$ ,  $IRR = 0.25\text{A}$
2. Thermal resistance from junction to ambient at 0.375" (9.5mm) lead length, P.C.B. mounted

# SF51G thru SF58G

## 2. Ratings and Characteristic Curves (TA = 25°C unless otherwise noted)

Fig. 1 - Forward Current Derating Curve

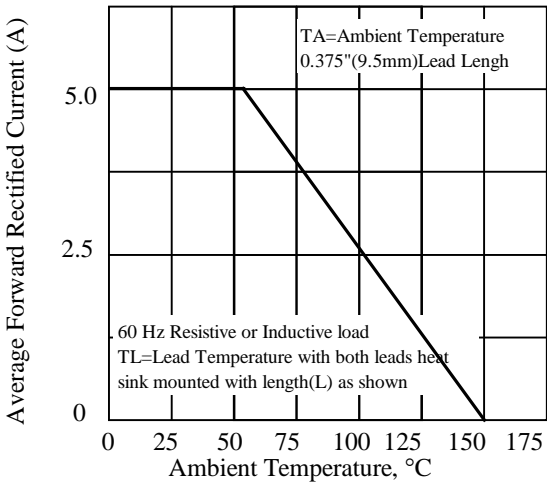

Fig. 2 - Maximum Non-repetitive Peak Forward Surge Current

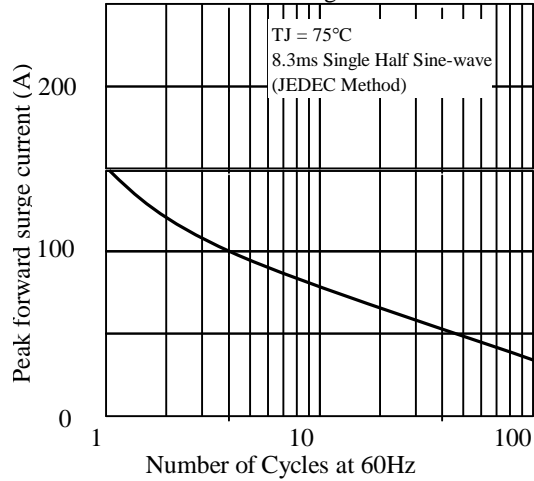

Fig. 3 - Typical Instantaneous Forward Characteristics

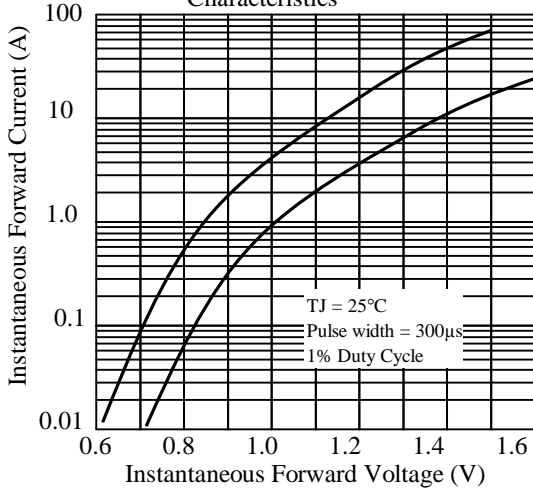

Fig. 4 - Typical Reverse Characteristics

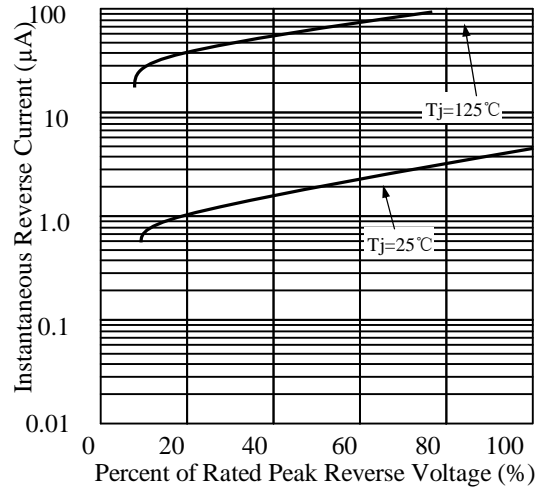

Fig. 5 - typical transient thermal impedance

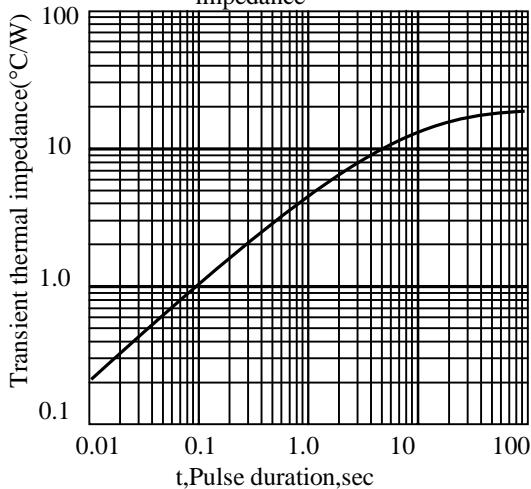
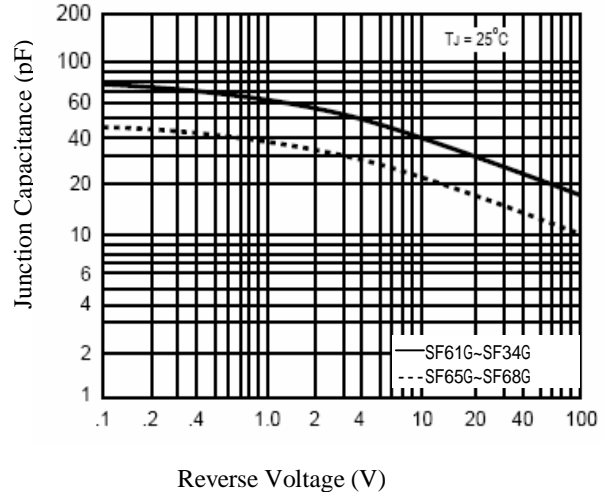
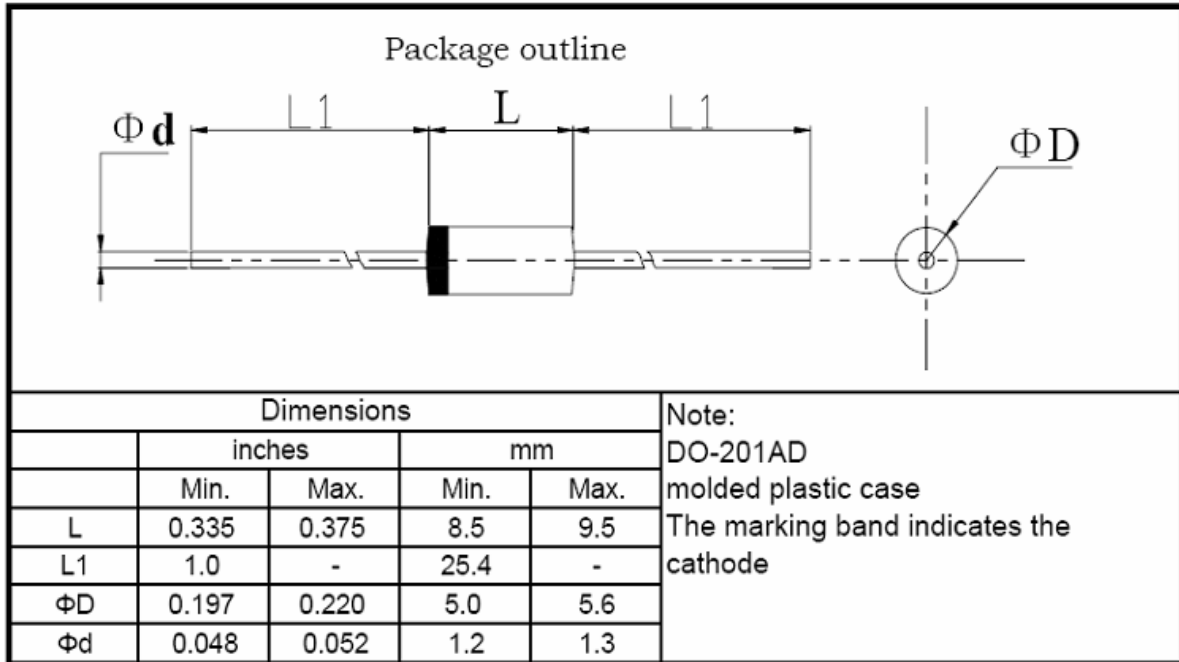

Fig. 6 - Typical Junction Capacitance



## SF51G thru SF58G

### 3. dimension:



标题：  <b>塑封生产线轴向产品包装规范</b>	文件编号： WI-250
	第 4 版 第 0 次修改
	第 1 页

- 1 弹带盒装 ammo and box
- 1.1. 弹带盒规格 ammo spec.

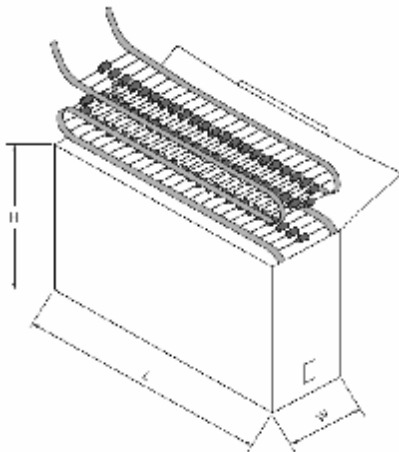

单位：mm

	L	W	H
T52	262±2	76±2	90±2
T42	262±2	64±2	90±2
T26	250±3	45±3	95±3

- 1.2 弹带内盒要求 inner box spec.

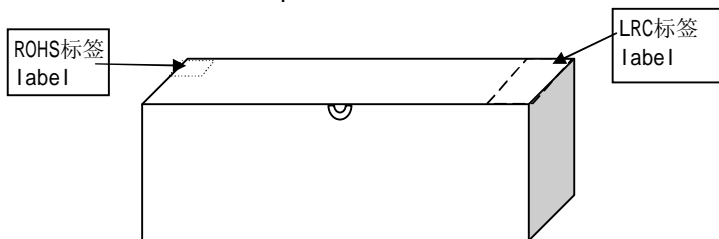

标题: <b>塑封生产线轴向产品包装规范</b>	文件编号: WI-250
	第 4 版 第 0 次修改
	第 2 页

1.4 标签要求 label spec.

1.4.1 LRC标签 LRC label

成型 FORMING \*\*\*\*\* ← 成型规格 forming spec.

型号 TYPE \*\*\*\*\* ← LRC产品型号 type

重复峰压 (V) PRV (V)	****	← 产品重复峰压值 peak repetitive voltage
额定电流 (A) I <sub>o</sub> (A)	**	← 产品额定电流值 average output current
数量 (只) QTY (pcs)	****	← 产品数量 quantity
检验员 CHECKER	02	
日期: DATE:	*****	← 产品生产日期 date

1.4.2 环保标签 environmental protection label



2. 外箱规格 carton spec.

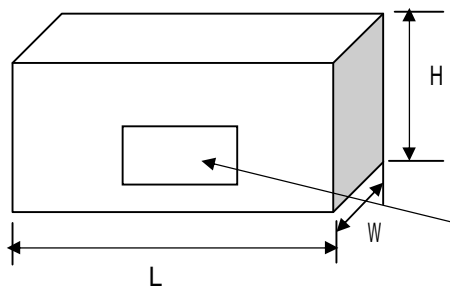

单位: mm

	L	W	H
T52	430±2	280±2	225±2
T42	410±2	285±2	300±2
T26	435±3	280±3	295±3

外箱标签 carton label

3 按以上包装方式, 编带数量和外包装箱产品数量: typing and carton spec.

	塑封外型			
	A-405 & DO-41 & R-1	R-3	DO-15	DO-201AD
每根编带数量 quantity/ammo	3K	1.8K	2K(T52) 1.8K(T26)	0.8K
外箱数量 (T52编带) quantity/cartoon	30K	18K	20K	8.0K
外箱数量 (T26编带) quantity/cartoon	60K	36K	36K	-
外箱数量 (T42编带) quantity/cartoon	54K	32.4K	36K	-

标题:

塑封生产线轴向产品包装规范

文件编号: WI-250

第 4 版 第 0 次修改

第 3 页

4 编带规格 brede spec



尺寸代号	编带尺寸 typing dimension					
	26/tape	35/tape	40/tape	42/tape	52/tape	52/tape#
<b>W</b>	26 0.0/+1.6	35 -1.0/+0.5	40 -1.0/+0.5	42 -1.0/+1.0	52 -1.0/+2.0	52 -1.0/+2.0
<b>P</b>	5±0.5	5±0.5	5±0.5	5±0.5	5±0.5	10±0.5
<b>L1-L2</b>	<1.0	<1.0	<1.0	<1.0	<1.0	<1.0
<b>H</b>	6±1.0	6±1.0	6±1.0	6±1.0	6±1.0	6±1.0
<b>Z</b>	<1.0	<1.0	<1.0	<1.0	<1.0	<1.0
<b>R</b>	<1.0	<1.0	<1.0	<1.0	<1.0	<1.0
<b>T</b>	>3.5	>3.5	>3.5	>3.5	>3.5	>3.5

注: 52编带# 为DO-201AD编带规格 "52编带#" just for D0-201AD

1. 红白编带厚度为0.05mm; 两种胶带各自之间无明显色差; 编带要求均为胶带。  
The typing thickness is 0.05mm and color is obvious difference
2. 两端引带20~40cm. Typing lead over 20~40cm
3. 红色编带一端为二极管“负极”; 白色编带一端为二极管“正极”。  
red color is cathode ,white color is anode
4. 无卤 green epoxy compound (无卤产品才贴HF only)

Green

## SF51G thru SF58G

### 4. Update Record

版次	更新记录	更新作者	更新日期
1	第一版	周杰	2010-6-22
2	增加包装规范	周杰	2011-6-30
3	增加SF57G	周杰	2012-2-13