

MODULAR CONNECTORS

CL 222 TM

Right Angle Dip Type

●TM5RC-**(50)

CL No.	Part No.	RoHS
222-0270-9-50	TM5RC-44 (50)	YES
222-0338-0-50	TM5RC-64 (50)	
222-0337-8-50	TM5RC-66 (50)	

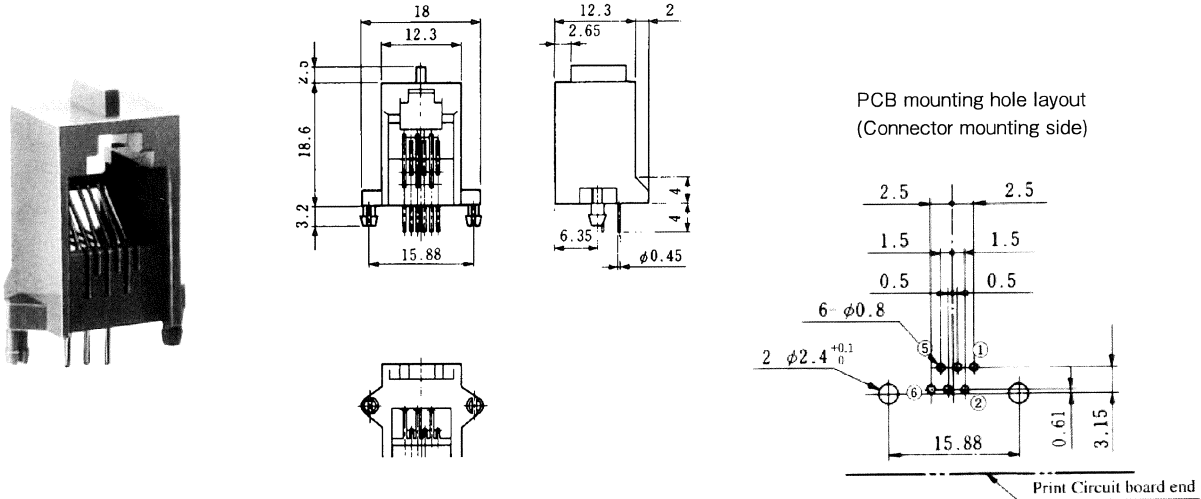

Note 1: Standard finish color is gray.

Note 2: The drawing is shown sample of TM5RC-66(50).

●TM5RC-88(50)

CL No.	Part No.	RoHS
222-0339-3-50	TM5RC-88 (50)	YES

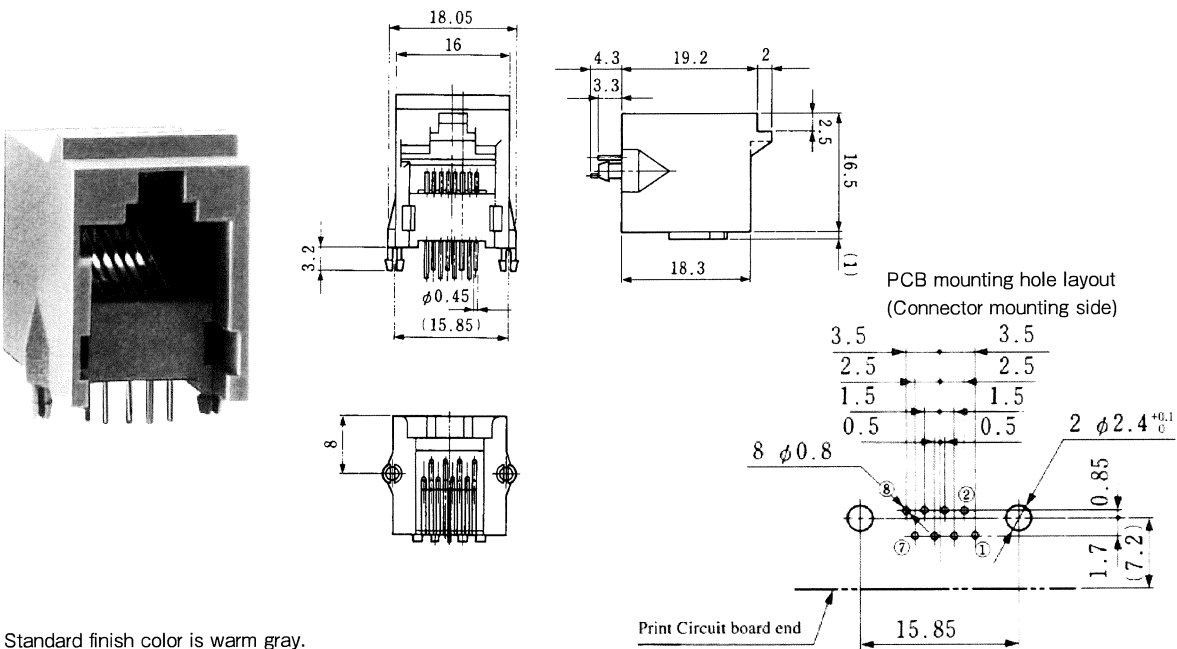

Note : Standard finish color is warm gray.

MODULAR CONNECTORS

CL 222 TM

●TM5RE1- ** (20)

CL No.	Part No.	A	B	C	RoHS
222-0538-0-20	TM5RE1-44 (20)	13	10.4	8	YES
222-0539-2-20	TM5RE1-62 (20)	15	12.4	10	
222-0540-1-20	TM5RE1-64 (20)	15	12.4	10	
222-0541-4-20	TM5RE1-66 (20)	15	12.4	10	

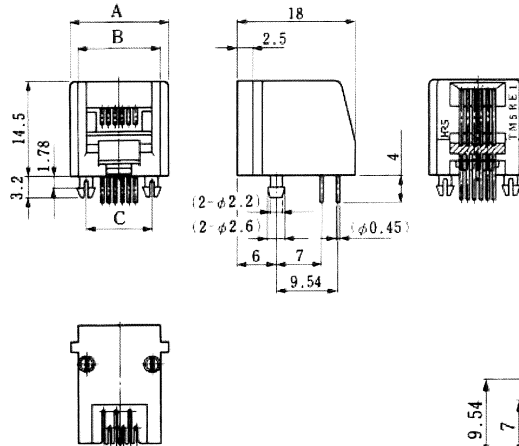
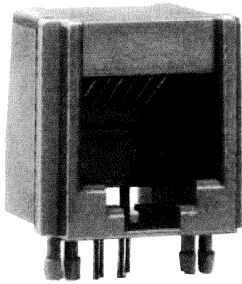

PCB mounting hole layout
(Connector mounting side)

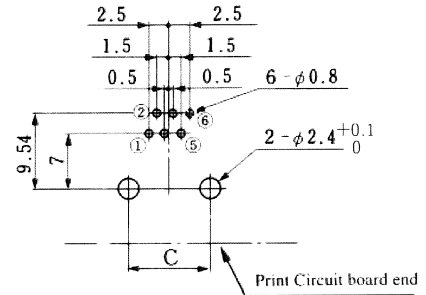

Note 1: Standard finish color is dark gray.
 Note 2: The drawing is shown sample of TM5RE1-66 (20).

●TM5RE2- ** (20)

CL No.	Part No.	A	B	C	RoHS
222-1222-1-20	TM5RE2-44 (20)	13	10.4	10.8	YES
222-1224-7-20	TM5RE2-62 (20)	15	12.4	12.8	
222-1223-4-20	TM5RE2-64 (20)	15	12.4	12.8	
222-1225-0-20	TM5RE2-66 (20)	15	12.4	12.8	

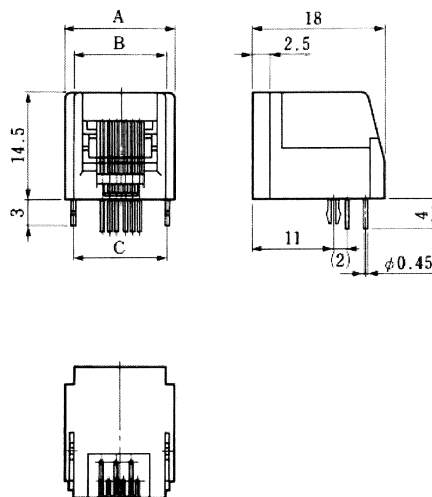
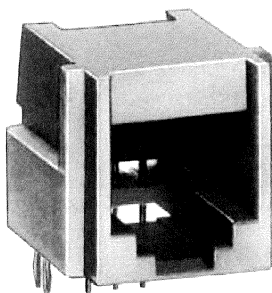

PCB mounting hole layout
(Connector mounting side)

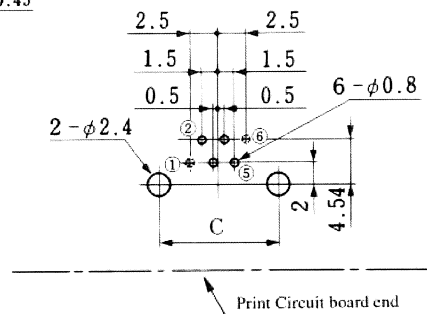

Note 1: Standard finish color is dark gray.
 Note 3: The drawing is shown sample of TM5RE2-66 (20).

MODULAR CONNECTORS

CL 222 TM

● TM5RE3-*(20)

CL No.	Part No.	A	B	C	RoHS
222-1406-4-20	TM5RE3-44 (20)	13	10.4	10.8	YES
222-1407-7-20	TM5RE3-62 (20)	15	12.4	12.8	
222-1427-4-20	TM5RE3-64 (20)	15	12.4	12.8	
222-1428-7-20	TM5RE3-66 (20)	15	12.4	12.8	
222-1702-7-20	TM5RE3-88 (20)	18.6	16	16.4	

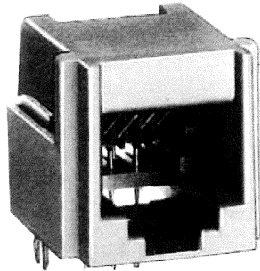

TM5RE3-66 (20)

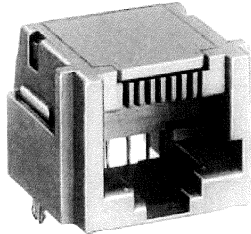

TM5RE3-88 (20)

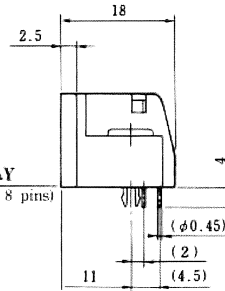
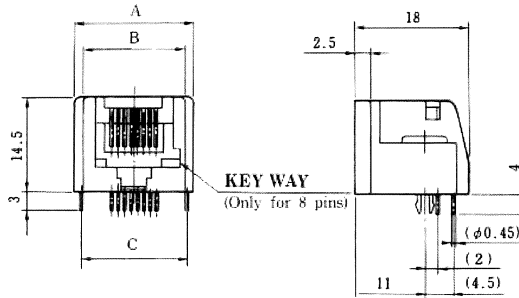

PCB mounting hole layout
(Connector mounting side)

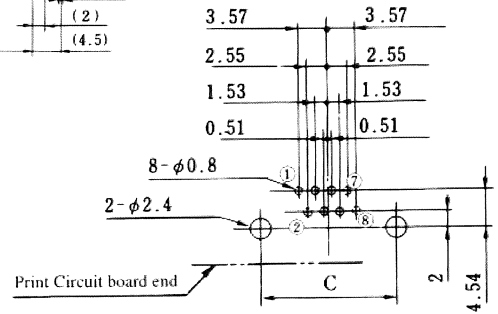

Note 1: Standard finish color is dark gray.

Note 2: The drawing is shown sample of TM5RE3-88 (20).

● TM5RF-44 (50)

CL No.	Part No.	RoHS
222-0391-3-50	TM5RF-44 (50)	YES

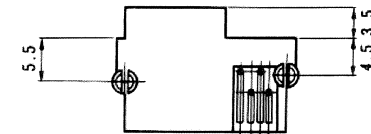
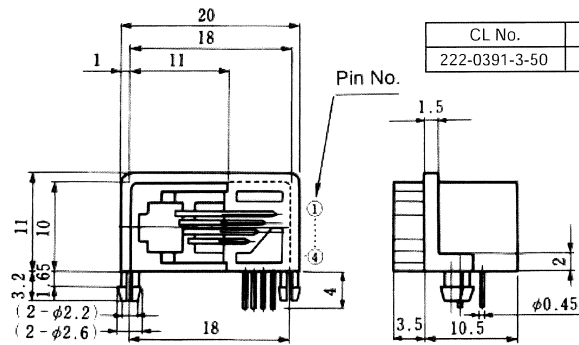
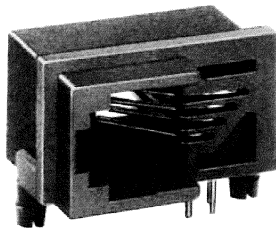

PCB mounting hole layout
(Connector mounting side)

C.L.: Center Line

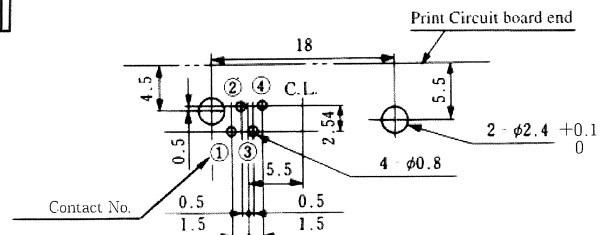

Note 1: Standard finish color is gray.

Note 2: Backboard size is shown the connector mounting side of PCB.

MODULAR CONNECTORS

CL 222 TM

●TM5RF-6 *(50)

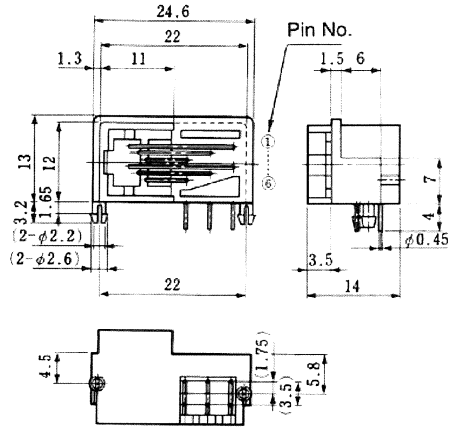
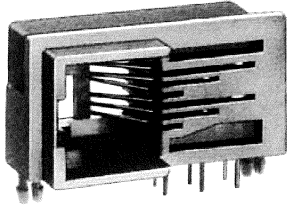

CL No.	Part No.	RoHS
222-1452-1-50	TM5RF-64 (50)	YES
222-1411-4-50	TM5RF-66 (50)	

PCB mounting hole layout
(Connector mounting side)

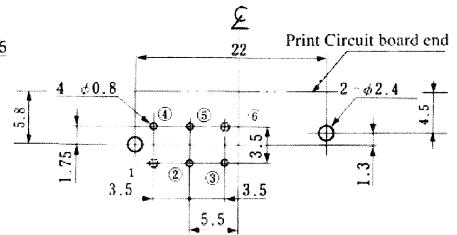

Note 1: Standard finish color is dark gray.
Note 2: The drawing is shown sample of TM5RF-66(50).

●TM5RF-1-44 (50)

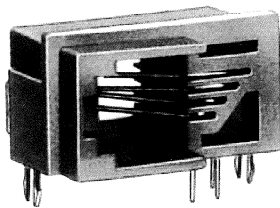

CL No.	Part No.	RoHS
222-1242-9-50	TM5RF1-44 (50)	YES

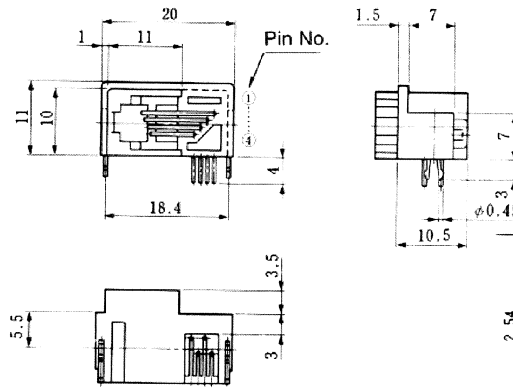

PCB mounting hole layout
(Connector mounting side)

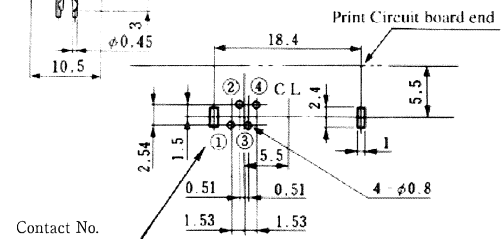

Note 1: Standard finish color is dark gray.

●TM5RF-1-6 *(50)

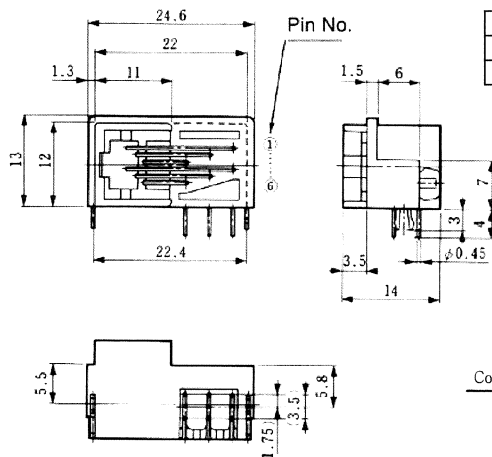
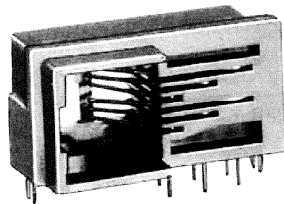

CL No.	Part No.	RoHS
222-1533-1-50	TM5RF1-64 (50)	YES
222-1534-4-50	TM5RF1-66 (50)	

PCB mounting hole layout
(Connector mounting side)

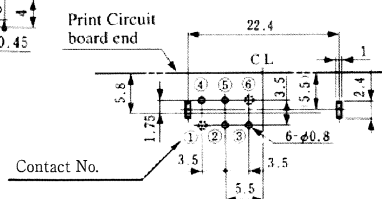

Note 1: Standard finish color is dark gray.
Note 2: The drawing is shown sample of TM5RF1-66(50).

MODULAR CONNECTORS

CL 222 TM

● TM5RJ2- ** (50)

CL No.	Part No.	A	B	C	RoHS
222-1459-0-50	TM5RJ2-44 (50)	12.8	10.2	10	YES
222-1486-3-50	TM5RJ2-62 (50)	14.8	12.2	12	
222-1460-0-50	TM5RJ2-64 (50)	14.8	12.2	12	
222-1461-2-50	TM5RJ2-66 (50)	14.8	12.2	12	
222-1462-5-50	TM5RJ2-88 (50)	18.6	16	15	

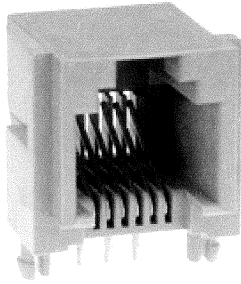

TM5RJ2-66 (50)

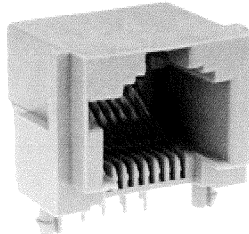

TM5RJ2-88 (50)

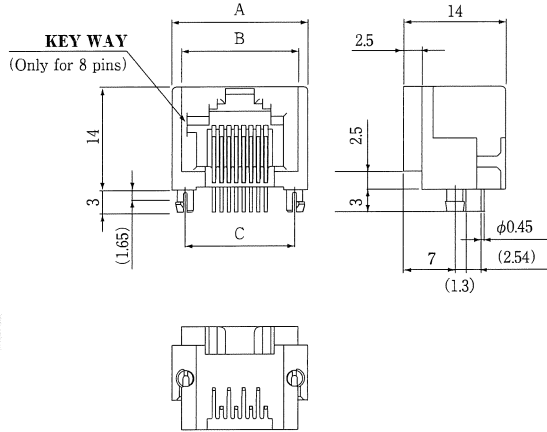

PCB mounting hole layout
(Connector mounting side)

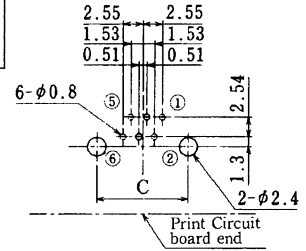

TM5RJ2-44,6*

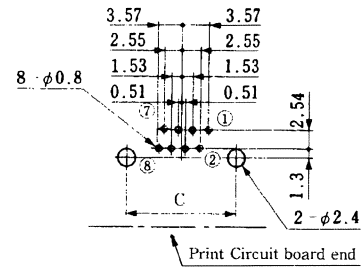

TM5RJ2-88 (50)

Note 1: Standard finish color is gray.

Note 2: The drawing is shown sample of TM5RJ2-88 (50).

● TM5RJ3- ** (50)

CL No.	Part No.	A	B	C	RoHS
222-1363-3-50	TM5RJ3-44 (50)	12.8	10.2	10.76	YES
222-1487-6-50	TM5RJ3-62 (50)	14.8	12.2	12.8	
222-1463-8-50	TM5RJ3-64 (50)	14.8	12.2	12.8	
222-1464-0-50	TM5RJ3-66 (50)	14.8	12.2	12.8	
222-1465-3-50	TM5RJ3-88 (50)	18.6	16	16.6	

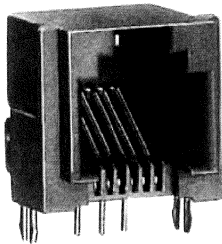

TM5RJ3-66 (50)

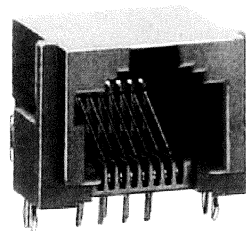

TM5RJ3-88 (50)

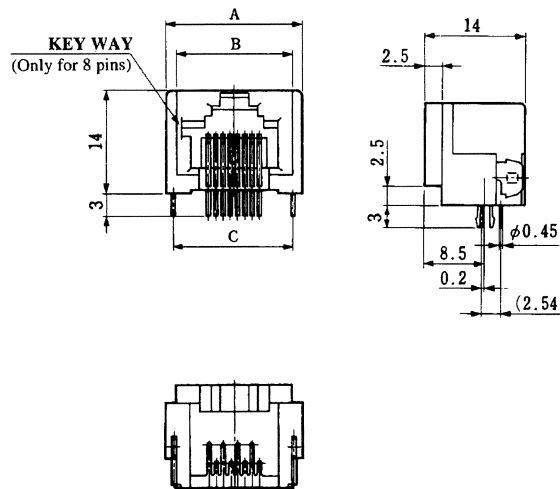

PCB mounting hole layout
(Connector mounting side)

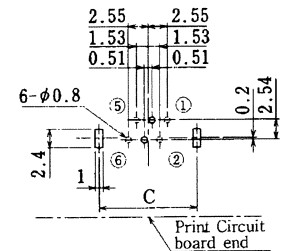

TM5RJ3-44, 6*

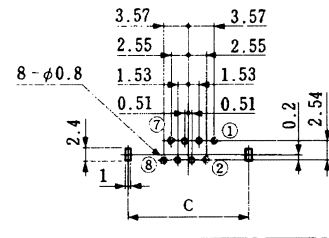

TM5RJ3-88 (50)

Note 1: Standard finish color is gray.

Note 2: The drawing is shown sample of TM5RJ3-88 (50).

MODULAR CONNECTORS

CL 222 TM

●TM5RU-6 *(50)

CL No.	Part No.	RoHS
222-2639-8-50	TM5RU-62 (50)	YES
222-2638-5-50	TM5RU-64 (50)	
222-2630-3-50	TM5RU-66 (50)	

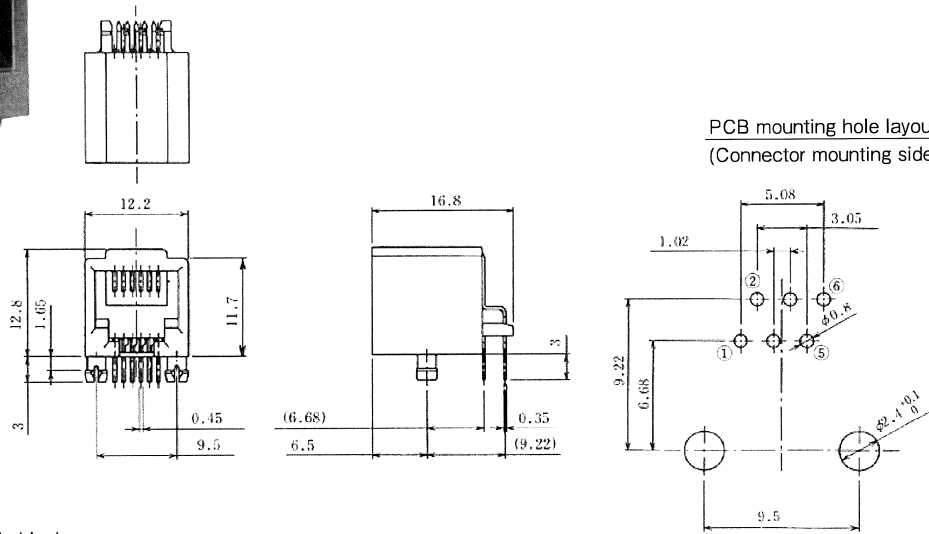
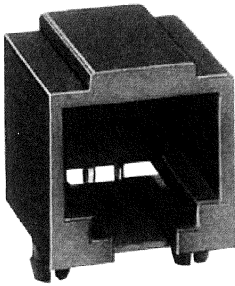

Note 1: Standard finish color is black.

Note 2: The drawing is shown sample of TM5RU-66(50).

MODULAR CONNECTORS

CL 222 TM

Gang-Jacks Right Angle Dip Type

●TM2REA-06 ** (50)

CL No.	Part No.	RoHS
222-1277-3-50	TM2REA-0602 (50)	YES
222-1466-6-50	TM2REA-0604 (50)	
222-1467-9-50	TM2REA-0606 (50)	

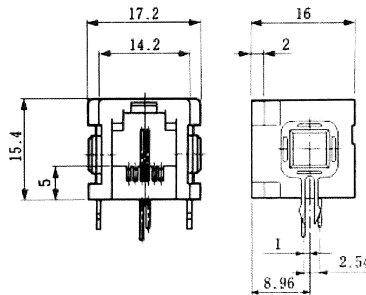
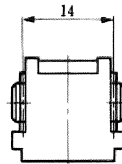
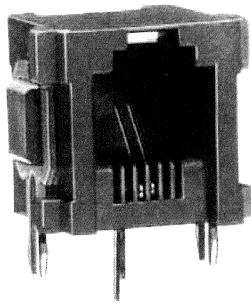

PCB mounting hole layout
(Connector mounting side)

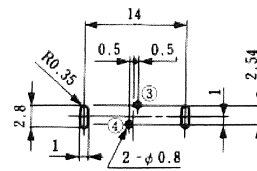

TM2REA-0602 (50)

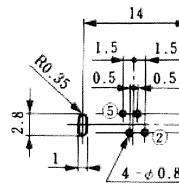

TM2REA-0604 (50)

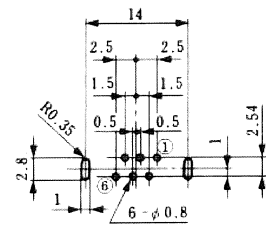

TM2REA-0606 (50)

Note 1: Standard finish color is gray.
 Note 2: The drawing is shown sample of TM2REA-0602 (50).

●TM2REA-12 ** (50)

CL No.	Part No.	RoHS
222-0802-6-50	TM2REA-1204 (50)	YES
222-0799-3-50	TM2REA-1208 (50)	
222-0681-3-50	TM2REA-1212 (50)	

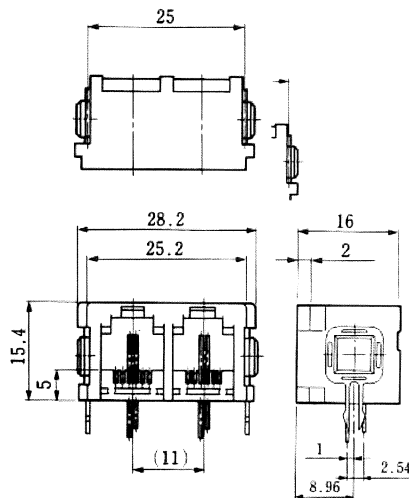
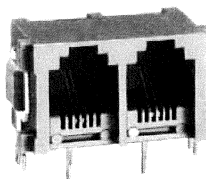

PCB mounting hole layout
(Connector mounting side)

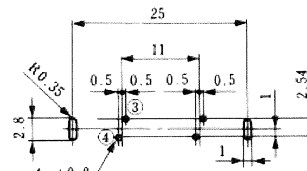

TM2REA-1204 (50)

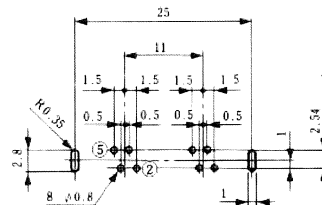

TM2REA-1208 (50)

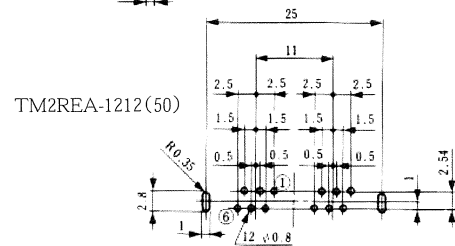

TM2REA-1212 (50)

Note 1: Standard finish color is gray.
 Note 2: The drawing is shown sample of TM2REA-1204 (50).

MODULAR CONNECTORS

CL 222 TM

● TM2REA-18 ** (50)

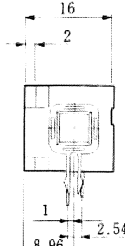
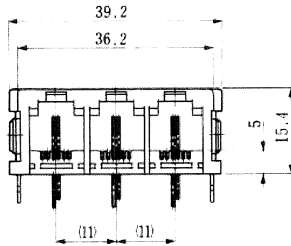
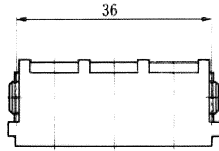
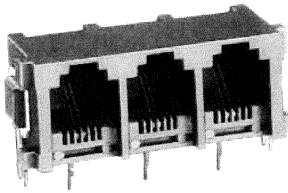

CL No.	Part No.	RoHS
222-0801-3-50	TM2REA-1806 (50)	
222-0798-0-50	TM2REA-1812 (50)	YES
222-0737-6-50	TM2REA-1818 (50)	

PCB mounting hole layout
(Connector mounting side)

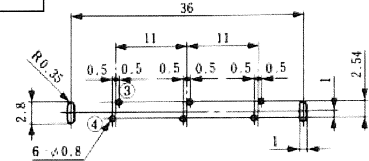

TM2REA-1806 (50)

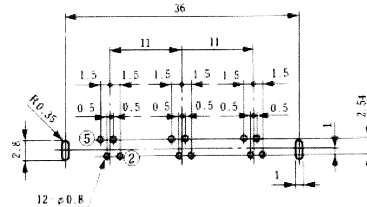

TM2REA-1812 (50)

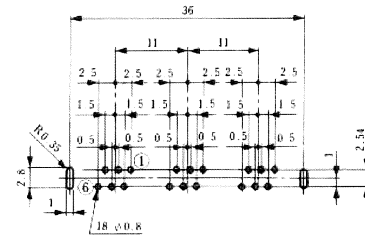

TM2REA-1818 (50)

Note 1: Standard finish color is gray.

Note 2: The drawing is shown sample of TM2REA-1806 (50).

● TM2REA-24 ** (50)

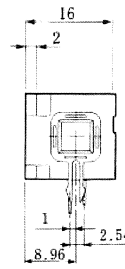
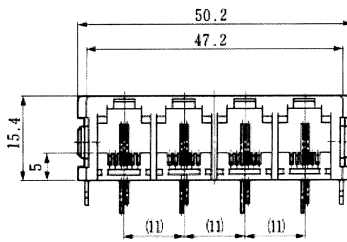
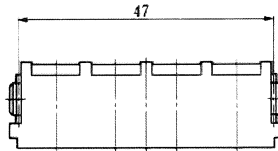
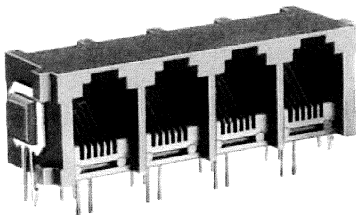

CL No.	Part No.	RoHS
222-0800-0-50	TM2REA-2408 (50)	
222-0749-5-50	TM2REA-2416 (50)	YES
222-0750-4-50	TM2REA-2424 (50)	

PCB mounting hole layout
(Connector mounting side)

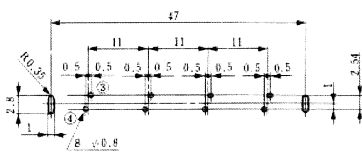

TM2REA-2408 (50)

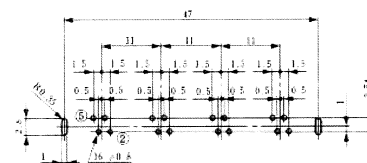

TM2REA-2416 (50)

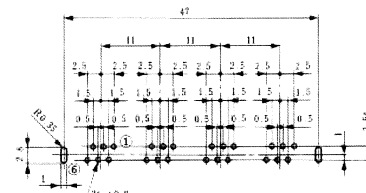

TM2REA-2424 (50)

Note 1: Standard finish color is gray.

Note 2: The drawing is shown sample of TM2REA-2416 (50).

MODULAR CONNECTORS

CL 222 TM

● TM5RQ-1414 (50)

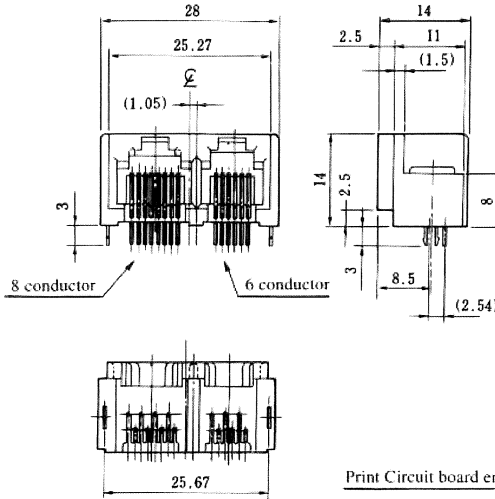
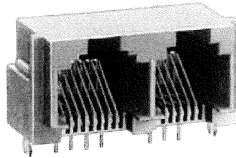

CL No.	Part No.	RoHS
222-1504-3-50	TM5RQ-1414 (50)	YES

PCB mounting hole layout
(Connector mounting side)

Note : Standard finish color is gray.

● TM5RQ-2020 (50)

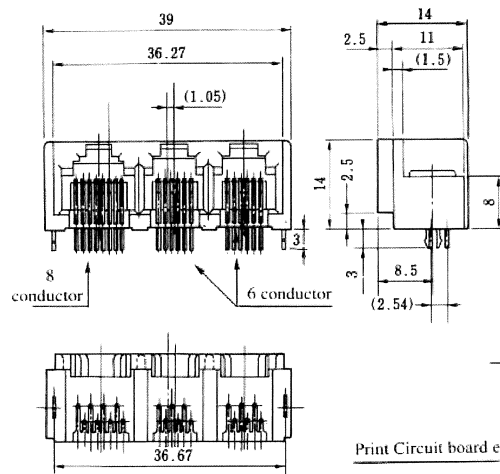
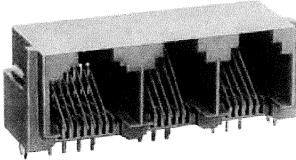

CL No.	Part No.	RoHS
222-1645-5-50	TM5RQ-2020 (50)	YES

PCB mounting hole layout
(Connector mounting side)

Note : Standard finish color is gray.

● TM5RSA-2424 (50)

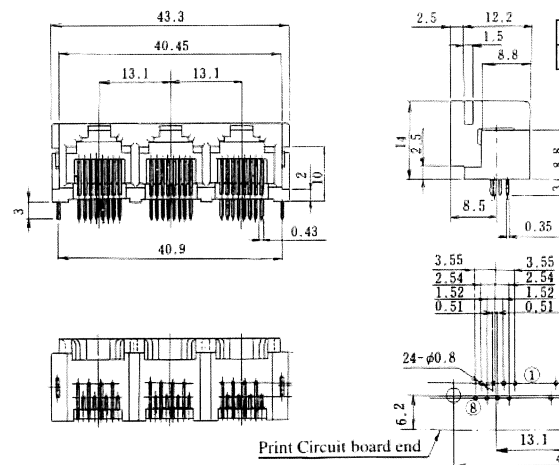
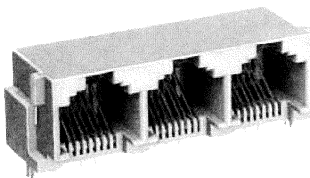

CL No.	Part No.	RoHS
222-3264-2-50	TM5RSA-2424 (50)	YES

PCB mounting hole layout (Connector mounting side)

Note : Standard finish color is gray.

The product information in this catalog is for reference only. Please request the Engineering Drawing for the most current and accurate design information.
 All non-RoHS products have been discontinued, or will be discontinued soon. Please check the products status on the Hirose website RoHS search at www.hirose-connectors.com, or contact your Hirose sales representative.

MODULAR CONNECTORS

CL 222 TM

● TM5RSB-1616 (50)

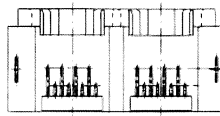
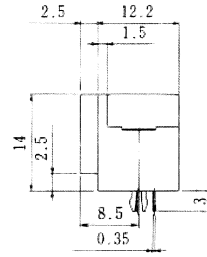
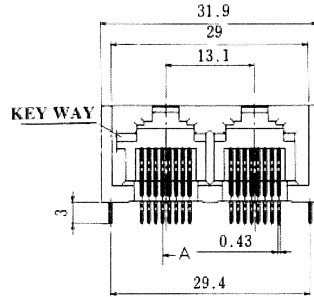
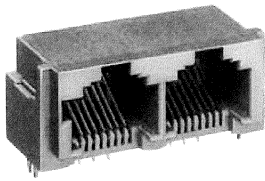

PCB mounting hole layout
(Connector mounting side)

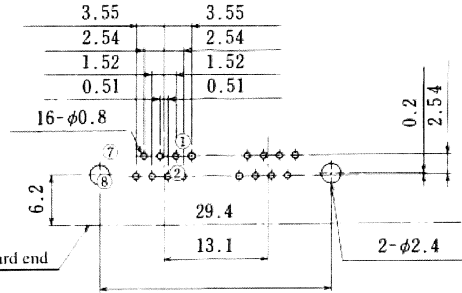

CL No.	Part No.	RoHS
222-3712-1-50	TM5RSB-1616 (50)	YES

Note : Standard finish color is gray.

● TM5RSB-2424 (50)

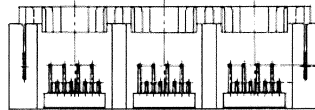
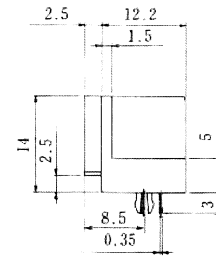
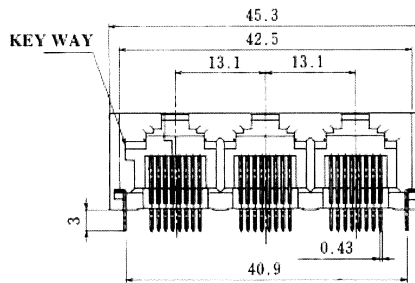
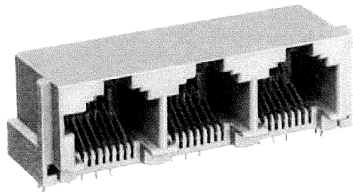

PCB mounting hole layout
(Connector mounting side)

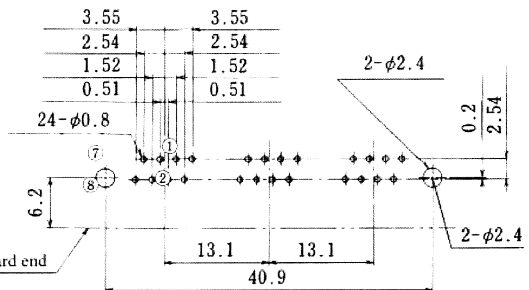

CL No.	Part No.	RoHS
222-3423-4-50	TM5RSB-2424 (50)	YES

Note : Standard finish color is gray.

EIGHT-CONDUCTOR LOW PROFILE JACKS

●GENERAL

The TM5RL Series are small 8-contact modular connectors designed to be 11.7 mm in height and 23% smaller in volume than our former models to meet the demand for smaller and thinner electronic equipment.

●FEATURES

- (1) 11.7 mm in height above PCB surface (shielded jacks: 11.9 mm)
- (2) 23% smaller in volume than our former models
- (3) Space-saving: 14 mm (14.6 mm) in width and 17 mm (7.6 mm) in depth. (): shielded jacks
- (4) EMI-protected ferrite and shielded jacks available.
- (5) Ferrite and shielded jacks use the same connector body as standard jacks, requiring no change in the PCB for redesigning.
(When you plan to redesign a standard PCB to a shielded PCB, select the shielding pattern in advance).
- (6) A quadruple jack is equal to or smaller in size than four TM5RL-88 jacks combined.
- (7) Plugs and jack connectors comply with the ISO 8877 Standard (ISDN interface connector).

●APPLICATIONS

LAN boards, HUB, ISDN terminals, and personal computers.

●RIGHT-ANGLE DIP TYPE

●TM5RL *-88(50)

CL No.	Part No.	Type	RoHS
222-2665-8-50	TM5RL-88 (50)	Standard	YES
222-2666-0-50	TM5RLF-88 (50)	With ferrite core	

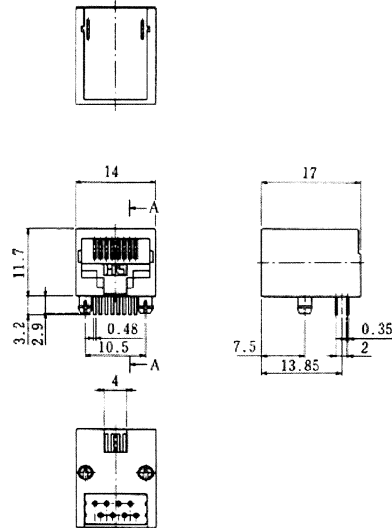
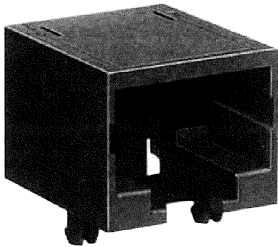

View of mating plug
A-A

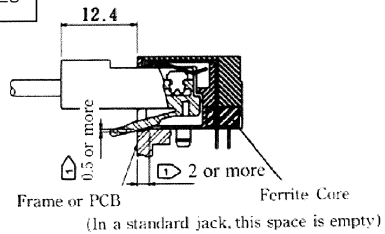

Reference mounting dimensions
(PCB component side)

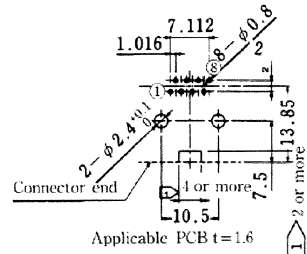

Note : When preparing frames or PCBs, follow the above \square dimensions.

MODULAR CONNECTORS

CL 222 TM

Quadruplet right-angle dip

●TM5RL *-3232(50)

CL No.	Part No.	Type	RoHS
222-2671-0-50	TM5RL-3232 (50)	Standard	YES
222-2711-3-50	TM5RLF-3232 (50)	With ferrite core	YES

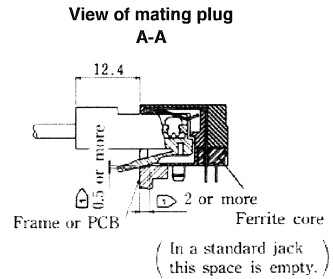
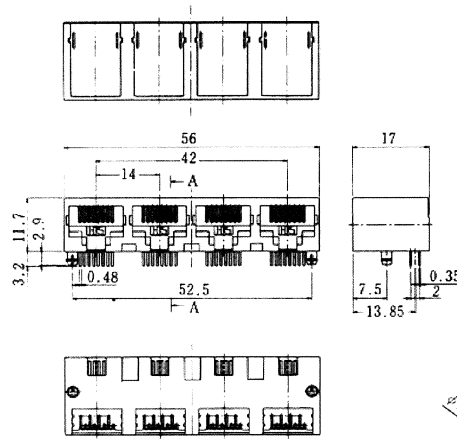
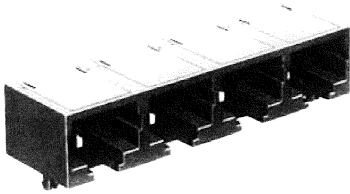

Mounting dimensions for reference (PCB mounting side)

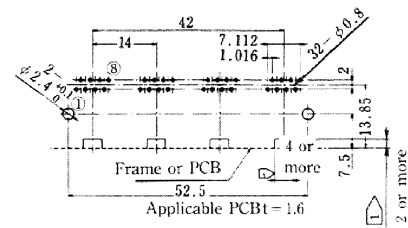

Note : When preparing frames or PCBs, provide the above \triangleright for the connector.

Eight-conductor extension adapter

●TM5RL *-88-JJ(50)

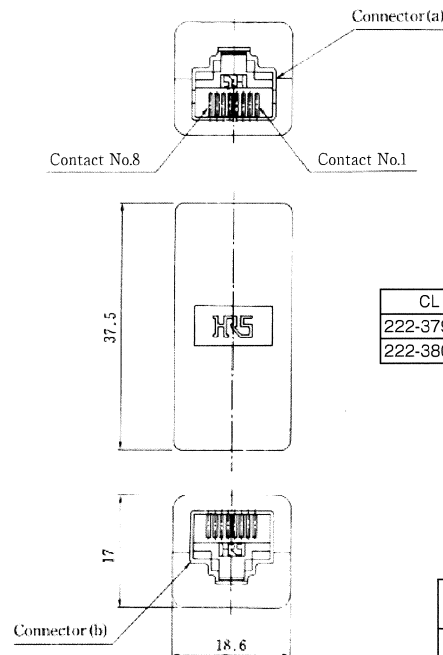
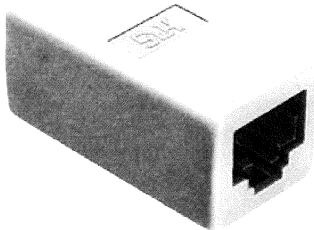

CL No.	Part No.	Type	RoHS
222-3798-7-50	TM5RL-88-JJ (50)	Standard	YES
222-3805-0-50	TM5RLF-88-JJ (50)	With ferrite core	YES

Terminal numbers

Connector(a) terminal No. TM5RL-88	1	2	3	4	5	6	7	8
Connector(b) terminal No. TM5RL-88	1	2	3	4	5	6	7	8