



UT2305

Power MOSFET

4.2A, 20V P-CHANNEL POWER MOSFET

■ DESCRIPTION

The UTC **UT2305** is P-channel enhancement mode power MOSFET, designed in serried ranks. With fast switching speed, low on-resistance, favorable stabilization.

Used in commercial and industrial surface mount applications and suited for low voltage applications such as DC/DC converters.

■ SYMBOL

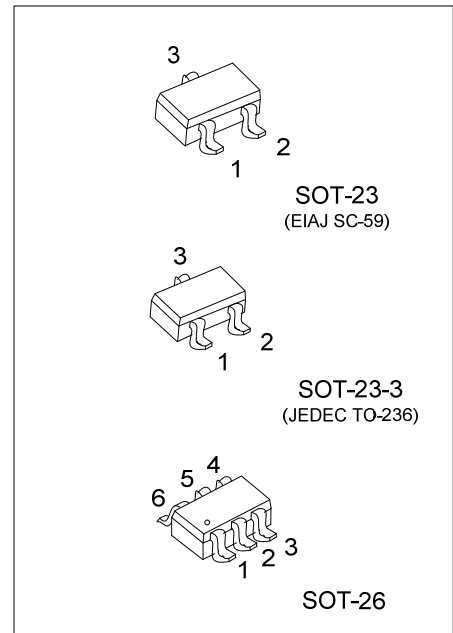
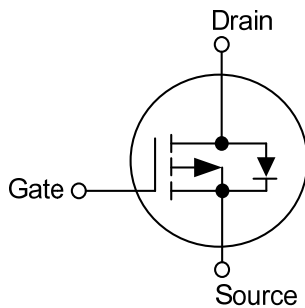

■ ORDERING INFORMATION

Ordering Number		Package	Pin Assignment						Packing
Lead Free	Halogen Free		1	2	3	4	5	6	
UT2305L-AE2-R	UT2305G-AE2-R	SOT-23-3	G	S	D	-	-	-	Tape Reel
UT2305L-AE3-R	UT2305G-AE3-R	SOT-23	G	S	D	-	-	-	Tape Reel
UT2305L-AG6-R	UT2305G-AG6-R	SOT-26	D	D	G	S	D	D	Tape Reel

Note: Pin Assignment: G: Gate S: Source D: Drain

<p>UT2305G-AE3-R</p> <p>(1)Packing Type (2)Package Type (3)Green Package</p>	<p>(1) R: Tape Reel (2) AE2: SOT-23-3, AE3: SOT-23, AG6: SOT-26 (3) G: Halogen Free and Lead Free, L: Lead Free</p>
--	---

■ MARKING

SOT-23 / SOT-23-3	SOT-26

■ ABSOLUTE MAXIMUM RATINGS

PARAMETER		SYMBOL	RATING	UNITS
Drain-Source Voltage		V_{DS}	- 20	V
Gate-Source Voltage		V_{GS}	± 12	V
Continuous Drain Current (Note 3) ($T_A=25^\circ\text{C}$)		I_D	-4.2	A
Pulsed Drain Current (Note 1, 2)		I_{DM}	-10	A
Power Dissipation ($T_A=25^\circ\text{C}$)	SOT-23-3	P_D	0.83	W
	SOT-23		1.38	W
	SOT-26		1.1	W
Junction Temperature		T_J	+150	$^\circ\text{C}$
Storage Temperature		T_{STG}	-55 ~ +150	$^\circ\text{C}$

Note: Absolute maximum ratings are those values beyond which the device could be permanently damaged. Absolute maximum ratings are stress ratings only and functional device operation is not implied.

■ THERMAL DATA

PARAMETER		SYMBOL	RATING	UNIT
Junction to Ambient (Note 3)	SOT-23-3	θ_{JA}	150	$^\circ\text{C/W}$
	SOT-23		90	$^\circ\text{C/W}$
	SOT-26		110	$^\circ\text{C/W}$

Note: Device mounted on FR-4 substrate PC board, 2oz copper, with 1inch square copper plate.

■ ELECTRICAL CHARACTERISTICS ($T_J=25^\circ\text{C}$, unless otherwise specified)

PARAMETER	SYMBOL	TEST CONDITIONS	MIN	TYP	MAX	UNIT
OFF CHARACTERISTICS						
Drain-Source Breakdown Voltage	BV_{DSS}	$V_{GS}=0V, I_D=-250\mu\text{A}$	-20			V
Drain-Source Leakage Current	I_{DSS}	$V_{DS}=-20V, V_{GS}=0V$			-1	μA
Gate-Source Leakage Current	I_{GSS}	$V_{GS}=\pm 12V, V_{DS}=0V$			± 100	nA
Breakdown Voltage Temperature Coefficient	$\Delta BV_{DSS}/\Delta T_J$	Reference to $25^\circ\text{C}, I_D=-1\text{mA}$		-0.1		$\text{V}/^\circ\text{C}$
ON CHARACTERISTICS						
Gate Threshold Voltage	$V_{GS(TH)}$	$V_{DS}=V_{GS}, I_D=-250\mu\text{A}$	-0.5		-1.2	V
Drain-Source On-State Resistance (Note 2)	$R_{DS(ON)}$	$V_{GS}=-10V, I_D=-4.5\text{A}$			53	$\text{m}\Omega$
		$V_{GS}=-4.5V, I_D=-4.2\text{A}$			65	$\text{m}\Omega$
		$V_{GS}=-2.5V, I_D=-2.0\text{A}$			100	$\text{m}\Omega$
		$V_{GS}=-1.8V, I_D=-1.0\text{A}$			250	$\text{m}\Omega$
DYNAMIC CHARACTERISTICS						
Input Capacitance	C_{ISS}	$V_{GS}=0V, V_{DS}=-15V, f=1\text{MHz}$		550		pF
Output Capacitance	C_{OSS}			108		pF
Reverse Transfer Capacitance	C_{RSS}			87		pF
SWITCHING CHARACTERISTICS						
Total Gate Charge (Note 2)	Q_G	$V_{DS}=-16V, V_{GS}=-4.5V, I_D=-4.2\text{A}$		10		nC
Gate-Source Charge	Q_{GS}			2		nC
Gate-Drain Charge	Q_{GD}			3		nC
Turn-ON Delay Time (Note 2)	$t_{D(ON)}$	$V_{DS}=-15V, V_{GS}=-10V, I_D=-1\text{A}, R_G=6\Omega, R_D=15\Omega$		4.8		ns
Turn-ON Rise Time	t_R			14.2		ns
Turn-OFF Delay Time	$t_{D(OFF)}$			36		ns
Turn-OFF Fall Time	t_F			21		ns
SOURCE- DRAIN DIODE RATINGS AND CHARACTERISTICS						
Drain-Source Diode Forward Voltage(Note2)	V_{SD}	$V_{GS}=0V, I_S=-1.2\text{A}$			-1.2	V

Notes: 1. Repetitive rating, pulse width limited by junction temperature.
2. Pulse width $\leq 300\mu\text{s}$, duty cycle $\leq 2\%$.

■ TYPICAL CHARACTERISTICS

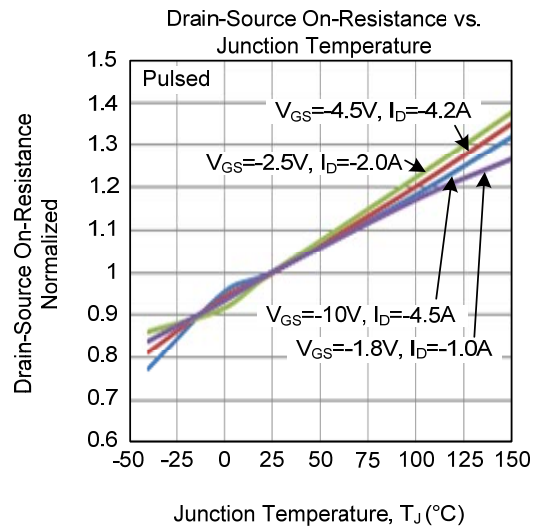
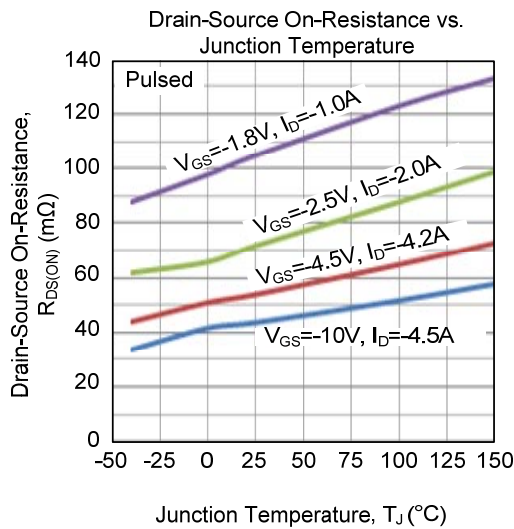
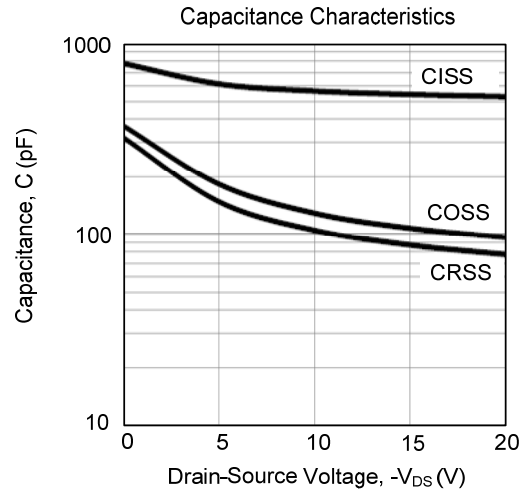
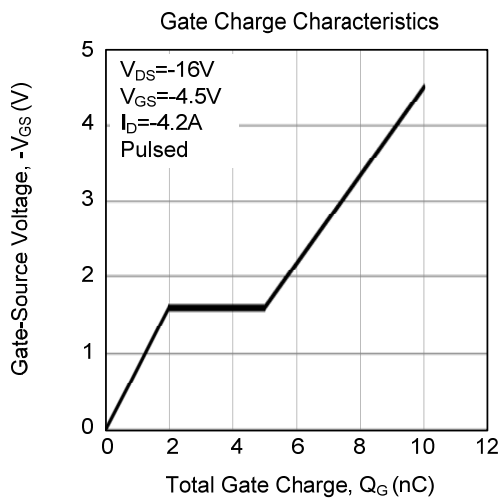
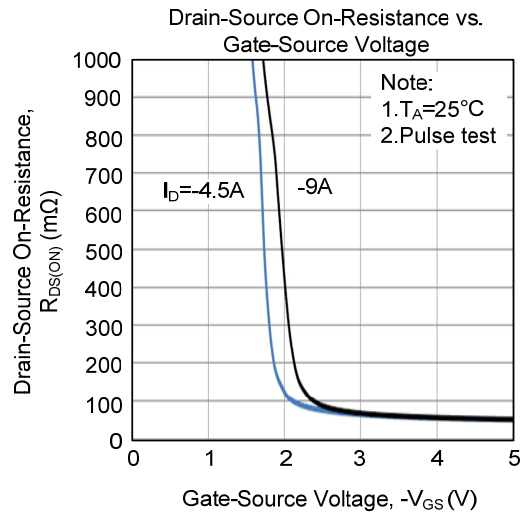
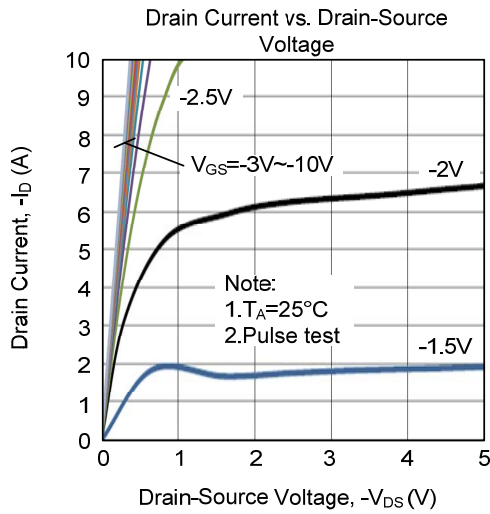

■ TYPICAL CHARACTERISTICS (Cont.)

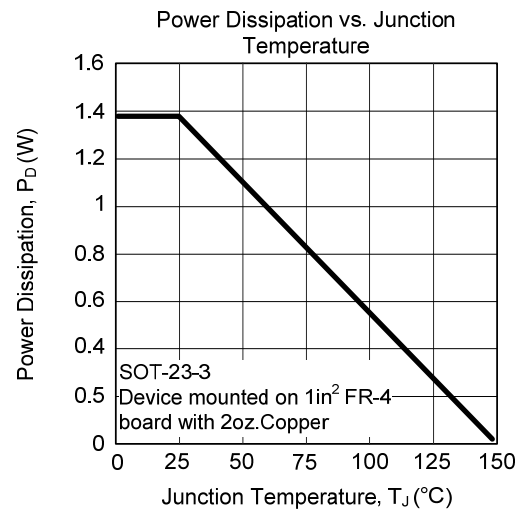
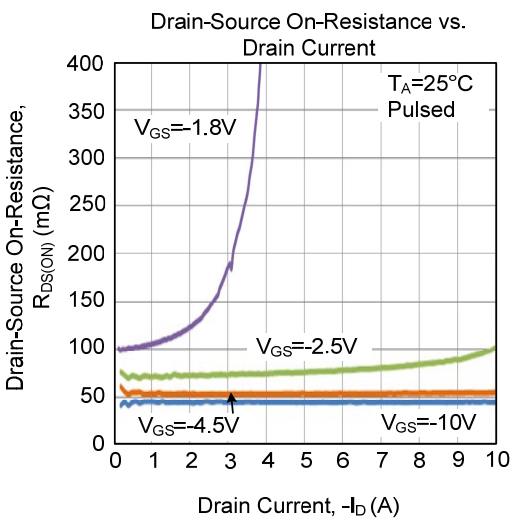
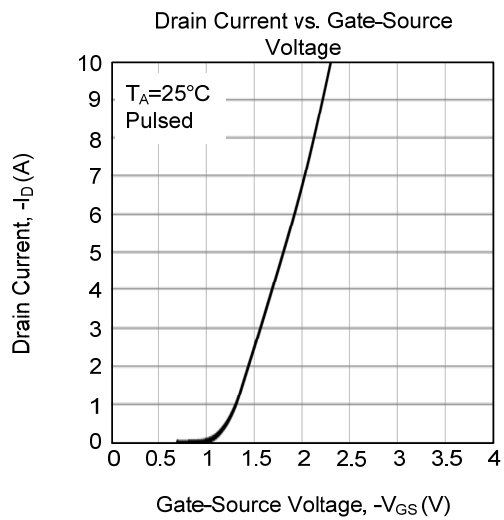
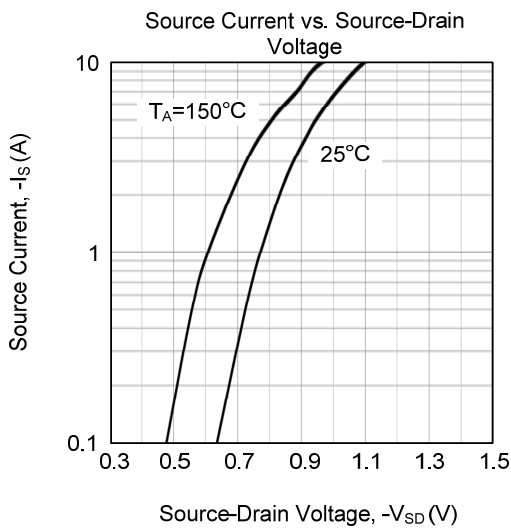
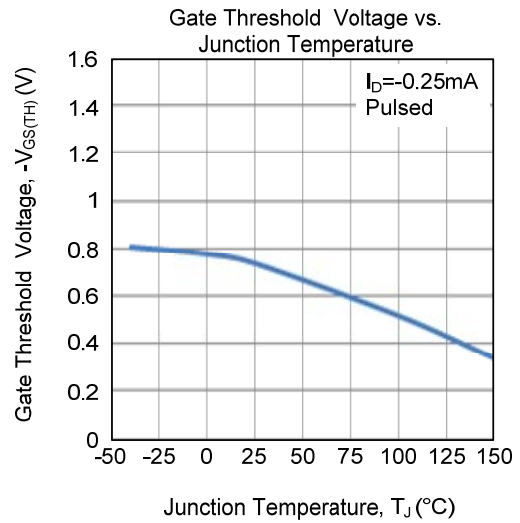
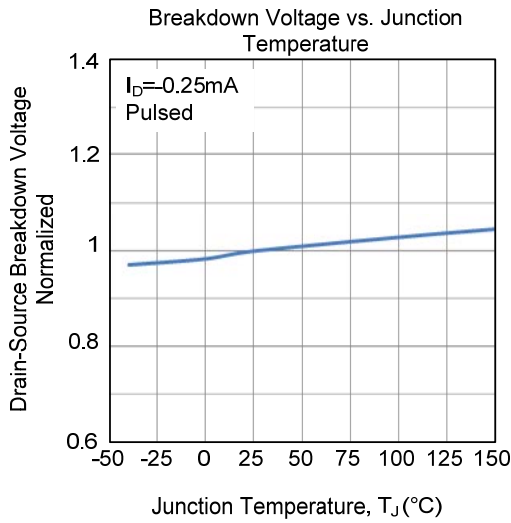

■ TYPICAL CHARACTERISTICS (Cont.)

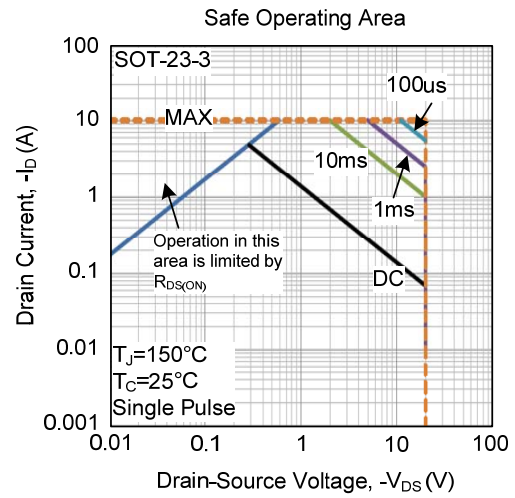
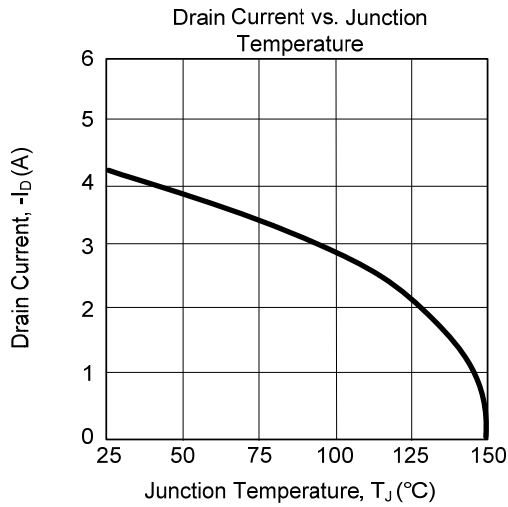

UTC assumes no responsibility for equipment failures that result from using products at values that exceed, even momentarily, rated values (such as maximum ratings, operating condition ranges, or other parameters) listed in products specifications of any and all UTC products described or contained herein. UTC products are not designed for use in life support appliances, devices or systems where malfunction of these products can be reasonably expected to result in personal injury. Reproduction in whole or in part is prohibited without the prior written consent of the copyright owner. UTC reserves the right to make changes to information published in this document, including without limitation specifications and product descriptions, at any time and without notice. This document supersedes and replaces all information supplied prior to the publication hereof.