

Chip Resistors

Product catalog

www.passivecomponent.com

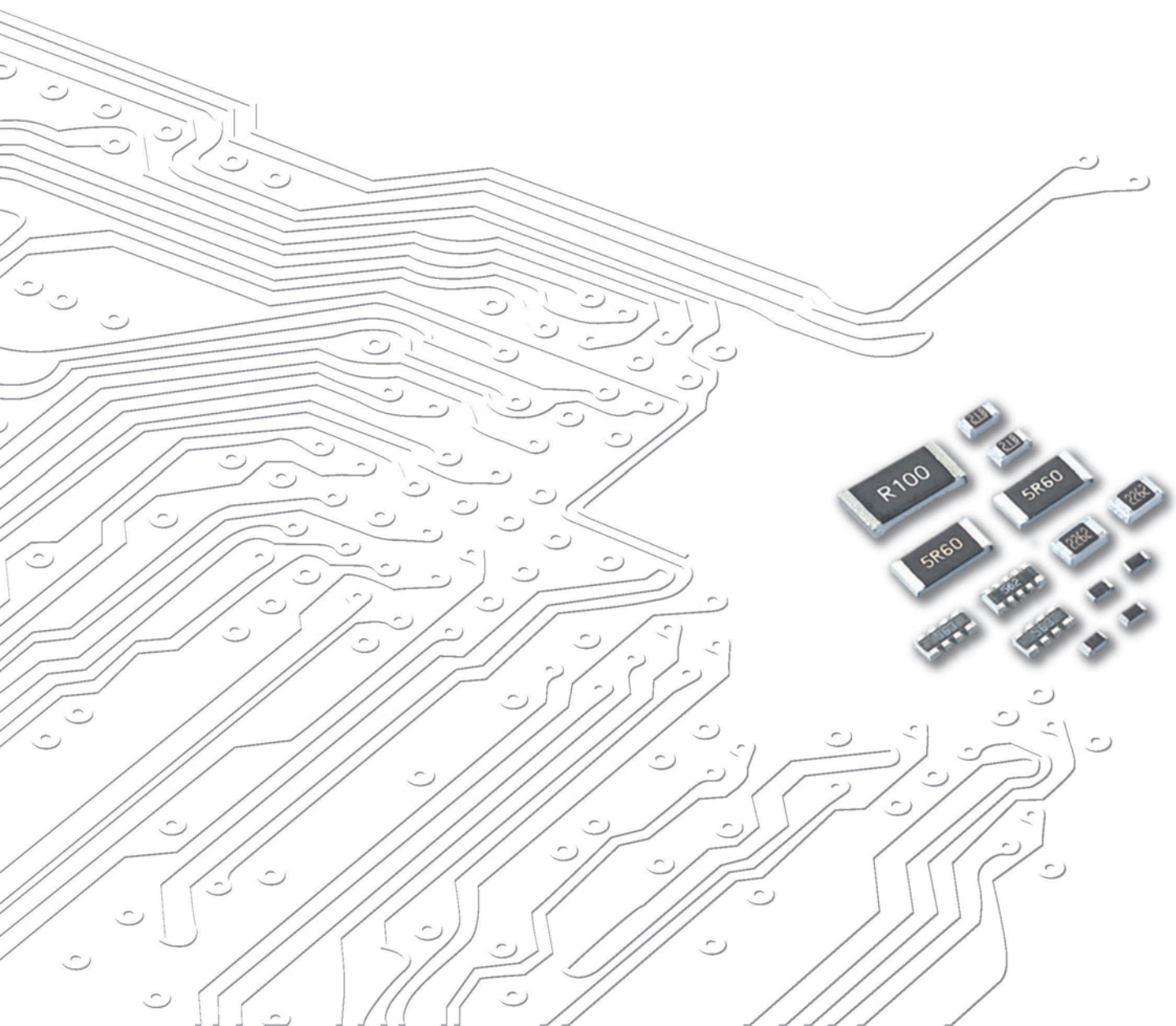

Product Portfolio



Multilayer Ceramic Capacitors (MLCC)



Chip-Resistor



Disc Capacitors



RF Device and High Frequency Inductors



Antenna



Inductors



Varistors and SMD-Varistors

IEC-63 Nominal Resistance / Capacitance

E1	100																							
E3	100				220					470														
E6	100	150	220	330	470	680																		
E12	100	120	150	180	220	270	330	390	470	560	680	820												
E24	100	110	120	130	150	160	180	200	220	240	270	300	330	360	390	430	470	510	560	620	680	750	820	910
E96	100	102	121	124	147	150	178	182	215	221	261	267	316	324	383	392	464	475	562	576	681	698	825	845
	105	107	127	130	154	158	187	191	226	232	274	280	332	340	402	412	487	499	590	604	715	732	866	887
	110	113	133	137	162	165	196	200	237	243	287	294	348	357	422	432	511	523	619	634	750	768	909	931
	115	118	140	143	169	174	205	210	249	255	301	309	365	374	442	453	536	549	649	665	787	806	953	976

E6: $\sqrt[6]{10} \approx 1.46$ E12: $\sqrt[12]{10} \approx 1.21$

E1 series resistance: 1Ω, 10Ω, 100Ω, 1000Ω, 10000Ω, 100000Ω

INDEX

Subject	Page
How to Order.....	1
Chip Resistors Selection Guide.....	3
General Purpose Chip Resistor (1Ω ~10MΩ).....	9
Thick Film Low Ohm/ Power Low Ohm Chip Resistor (0.02Ω ~ 0.976Ω)	10
Metal Low Ohm Current Sensing Chip resistor (0.001Ω ~ 0.050Ω)	11
Chip Resistor Array: Convex Termination.....	12
WA06W Chip Resistor Array 16P8R.....	13
Chip Resistor Array: Concave Termination.....	14
High Precision Thin Film Chip Resistor Array: Convex Termination.....	15
WT04X Chip Resistor Network.....	16
WA04P Chip Attenuator.....	17
Special Chip Resistor.....	18
MR/SR Series of Automotive & Anti-Sulfuration Chip Resistor.....	18
WR_R Series of Total Lead Free Chip Resistor.....	18
WKxxM Series of Trimmable Chip Resistor.....	19
WKxxV Series of High Voltage Chip Resistor.....	19
WFxxP Series of High Power Chip Resistor.....	20
WKxxS series of Surge Chip Resistors.....	20
Thick Film High Precision Chip Resistor.....	21
Thin Film Precision Chip Resistors - WF Series	21
Thin Film Professional Chip Resistors (AEC-Q200) - WF_Q Series	23
Thin Film Anti-Sulfuration (AEC-Q200) - SF_Q Series	24
Thin Film Anti-Sulfuration - SF Series	25
TaN Thin Film Chip Resistors (Auto Grade/AEC-Q200) - MF Series	26
Thin Film Low Ohmic Chip Resistor (Low TCR) - WW Series.....	26
MELF: Thin Film / Metal Film- WM Series	27
Test and Requirements.....	28
Packing on Tape and Reel.....	31
Footprint Design.....	32
Storage and Handling Condition.....	33
Recommendation of Soldering Profiles.....	33

*The specifications are subject to change or our products in it may be discontinued without advance notice. Please check with our sales representatives or product engineers before ordering.

*This catalog has only typical specifications because there is no space for detailed specifications. Therefore, please approve our product specifications or transact the approval sheet for product specifications before ordering.

■ HOW TO ORDER

Type code	Size code	Functional code	Resistance	Tolerance	Packaging code	Termination code
WR	12	X	1000	F	T	L
WR : General 1~10MR MR : Automotive SR : Anti-Sulfuration ZR : Non magnetic	25 : 2512 (6432) 20 : 2010 (5025) 18 : 1218 (3248) 12 : 1206 (3216) 10 : 1210 (3225) 08 : 0805 (2012) 06 : 0603 (1608) 04 : 0402 (1005) 02 : 0201 (0603) 01 : 01005 (0402)	X : 5% for 1 ~ 10MΩ, 1% for 10 ~ 1MΩ W : 1% for <10Ω and >1MΩ F : TC100, 1-10ohm 1% E : TC100, 100-1Mohm 5%	E24 (J tol.) E24+E96 (F tol.) *Please see remark for detail explanation	F : ± 1% J : ± 5% P : Jumper X : random	P : 4" reel taping T : 7" reel taping A : 7" reel taping 15Kpcs D : 7" reel taping 20Kpcs E : 7" up side down taping V : 7" reel taping 1Kpcs Q : 10" reel taping G : 13" reel taping H : 0402-50K/13" reel R : 0603 2mm pitch 7" reel B : Bulk C : Bulk after measuring F : 0402 1mm pitch (30k/ 7" reel) K : 10" reel taping (0402 30K/RL) J : 10" reel taping (0402 40K/RL) I : 13" up side down taping L : 01005 1mm pitch (35K/7" RL)	L= Sn base (Lead free) R= Pb ≤100ppm (total) W= Wide term. A= Anti-leaching P= 20% Pd
WW	12	M	R002	F	T	L
WW : R < 1Ω	25 : 2512 (6432) 20 : 2010 (5025) 18 : 1218 (3248) 12 : 1206 (3216) 10 : 1210 (3225) 08 : 0805 (2012) 06 : 0603 (1608) 04 : 0402 (1005)	X : Thick film low ohm (WTC) W : Thick film low TCR Hi-power Q : Metal low ohm M : Metal low ohm R : Metal low ohm high power N : Metal low ohm high power P : Thick film low TCR high Power 2512 = 2W; 2010 = 1W 1210 = 0.5W; 1206 = 0.5W C : Thick film Power low ohm low TCR, up side down D : Metal Foil E : Thick film Power low ohm A : Metal low ohm NiCu 2512 3W B : Metal low ohm MnCu 2512 3W J : Metal low ohm low EMF K : Metal low ohm low EMF L : Thick film wide term. High power T : Thick film triple power WW25T 3W	R followed by 3 significant digits e.g. : 0.1Ω = R100 0.033Ω = R033 0.56Ω = R560	F : ± 1% G : ± 2% J : ± 5%	P : 4" reel taping T : 7" reel taping Q : 10" reel taping G : 13" reel taping R : 0603 2mm pitch taping B : Bulk U : 7" reel taping (4kpcs/RL) Z : 7" reel taping (3kpcs/RL)	L= Sn base (Lead free) G= Au base S= Ag base
WK	12	T	1001	B	T	L
WF: Special Function SF: Special Function Anti-Sulfur WK: Special function Made in KM	25 : 2512 (6432) 20 : 2010 (5025) 18 : 1218 (3248) 12 : 1206 (3216) 10 : 1210 (3225) 08 : 0805 (2012) 06 : 0603 (1608) 04 : 0402 (1005)	G : High ohm (>10MΩ) H : Thick film, High Precision <1% K : Thick film, TCR50ppm M : Trimmable P : High Power S : Surge V : High voltage N : Ultra High voltage (WFxxN for UL) X : Special resistance Y : E24/E96 resistance with special Termination A : Triple Power 2512 3W	E24 (J tol.) E24+E96 (F tol.) *Please see remark for detail explanation	B : ± 0.1% C : ± 0.25% D : ± 0.5% F : ± 1% G : ± 2% J : ± 5% K : ± 10% L : ± 15% M : ± 20% P : Jumper X : 0/-30% Y : 0/-20% Z : 0/-10%	P : 4" reel taping T : 7" reel taping Q : 10" reel taping G : 13" reel taping R : 0603 2mm pitch taping B : Bulk D : 7" reel taping 20Kpcs V : 7" reel taping 1Kpcs A : 7" reel taping 15Kpcs W : 7" reel taping 2Kpcs Z : 7" reel taping (3kpcs/RL)	L= Sn base (Lead free) G= Au base S= Ag base C= Cu base D= Cu base + Low profile N= Narrow termination
WA	04	X	103_	J	T	L
WA : Array MA : Array Automotive SA : Array Anti-Sulfur TA : Thin Film Array Convex	06 : 0603 (1608) 04 : 0402 (1005) 02 : 0201 (0603)	X : *4, convex Y : *2, convex W : *8, convex T : *4, concave U : *2, concave P : *3, convex (Attenuator) A : *4, FLAT B : *2, FLAT F : *4, Reverse array G : *2, Reverse array	E24 (J tol.) E24+E96 (F tol.) **Please see remark for detail explanation	F : ± 1% J : ± 5% P : Jumper B : ± 0.1% C : ± 0.25% D : ± 0.5%	T : 7" reel taping A : 7" reel taping 15Kpcs Q : 10" reel taping G : 13" reel taping B : Bulk	L= Sn base (Lead free)
WT	04	X	103_	J	T	L
T : Network Resistors	04 : total package size 1206 (3216)	X : *8, convex	E24 (J tol.)	J : ± 5% P : Jumper	T : 7" reel taping B : Bulk	L= Sn base (Lead free)

■ HOW TO ORDER

Thin Film Series: Precision; Professional; Auto Grade Chip Resistor.

Type code	Size code	Functional code	Resistance	Tolerance	Packaging code	Termination code
WF	12	T	1001	B	T	L
WF: Thin Film Precision WF_Q: Thin Film Professional AEC-Q200 SF_Q: Thin Film Anti-Sulfuration/ AEC-Q200 SF: Thin Film Anti-Sulfuration MF: Thin Film Auto Grade AEC-Q200	25 : 2512 (6432) 20 : 2010 (5025) 12 : 1206 (3216) 10 : 1210 (3225) 08 : 0805 (2012) 06 : 0603 (1608) 04 : 0402 (1005) 02 : 0201 (0603)	T : Thin Film, TCR 50 ppm U : Thin Film, TCR 25 ppm Q : Thin Film, TCR 50 ppm, Power R : Thin Film, TCR 25 ppm, Power F : Thin Film Low TCR 15 ppm W : Thin Film Low TCR 10 ppm Z : Thin Film Extra Low TCR 5 ppm B : Thin Film Extra Low TCR 3 ppm C : Thin Film Extra Low TCR 2 ppm D : Thin Film Extra Low TCR 1 ppm * * Available Upon Request	E24+E192 **Please see remark for detail explanation	T : ± 0.01% A : ± 0.05% B : ± 0.1% C : ± 0.25% D : ± 0.5% F : ± 1%	T : 7" Reel & Taped Q : 10" Reel & Taped G : 13" Reel & Taped V : 7" Reel & Taped 1Kpcs B : Bulk	L= Sn base (Lead free)
WW	12	F	R002	F	T	L
WW : R < 1Ω (Current Sensing)	25 : 2512 (6432) 20 : 2010 (5025) 12 : 1206 (3216) 10 : 1210 (3225) 08 : 0805 (2012) 06 : 0603 (1608) 04 : 0402 (1005)	F : Thin Film TCR 75 G : Thin Film TCR 100	R followed by 3 significant digits e.g. : 0.1Ω = R100 0.033Ω = R033 0.56Ω = R560	F : ± 1% G : ± 2% J : ± 5%	P : 4" Reel & Taped T : 7" Reel & Taped Q : 10" Reel & Taped G : 13" Reel & Taped B : Bulk	L= Sn base (Lead free)
TA	04	N	1002	B	T	L
TA : Thin Film Array /Networks Convex	06 : 0603 (1608)	M : *4, Thin Film TCR 50ppm N : *4, Thin Film TCR 25ppm	E24+E192 **Please see remark for detail explanation	B : ± 0.1% C : ± 0.25% D : ± 0.5% F : ± 1%	T : 7" Reel & Taped Q : 10" Reel & Taped G : 13" Reel & Taped B : Bulk	L= Sn base (Lead free)
WM	04	C	1002	B	T	L
WM : MELF (Metal Film)	04 (0204) 07 (0207)	B : Thin Film, TCR 50 ppm C : Thin Film, TCR 25 ppm N : Thin Film, TCR 50 ppm, Power O : Thin Film, TCR 25 ppm, Power D : Thin Film Low TCR 15 ppm * * Available Upon Request	E24+E192 **Please see remark for detail explanation	B : ± 0.1% C : ± 0.25% D : ± 0.5% F : ± 1%	T : 7" Reel & Taped	L= Sn base (Lead free)

- Remark:
1. Detail product part number, functional code, tolerance combination; please refer to specific data sheet.
 2. E24 (J tol.): 2 significant digits followed by No. of zeros and a blank, e.g.: 3ohm = 3R0_, 10ohm = 100_, 220ohm = 221_, 56Kohm = 563_ ,("_" means blank).
 3. E24+E96 (F tol.): 3 significant digits followed by No. of zeros, e.g.: 3Ω = 3R00, 10Ω = 10R0, 220Ω = 2200, 56KΩ = 5602.
 4. Example: ("_" means a blank)
Chip-R 0805 size, 4.3ohm, 5%, Normal type, SnPb termination, 5000pcs taped in reel: WR08X4R3_JTL
 5. 1218 standard packing Q'ty is 3Kpcs in 10" reel and packing code is T code

■ Chip Resistor Selection Guide

■ General Purpose Chip-R

Series	Size	Rated Power	TCR (ppm/°C)*	Tolerance	Resistance
WR25X	2512 (6432)	1W	±100	±1%	1 ~ 10MΩ
			±200	±5%	
WR18X	1218 (3248)	1W	±100	±1%	
			±200	±5%	
WR20X	2010 (5025)	1/2W	±100	±1%	
			±200	±5%	
WR10X	1210 (3225)	1/3W	±100	±1%	
			±200	±5%	
WR12X	1206 (3216)	1/4W	±100	±1%	
				±5%	
WR08X	0805 (2012)	1/8W	±100	±1%	
				±5%	
WR06X	0603 (1608)	1/10W	±100	±1%	
				±5%	
WR04X	0402 (1005)	1/16W	±100	±1%	
				±5%	
WR02X	0201 (0603)	1/20W	±200	±1%	
			±200	±5%	
WR01X	01005 (0402)	1/32W	±200	±1%	4.7 ~ 1MΩ
			±200	±5%	

Remark: 1. Detailed resistance vs. TCR and ordering code please refer to specific specifications.
 2. Jumper resistor is not designed for fusing applications, designers shall apply dedicate fusible resistor or standard fuse in application circuits.
 3. WRxxW defines for ±1% < 10ohm or > 1Mohm,

■ Thick Film Low Ohm Chip-R

Series	Size	Rated Power	TCR (ppm/°C)	Tolerance	Resistance
WW25X	2512 (6432)	1W	≤ 1500**	±1%, ±5%	0.015Ω ~ 0.976Ω
WW25W			±1000**	±1%, ±5%	0.010Ω ~ 0.910Ω
WW18X	1218 (3248)	1W	≤ 1500**	±1% ±5%	0.020Ω ~ 0.976Ω 0.015Ω ~ 0.976Ω
WW20X	2010 (5025)	1/2W	≤ 1500**	±1%, ±5%	0.020Ω ~ 0.976Ω
WW20W		3/4W	±1000**	±1%, ±5%	0.010Ω ~ 0.910Ω
WW10X	1210 (3225)	1/3W	±200	±1%, ±5%	0.020Ω ~ 0.976Ω
WW10W		2/3W	±600**	±1%, ±5%	0.010Ω ~ 0.910Ω
WW12X	1206 (3216)	1/4W	≤ 1500**	±1%, ±5%	0.010Ω ~ 0.976Ω
WW12W		1/3W	±1000**	±1%, ±5%	0.010Ω ~ 0.910Ω
WW08X	0805 (2012)	1/8W	≤ 1500**	±1%, ±5%	0.020Ω ~ 0.976Ω
WW08W		1/4W	±1000**	±1%, ±5%	0.010Ω ~ 0.910Ω
WW06X	0603 (1608)	1/10W	≤ 500**	±1%, ±5%	0.100Ω ~ 0.976Ω
WW06W		1/8W	≤ 400**	±1%, ±5%	0.050Ω ~ 0.910Ω
WW04X	0402 (1005)	1/16W	≤ 600**	±1%, ±5%	0.100Ω ~ 0.976Ω

Remark: 1. Detailed resistance vs. TCR and ordering code please refer to specific specifications.
 2. Resistance value will be changed by soldering condition and design of soldering pad, please design products in consideration of this change.

■ Thick Film Power Low Ohm Chip-R

Series	Size	Rated Power	TCR (ppm/°C)	Tolerance	Resistance
WW25T	2512 (6432)	3W	100ppm	±1%, ±5%	0.100Ω ~ 0.910Ω
WW25P		2W	< 0.1Ω: 150ppm ≥ 0.1Ω: 100ppm	±1%, ±5%	0.040Ω ~ 0.976Ω
WW25W_J		2W	100 ~ 1000ppm	±1%, ±5%	0.010Ω ~ 0.910Ω
WW20P	2010 (5025)	1W	< 0.1Ω: 150ppm ≥ 0.1Ω: 100ppm	±1%, ±5%	0.040Ω ~ 0.976Ω
WW20W_H		1W	100ppm	±1%, ±5%	0.050Ω ~ 0.910Ω
WW10P	1210 (3225)	1/2W	< 0.1Ω: 500ppm ≥ 0.1Ω: 200ppm	±1%, ±5%	0.020Ω ~ 0.976Ω
WW10W_G		3/4W	100ppm	±1%, ±5%	0.050Ω ~ 0.910Ω
WW12P	1206 (3216)	1/2W	< 0.1Ω: 200ppm ≥ 0.1Ω: 100ppm	±1%, ±5%	0.020Ω ~ 0.976Ω
WW12W_G		3/4W	100 ~ 1000ppm	±1%, ±5%	0.010Ω ~ 0.910Ω
WW08P	0805 (2012)	1/3W	< 0.1Ω: 200ppm ≥ 0.1Ω: 150ppm	±1%, ±5%	0.047Ω ~ 0.976Ω
WW08W_F		1/2W	100 ~ 1000ppm	±1%, ±5%	0.010Ω ~ 0.910Ω
WW06P	0603 (1608)	1/4W	< 0.1Ω: 250ppm ≥ 0.1Ω: 200ppm	±1%, ±5%	0.047Ω ~ 0.976Ω
WW06W_D		1/4W	200 ~ 400ppm	±1%, ±5%	0.050Ω ~ 0.910Ω
WW04P	0402 (1005)	1/8W	< 0.1Ω: 300ppm ≥ 0.1Ω: 200ppm	±1%, ±5%	0.100Ω ~ 0.976Ω
WW12C	1206 (3216)	1/2W	< 0.02Ω: 150ppm ≥ 0.02Ω: 100ppm	±1%, ±5%	0.020 ~ 0.100Ω
WW08C	0805 (2012)	1/3W	< 0.03Ω: 200ppm ≥ 0.03Ω: 100ppm	±1%, ±5%	0.010 ~ 0.100Ω
WW06C	0603 (1608)	1/4W	< 0.051Ω: 0~+250ppm ≥ 0.051Ω: ±150ppm	±1%, ±5%	0.010 ~ 0.100Ω
WW04C	0402 (1005)	1/8W	< 0.051Ω: 0~+350ppm ≥ 0.051Ω: ±150ppm	±1%, ±5%	0.025 ~ 0.100Ω
WW02C	0201 (0603)	1/10W	0 ~ +500ppm	±1%, ±5%	±5%: 0.020 ~ 0.100Ω ±1%: 0.040 ~ 0.100Ω

Chip Resistors Selection Guide

■ Metal Low Ohm Sensing Type Chip-R

Series	Size	Rated Power	TCR (ppm/°C)*	Tolerance	Resistance	
WW59M	5931 (15079)	5W	±75	±1%, ±5%	2, 3, 5, 10mΩ	
WW25A	2512 (6432)	3W	±70/±50	±1%, ±5%	5.6,7,8,9,10,12,15,18,20,25,30,33,35,40, 50mΩ	
WW25B		3W	±70/±50	±1%, ±5%	3,4,5,6,7,8,9,10, 20mΩ	
WW25N		2W	±70	±1%, ±5%	3,4,5,6,7,8,9,10,12,15,20,25,30,33,35,50,80,100mΩ	
WW25K		2W	±70	±1%, ±5%	3, 4, 5, 10, 15, 20mΩ	
WW25R		2W	±70	±1%, ±5%	1, 2, 3, 4, 5, 6, 7, 8, 9, 10mΩ	
WW25M		1W	±70	±1%, ±5%	3, 4, 5, 6, 7, 8, 9, 10, 12, 15, 20, 25, 30, 33, 35, 50, 100mΩ	
WW25J		1W	±70	±1%, ±5%	3, 4, 5, 10, 15, 20mΩ	
WW25Q		1W	±70	±1%, ±5%	1, 2, 3, 4, 5, 6, 7, 8, 9, 10, 11, 12, 13, 14, 15mΩ	
WW20N		2010 (5025)	1/2W	±70	±1%, ±5%	5, 10, 15, 20, 25mΩ
WW20M			1W	±70	±1%, ±5%	5, 10, 15, 20mΩ
WW12N	1206 (3216)	1W	±70	±1%, ±5%	5, 10, 15, 20, 25, 30mΩ	
WW12K		1W	±70	±1%, ±5%	3, 4, 5, 6, 10, 15, 20, 25mΩ	
WW12R		1W	±70	±1%, ±5%	1, 2, 3, 4, 5, 6, 7, 8, 9, 10, 11, 12, 13, 14, 15mΩ	
WW12D		1W	±70	±1%, ±5%	20, 25, 30, 40, 50mΩ	
WW12M		1/2W	±70	±1%, ±5%	5, 10, 15, 20mΩ	
WW12J		1/2W	±70	±1%, ±5%	3, 4, 5, 6, 10, 15, 20, 25mΩ	
WW08D	0805 (2012)	1/2W	±70	±1%, ±5%	20, 25, 30, 40, 50mΩ	
WW08R		1/2W	±70	±1%, ±5%	2, 3, 4, 5, 6, 7, 8, 9, 10mΩ	
WW08K		1/2W	±100	±1%, ±5%	5, 6, 7, 8, 9, 10mΩ	
WW08J		1/4W	±100	±1%, ±5%	5, 6, 7, 8, 9, 10mΩ	
WW06R	0603 (1608)	1/3W	±70	±1%, ±5%	5, 10mΩ	

Remark: 1. Detailed resistance vs. TCR and ordering code please refer to specific specifications.

2. Resistance value will be changed by soldering condition and design of soldering pad, please design products in consideration of this change.

■ Chip Resistor Array

Series	Size	Rated Power	TCR (ppm/°C)	Termination	Tolerance	Resistance
WA06X	1206 (0603x4)	1/10W	±200	Convex	±1%, ±5%	10 ~ 1MΩ
WA06T	1206 (0603x4)	1/10W	±200	Concave	±1%, ±5%	
WA06Y	0606 (0603x2)	1/10W	±200	Convex	±1%, ±5%	
WA04X	0804 (0402x4)	1/16W	±200	Convex	±1%, ±5%	
WA04T	0804 (0402x4)	1/16W	±300	Concave	±1%, ±5%	
WA04F	0804 (0402x4)	1/16W	±300	Reverse Concave	±1%, ±5%	
WA04Y	0404 (0402x2)	1/16W	±200	Convex	±1%, ±5%	
WA04U	0404 (0402x2)	1/16W	±300	Concave	±1%, ±5%	
WA04G	0804 (0402x2)	1/16W	±300	Reverse Concave	±1%, ±5%	
WA06W	1606 (0402x8)	1/16W	±200	Convex	±1%, ±5%	
WA02A	0502 (0201x4)	1/32W	±200	Flat	±1%, ±5%	±5% = 10 ~ 1MΩ
WA02B	0202 (0201x2)	1/32W	±200	Flat	±1%, ±5%	±1% = 10 ~ 100KΩ
WA02F	0502 (0201x4)	1/32W	±200	Reverse Flat	±1%, ±5%	±5% = 10 ~ 1MΩ
WA02G	0202 (0201x2)	1/32W	±200	Reverse Flat	±1%, ±5%	±1% = 10 ~ 100KΩ

Remark: 1. Detailed resistance vs. TCR and ordering code please refer to specific specifications.

2. Resistance value will be changed by soldering condition and design of soldering pad, please design products in consideration of this change.

■ Chip Attenuator

Series	Size	Type	Termination	Tolerance	Attenuation	Impedance
WA04P	0404 (0402x2)	4P3R, Π type	Convex	±0.1dB ~ ±2.5dB	0, 0.5dB ~ 20dB	50Ω

■ Chip Resistor Network

Series	Size	Rated Power	TCR (ppm/°C)	Termination	Tolerance	Resistance
WT04X	1206 (10P8R)	1/16W	±200	Convex	±5%	10 ~ 100KΩ

■ High Power Chip-R

Series	Size	Rated Power	TCR (ppm/°C)	Tolerance	Resistance
WF25P	2512 (6432)	2W	±100	±1%, ±5%	Jumper; 1 ~ 1MΩ
WF20P	2010 (5025)	1W	±100		Jumper; 1 ~ 1MΩ
WF10P	1210 (3225)	1/2W	±100		Jumper; 1 ~ 1MΩ
WF12P	1206 (3216)	1/2W	±100		Jumper; 1 ~ 10MΩ
WF08P	0805 (2012)	1/4W	±100		Jumper; 1 ~ 10MΩ
WF06P	0603 (1608)	1/8W	±100		Jumper; 1 ~ 1MΩ
WF04P	0402 (1005)	1/8W	±100		Jumper; 1 ~ 1MΩ
WF25A	2512 (6432)	3W	±100		1 ~ 1MΩ
WF20A	2010 (5025)	1.5W	±100		1 ~ 1MΩ
WF10A	1210 (3225)	3/4W	±100		1 ~ 1MΩ
WF08A	0805 (2012)	1/3W	±100	1 ~ 1MΩ	
WF06A	0603 (1608)	1/4W	±100	1 ~ 1MΩ	

■ Surge Chip-R

Series	Size	Rated Power	TCR(ppm/°C)	Tolerance	Resistance	
WK25S	2512 (6432)	1W	≦ 200	±5%, ±10%, ±20%	0.27 ~ 22MΩ	
WK20S	2010 (5025)	3/4W	≦ 200		0.27 ~ 22MΩ	
WK10S	1210 (3225)	1/2W	≦ 200		0.27 ~ 22MΩ	
WK12S	1206 (3216)	1/3W	≦ 200		0.27 ~ 22MΩ	
WK08S	0805 (2012)	1/4W	≦ 200		0.27 ~ 22MΩ	
WK06S	0603 (1608)	1/4W	≦ 200		1 ~ 10MΩ	
MK08S	0805 (2012)	1/3W	≦ 100		±0.5%, ±1%, ±5%	1 ~ 1MΩ
MK06S	0603 (1608)	1/4W	≦ 100		±0.5%, ±1%, ±5%	1 ~ 1MΩ

■ Automotive Chip-R (Details please refer Automotive resistor introduction)

Series	Size	Rated Power	TCR(ppm/°C)	Tolerance	Resistance
MR25	2512 (6432)	1W	±200	±1%, ±5%	1~ 10MΩ
MR20	2010 (5025)	1/2W	±200		1~ 10MΩ
MR18	1218 (3248)	1W	±200		1~ 10MΩ
MR10	1210 (3225)	1/2W	±200		1~ 10MΩ
MR12	1206 (3216)	1/4W	±200		1~ 10MΩ
MR08	0805 (2012)	1/8W	±200		1~ 10MΩ
MR06	0603 (1608)	1/10W	±200		1~ 10MΩ
MR04	0402 (1005)	1/16W	±200		1~ 10MΩ
MR02	0201 (0603)	1/20W	±200		1~ 10MΩ

■ Anti-Sulfuration Chip-R (Details please refer Anti-sulfur resistor introduction)

Series	Size	Rated Power	TCR(ppm/°C)	Tolerance	Resistance
SR25	2512 (6432)	1W	±200	±1%, ±5%	1~ 10MΩ
SR20	2010 (5025)	1/2W	±200		1~ 10MΩ
SR12	1206 (3216)	1/4W	±200		1~ 10MΩ
SR08	0805 (2012)	1/8W	±200		1~ 10MΩ
SR06	0603 (1608)	1/10W	±200		1~ 10MΩ
SR04	0402 (1005)	1/16W	±200		1~ 10MΩ

■ High Ohm Chip-R

Series	Size	Rated Power	TCR(ppm/°C)	Tolerance	Resistance
WF12G	1206 (3216)	1/4W	≤200	±1%, ±5%	11M ~ 100MΩ
WF08G	0805 (2012)	1/8W	≤200	±1%, ±5%	11M ~ 100MΩ
WF06G	0603 (1608)	1/10W	≤200	±1%, ±5%	11M ~ 100MΩ
WF04G	0402 (1005)	1/16W	≤300	±1%, ±5%	11M ~ 30MΩ

■ High Voltage Chip-R

Series	Size	Rated Power	TCR(ppm/°C)	Voltage (V)	Tolerance	Resistance
WK25N	2512 (6432)	1W	≤200	2000	±5%, ±10%, ±20%	4.7M ~ 16MΩ
WK20N	2010 (5025)	1/2W	≤200	1500	±5%, ±10%, ±20%	1M ~ 16MΩ
WK25V	2512 (6432)	1W	≤200	800	±1%, ±5%	47~ 51MΩ
WK20V	2010 (5025)	1/2W	≤200	500	±1%, ±5%	47~ 51MΩ
WK12V	1206 (3216)	1/4W	≤200	500	±1%, ±5%	47~ 51MΩ
WK08V	0805 (2012)	1/8W	≤200	400	±1%, ±5%	47~ 51MΩ
WK06V	0603 (1608)	1/10W	≤200	200	±1%, ±5%	47~ 10MΩ
WF25N UL	2512 (6432)	1W	≤200	3000	±1%, ±5%	100K~ 100MΩ
WF20N UL	2010 (5025)	1/2W	≤200	2000	±1%, ±5%	100K~ 100MΩ
WF12N UL	1206 (3216)	1/4W	≤200	800	±1%, ±5%	100K~ 100MΩ
WF08N UL	0805 (2012)	1/8W	≤200	400	±1%, ±5%	100K~ 22MΩ
WF06N UL	0603 (1608)	1/10W	≤200	200	±1%, ±5%	100K~ 22MΩ

■ Trimmable Chip-R

Series	Size	Rated Power	TCR(ppm/°C)	Tolerance	Resistance
WK12M	1206 (3216)	1/8W	≤200	0/-20%, 0/-30%	1 ~ 4.7MΩ
WK08M	0805 (2012)	1/10W	≤200	0/-20%, 0/-30%	1 ~ 4.7MΩ
WK06M	0603 (1608)	1/16W	≤100	0/-20%, 0/-30%	10~ 4.7MΩ

■ Total lead free Chip-R (Pb < 100ppm)

Series	Size	Rated Power	TCR(ppm/°C)	Tolerance	Resistance
WR25X_R	2512 (6432)	1W	≤200	±1%, ±5%	1~ 10MΩ
WR18X_R	1218 (3248)	1W	≤200	±1%, ±5%	1~ 10MΩ
WR20X_R	2010 (5025)	1/2W	≤200	±1%, ±5%	1~ 10MΩ
WR10X_R	1210 (3225)	1/3W	≤200	±1%, ±5%	1~ 10MΩ
WR12X_R	1206 (3216)	1/4W	≤200	±1%, ±5%	1~ 10MΩ
WR08X_R	0805 (2012)	1/8W	≤200	±1%, ±5%	1~ 10MΩ
WR06X_R	0603 (1608)	1/10W	≤200	±1%, ±5%	1~ 10MΩ
WR04X_R	0402 (1005)	1/16W	≤200	±1%, ±5%	1~ 10MΩ
WR02X_R	0201 (0603)	1/20W	≤200	±1%, ±5%	1~ 10MΩ
WR01X_R	01005 (0402)	1/32W	≤200	±1%, ±5%	10~ 1MΩ
WA04X_R	0402X4	1/16W	≤200	±1%, ±5%	10 ~ 1MΩ
WA06X_R	0603x4	1/10W	≤200	±1%, ±5%	10 ~ 1MΩ

■ Thick Film High Precision Chip-R

Series	Size	Rated Power	TCR(ppm/°C)	Tolerance	Resistance
WF25H	2512 (6432)	1W	≤100	±0.1%, ±0.5%	10 ~ 1MΩ
WF20H	2010 (5025)	1/2W	≤100	±0.1%, ±0.5%	10 ~ 1MΩ
WF10H	1210 (3225)	1/3W	≤100	±0.1%, ±0.5%	10 ~ 1MΩ
WF12H	1206 (3216)	1/4W	≤100	±0.1%, ±0.5%	10 ~ 1MΩ
WF08H	0805 (2012)	1/8W	≤100	±0.1%, ±0.5%	10 ~ 1MΩ
WF06H	0603 (1608)	1/10W	≤100	±0.1%, ±0.5%	10 ~ 1MΩ
WF04H	0402 (1005)	1/16W	≤100	±0.1%, ±0.5%	10 ~ 1MΩ
WK02H	0201 (0603)	1/20W	≤200	±0.1%, ±0.5%	10 ~ 1MΩ
WF12K	1206 (3216)	1/4W	≤50	±0.1%, ±0.5%	10 ~ 1MΩ
WF08K	0805 (2012)	1/8W	≤50	±0.1%, ±0.5%	10 ~ 1MΩ
WF06K	0603 (1608)	1/10W	≤50	±0.1%, ±0.5%	10 ~ 1MΩ
WF04K	0402 (1005)	1/16W	≤50	±0.1%, ±0.5%	100 ~ 1MΩ
WK12K	1206 (3216)	1/4W	≤50	±0.1%, ±0.5%	10 ~ 1MΩ
WK08K	0805 (2012)	1/8W	≤50	±0.1%, ±0.5%	10 ~ 1MΩ
WK06K	0603 (1608)	1/10W	≤50/100	±0.1%, ±0.5%	10 ~ 1MΩ
WK04K	0402 (1005)	1/16W	≤50/100	±0.1%, ±0.5%	100 ~ 1MΩ
WK02K	0201 (0603)	1/20W	≤50/100	±0.1%, ±0.5%	10 ~ 1MΩ

■ Thin Film Precision Chip-R

Series	Size	Rated Power	TCR(ppm/°C)	Tolerance	Resistance
WF25T	2512(6432)	3/4W	±50	±0.01%, ±0.05%, ±0.10%, ±0.25%, ±0.50%, ±1.0%	4.7 ~ 3MΩ
WF25Q	2512(6432)	1W	±50	±0.01%, ±0.05%, ±0.10%, ±0.25%, ±0.50%, ±1.0%	10 ~ 1.5MΩ
WF20T	2010(5025)	1/2W	±50	±0.01%, ±0.05%, ±0.10%, ±0.25%, ±0.50%, ±1.0%	4.7 ~ 3MΩ
WF20Q	2010(5025)	3/4W	±50	±0.01%, ±0.05%, ±0.10%, ±0.25%, ±0.50%, ±1.0%	10 ~ 1.5MΩ
WF10T	1210(3225)	1/4W	±50	±0.01%, ±0.05%, ±0.10%, ±0.25%, ±0.50%, ±1.0%	4.7 ~ 2.49MΩ
WF10Q	1210(3225)	2/5W	±50	±0.01%, ±0.05%, ±0.10%, ±0.25%, ±0.50%, ±1.0%	10 ~ 1MΩ
WF12T	1206(3216)	1/8W	±50	±0.01%, ±0.05%, ±0.10%, ±0.25%, ±0.50%, ±1.0%	4.7 ~ 2.49MΩ
WF12Q	1206(3216)	1/4W	±50	±0.01%, ±0.05%, ±0.10%, ±0.25%, ±0.50%, ±1.0%	4.7 ~ 1MΩ
WF08T	0805(2012)	1/10W	±50	±0.01%, ±0.05%, ±0.10%, ±0.25%, ±0.50%, ±1.0%	4.7 ~ 2MΩ
WF08Q	0805(2012)	1/8W	±50	±0.01%, ±0.05%, ±0.10%, ±0.25%, ±0.50%, ±1.0%	4.7 ~ 1MΩ
WF06T	0603 (1608)	1/16W	±50	±0.01%, ±0.05%, ±0.10%, ±0.25%, ±0.50%, ±1.0%	4.7 ~ 1MΩ
WF06Q	0603 (1608)	1/10W	±50	±0.01%, ±0.05%, ±0.10%, ±0.25%, ±0.50%, ±1.0%	4.7 ~ 680KΩ
WF04T	0402 (1005)	1/16W	±50	±0.01%, ±0.05%, ±0.10%, ±0.25%, ±0.50%, ±1.0%	10 ~ 255KΩ
WF04Q	0402 (1005)	1/10W	±50	±0.01%, ±0.05%, ±0.10%, ±0.25%, ±0.50%, ±1.0%	10 ~ 100KΩ
WF02T	0201 (0603)	1/32W	±50	±0.1%, ±0.5%, ±1.0%	100 ~ 12KΩ
WF02Q	0201 (0603)	1/20W	±50	±0.5%, ±1.0%	27 ~ 22KΩ
WF25U	2512(6432)	3/4W	±25	±0.01%, ±0.05%, ±0.10%, ±0.25%, ±0.50%, ±1.0%	4.7 ~ 3MΩ
WF25R	2512(6432)	1W	±25	±0.01%, ±0.05%, ±0.10%, ±0.25%, ±0.50%, ±1.0%	10 ~ 1.5MΩ
WF20U	2010(5025)	1/2W	±25	±0.01%, ±0.05%, ±0.10%, ±0.25%, ±0.50%, ±1.0%	4.7 ~ 3MΩ
WF20R	2010(5025)	3/4W	±25	±0.01%, ±0.05%, ±0.10%, ±0.25%, ±0.50%, ±1.0%	10 ~ 1.5MΩ
WF10U	1210(3225)	1/4W	±25	±0.01%, ±0.05%, ±0.10%, ±0.25%, ±0.50%, ±1.0%	4.7 ~ 2.49MΩ
WF10R	1210(3225)	2/5W	±25	±0.01%, ±0.05%, ±0.10%, ±0.25%, ±0.50%, ±1.0%	10 ~ 1MΩ
WF12U	1206(3216)	1/8W	±25	±0.01%, ±0.05%, ±0.10%, ±0.25%, ±0.50%, ±1.0%	4.7 ~ 2.49MΩ
WF12R	1206(3216)	1/4W	±25	±0.01%, ±0.05%, ±0.10%, ±0.25%, ±0.50%, ±1.0%	4.7 ~ 1MΩ
WF08U	0805 (2012)	1/10W	±25	±0.01%, ±0.05%, ±0.10%, ±0.25%, ±0.50%, ±1.0%	4.7 ~ 2MΩ
WF08R	0805 (2012)	1/8W	±25	±0.01%, ±0.05%, ±0.10%, ±0.25%, ±0.50%, ±1.0%	4.7 ~ 1MΩ
WF06U	0603 (1608)	1/16W	±25	±0.01%, ±0.05%, ±0.10%, ±0.25%, ±0.50%, ±1.0%	4.7 ~ 1MΩ
WF06R	0603 (1608)	1/10W	±25	±0.01%, ±0.05%, ±0.10%, ±0.25%, ±0.50%, ±1.0%	4.7 ~ 680KΩ
WF04U	0402 (1005)	1/16W	±25	±0.01%, ±0.05%, ±0.10%, ±0.25%, ±0.50%, ±1.0%	10 ~ 255KΩ
WF04R	0402 (1005)	1/10W	±25	±0.01%, ±0.05%, ±0.10%, ±0.25%, ±0.50%, ±1.0%	10 ~ 100KΩ
WF02U	0201 (0603)	1/32W	±25	±0.1%, ±0.5%, ±1.0%	100 ~ 12KΩ
WF02R	0201 (0603)	1/20W	±25	±0.5%, ±1.0%	27 ~ 12KΩ
WF25F	2512(6432)	3/4W	±15	±0.01%, ±0.05%, ±0.10%, ±0.25%, ±0.50%, ±1.0%	4.7 ~ 1.5MΩ
WF20F	2010(5025)	1/2W	±15	±0.01%, ±0.05%, ±0.10%, ±0.25%, ±0.50%, ±1.0%	4.7 ~ 900KΩ
WF10F	1210(3225)	1/4W	±15	±0.01%, ±0.05%, ±0.10%, ±0.25%, ±0.50%, ±1.0%	4.7 ~ 400KΩ
WF12F	1206(3216)	1/4W	±15	±0.01%, ±0.05%, ±0.10%, ±0.25%, ±0.50%, ±1.0%	4.7 ~ 300KΩ
WF08F	0805(2012)	1/8W	±15	±0.01%, ±0.05%, ±0.10%, ±0.25%, ±0.50%, ±1.0%	4.7 ~ 200KΩ
WF06F	0603 (1608)	1/10W	±15	±0.01%, ±0.05%, ±0.10%, ±0.25%, ±0.50%, ±1.0%	4.7 ~ 100KΩ
WF04F	0402 (1005)	1/16W	±15	±0.01%, ±0.05%, ±0.10%, ±0.25%, ±0.50%, ±1.0%	10 ~ 20KΩ
WF25W	2512(6432)	3/4W	±10	±0.01%, ±0.05%, ±0.10%, ±0.25%, ±0.50%, ±1.0%	4.7 ~ 1.5MΩ
WF20W	2010(5025)	1/2W	±10	±0.01%, ±0.05%, ±0.10%, ±0.25%, ±0.50%, ±1.0%	4.7 ~ 900KΩ
WF10W	1210(3225)	1/4W	±10	±0.01%, ±0.05%, ±0.10%, ±0.25%, ±0.50%, ±1.0%	4.7 ~ 400KΩ
WF12W	1206(3216)	1/4W	±10	±0.01%, ±0.05%, ±0.10%, ±0.25%, ±0.50%, ±1.0%	4.7 ~ 300KΩ
WF08W	0805(2012)	1/8W	±10	±0.01%, ±0.05%, ±0.10%, ±0.25%, ±0.50%, ±1.0%	4.7 ~ 200KΩ
WF06W	0603 (1608)	1/10W	±10	±0.01%, ±0.05%, ±0.10%, ±0.25%, ±0.50%, ±1.0%	4.7 ~ 100KΩ
WF04W	0402 (1005)	1/16W	±10	±0.01%, ±0.05%, ±0.10%, ±0.25%, ±0.50%, ±1.0%	10 ~ 20KΩ
WF25Z	2512(6432)	3/4W	±5	±0.01%, ±0.05%, ±0.10%, ±0.25%, ±0.50%, ±1.0%	4.7 ~ 600KΩ
WF20Z	2010(5025)	1/2W	±5	±0.01%, ±0.05%, ±0.10%, ±0.25%, ±0.50%, ±1.0%	4.7 ~ 360KΩ
WF10Z	1210(3225)	1/4W	±5	±0.01%, ±0.05%, ±0.10%, ±0.25%, ±0.50%, ±1.0%	4.7 ~ 150KΩ
WF12Z	1206(3216)	1/4W	±5	±0.01%, ±0.05%, ±0.10%, ±0.25%, ±0.50%, ±1.0%	4.7 ~ 150KΩ
WF08Z	0805(2012)	1/8W	±5	±0.01%, ±0.05%, ±0.10%, ±0.25%, ±0.50%, ±1.0%	4.7 ~ 100KΩ
WF06Z	0603 (1608)	1/10W	±5	±0.01%, ±0.05%, ±0.10%, ±0.25%, ±0.50%, ±1.0%	4.7 ~ 50KΩ
WF04Z	0402 (1005)	1/16W	±5	±0.01%, ±0.05%, ±0.10%, ±0.25%, ±0.50%, ±1.0%	10 ~ 10KΩ
WF25B	2512(6432)	3/4W	±3	±0.01%, ±0.05%, ±0.10%, ±0.25%, ±0.50%, ±1.0%	4.7 ~ 600KΩ
WF20B	2010(5025)	1/2W	±3	±0.01%, ±0.05%, ±0.10%, ±0.25%, ±0.50%, ±1.0%	4.7 ~ 360KΩ
WF10B	1210(3225)	1/4W	±3	±0.01%, ±0.05%, ±0.10%, ±0.25%, ±0.50%, ±1.0%	4.7 ~ 150KΩ
WF12B	1206(3216)	1/4W	±3	±0.01%, ±0.05%, ±0.10%, ±0.25%, ±0.50%, ±1.0%	4.7 ~ 120KΩ
WF08B	0805(2012)	1/8W	±3	±0.01%, ±0.05%, ±0.10%, ±0.25%, ±0.50%, ±1.0%	4.7 ~ 80KΩ
WF06B	0603 (1608)	1/10W	±3	±0.01%, ±0.05%, ±0.10%, ±0.25%, ±0.50%, ±1.0%	4.7 ~ 40KΩ
WF04B	0402 (1005)	1/16W	±3	±0.01%, ±0.05%, ±0.10%, ±0.25%, ±0.50%, ±1.0%	10 ~ 8KΩ
WF25C	2512(6432)	3/4W	±2	±0.01%, ±0.05%, ±0.10%, ±0.25%, ±0.50%, ±1.0%	4.7 ~ 600KΩ
WF20C	2010(5025)	1/2W	±2	±0.01%, ±0.05%, ±0.10%, ±0.25%, ±0.50%, ±1.0%	4.7 ~ 360KΩ
WF10C	1210(3225)	1/4W	±2	±0.01%, ±0.05%, ±0.10%, ±0.25%, ±0.50%, ±1.0%	4.7 ~ 150KΩ
WF12C	1206(3216)	1/4W	±2	±0.01%, ±0.05%, ±0.10%, ±0.25%, ±0.50%, ±1.0%	4.7 ~ 120KΩ
WF08C	0805(2012)	1/8W	±2	±0.01%, ±0.05%, ±0.10%, ±0.25%, ±0.50%, ±1.0%	4.7 ~ 80KΩ
WF06C	0603 (1608)	1/10W	±2	±0.01%, ±0.05%, ±0.10%, ±0.25%, ±0.50%, ±1.0%	4.7 ~ 40KΩ
WF04C	0402 (1005)	1/16W	±2	±0.01%, ±0.05%, ±0.10%, ±0.25%, ±0.50%, ±1.0%	10 ~ 8KΩ

Thin Film TaN Automotive Chip-R (AEC-Q200)

Series	Size	Rated Power	TCR(ppm/°C)	Tolerance	Resistance
MF12R	1206(3216)	0.4W	±25	±0.05%, ±0.1%, ±0.25%, ±0.5%, ±1%	10Ω ~ 1MΩ
MF08R	0805(2012)	0.2W	±25	±0.05%, ±0.1%, ±0.25%, ±0.5%, ±1%	10Ω ~ 350KΩ
MF06R	0603(1608)	0.15W	±25	±0.05%, ±0.1%, ±0.25%, ±0.5%, ±1%	40Ω ~ 130KΩ
MF04R	0402(1005)	0.063W	±25	±0.05%, ±0.1%, ±0.25%, ±0.5%, ±1%	40Ω ~ 35KΩ
MF12Q	1206(3216)	0.4W	±50	±0.05%, ±0.1%, ±0.25%, ±0.5%, ±1%	10Ω ~ 1MΩ
MF08Q	0805(2012)	0.2W	±50	±0.05%, ±0.1%, ±0.25%, ±0.5%, ±1%	10Ω ~ 350KΩ
MF06Q	0603(1608)	0.15W	±50	±0.05%, ±0.1%, ±0.25%, ±0.5%, ±1%	40Ω ~ 130KΩ
MF04Q	0402(1005)	0.063W	±50	±0.05%, ±0.1%, ±0.25%, ±0.5%, ±1%	40Ω ~ 35KΩ

■ Thin Film Professional Chip-R (AEC-Q200)

Series	Size	Rated Power	TCR(ppm/°C)	Tolerance	Resistance
WF25U_Q	2512(6432)	3/4W	±25	±0.05%, ±0.10%, ±0.25%, ±0.50%, ±1.0%	10Ω ~ 1.5MΩ
WF25R_Q	2512(6432)	1W	±25	±0.05%, ±0.10%, ±0.25%, ±0.50%, ±1.0%	10Ω ~ 1.5MΩ
WF20U_Q	2010(5025)	1/2W	±25	±0.05%, ±0.10%, ±0.25%, ±0.50%, ±1.0%	10Ω ~ 1.5MΩ
WF20R_Q	2010(5025)	3/4W	±25	±0.05%, ±0.10%, ±0.25%, ±0.50%, ±1.0%	10Ω ~ 1.5MΩ
WF10U_Q	1210(3225)	1/4W	±25	±0.05%, ±0.10%, ±0.25%, ±0.50%, ±1.0%	10Ω ~ 1MΩ
WF10R_Q	1210(3225)	2/5W	±25	±0.05%, ±0.10%, ±0.25%, ±0.50%, ±1.0%	10Ω ~ 1MΩ
WF12U_Q	1206(3216)	1/8W	±25	±0.05%, ±0.10%, ±0.25%, ±0.50%, ±1.0%	4.7Ω ~ 1MΩ
WF12R_Q	1206(3216)	1/4W	±25	±0.05%, ±0.10%, ±0.25%, ±0.50%, ±1.0%	4.7Ω ~ 1MΩ
WF08U_Q	0805(2012)	1/10W	±25	±0.05%, ±0.10%, ±0.25%, ±0.50%, ±1.0%	4.7Ω ~ 1MΩ
WF08R_Q	0805(2012)	1/8W	±25	±0.05%, ±0.10%, ±0.25%, ±0.50%, ±1.0%	4.7Ω ~ 1MΩ
WF06U_Q	0603(1608)	1/16W	±25	±0.05%, ±0.10%, ±0.25%, ±0.50%, ±1.0%	4.7Ω ~ 680KΩ
WF06R_Q	0603(1608)	1/10W	±25	±0.05%, ±0.10%, ±0.25%, ±0.50%, ±1.0%	4.7Ω ~ 680KΩ
WF04U_Q	0402(1005)	1/16W	±25	±0.05%, ±0.10%, ±0.25%, ±0.50%, ±1.0%	10Ω ~ 100KΩ
WF04R_Q	0402(1005)	1/10W	±25	±0.05%, ±0.10%, ±0.25%, ±0.50%, ±1.0%	10Ω ~ 100KΩ
WF25F_Q	2512(6432)	3/4W	±15	±0.05%, ±0.10%, ±0.25%, ±0.50%, ±1.0%	25Ω ~ 1MΩ
WF20F_Q	2010(5025)	1/2W	±15	±0.05%, ±0.10%, ±0.25%, ±0.50%, ±1.0%	25Ω ~ 900KΩ
WF10F_Q	1210(3225)	1/4W	±15	±0.05%, ±0.10%, ±0.25%, ±0.50%, ±1.0%	25Ω ~ 400KΩ
WF12F_Q	1206(3216)	1/8W	±15	±0.05%, ±0.10%, ±0.25%, ±0.50%, ±1.0%	25Ω ~ 300KΩ
WF08F_Q	0805(2012)	1/8W	±15	±0.05%, ±0.10%, ±0.25%, ±0.50%, ±1.0%	25Ω ~ 200KΩ
WF06F_Q	0603(1608)	1/10W	±15	±0.05%, ±0.10%, ±0.25%, ±0.50%, ±1.0%	25Ω ~ 100KΩ
WF04F_Q	0402(1005)	1/16W	±15	±0.05%, ±0.10%, ±0.25%, ±0.50%, ±1.0%	25Ω ~ 20KΩ
WF25W_Q	2512(6432)	3/4W	±10	±0.05%, ±0.10%, ±0.25%, ±0.50%, ±1.0%	25Ω ~ 1MΩ
WF20W_Q	2010(5025)	1/2W	±10	±0.05%, ±0.10%, ±0.25%, ±0.50%, ±1.0%	25Ω ~ 900KΩ
WF10W_Q	1210(3225)	1/4W	±10	±0.05%, ±0.10%, ±0.25%, ±0.50%, ±1.0%	25Ω ~ 400KΩ
WF12W_Q	1206(3216)	1/8W	±10	±0.05%, ±0.10%, ±0.25%, ±0.50%, ±1.0%	25Ω ~ 300KΩ
WF08W_Q	0805(2012)	1/8W	±10	±0.05%, ±0.10%, ±0.25%, ±0.50%, ±1.0%	25Ω ~ 200KΩ
WF06W_Q	0603(1608)	1/10W	±10	±0.05%, ±0.10%, ±0.25%, ±0.50%, ±1.0%	25Ω ~ 100KΩ
WF04W_Q	0402(1005)	1/16W	±10	±0.05%, ±0.10%, ±0.25%, ±0.50%, ±1.0%	25Ω ~ 20KΩ
WF25Z_Q	2512(6432)	3/4W	±5	±0.05%, ±0.10%, ±0.25%, ±0.50%, ±1.0%	25Ω ~ 600KΩ
WF20Z_Q	2010(5025)	1/2W	±5	±0.05%, ±0.10%, ±0.25%, ±0.50%, ±1.0%	25Ω ~ 360KΩ
WF10Z_Q	1210(3225)	1/4W	±5	±0.05%, ±0.10%, ±0.25%, ±0.50%, ±1.0%	25Ω ~ 150KΩ
WF12Z_Q	1206(3216)	1/4W	±5	±0.05%, ±0.10%, ±0.25%, ±0.50%, ±1.0%	25Ω ~ 120KΩ
WF08Z_Q	0805(2012)	1/8W	±5	±0.05%, ±0.10%, ±0.25%, ±0.50%, ±1.0%	25Ω ~ 80KΩ
WF06Z_Q	0603(1608)	1/10W	±5	±0.05%, ±0.10%, ±0.25%, ±0.50%, ±1.0%	25Ω ~ 40KΩ
WF04Z_Q	0402(1005)	1/16W	±5	±0.05%, ±0.10%, ±0.25%, ±0.50%, ±1.0%	25Ω ~ 8KΩ

■ Thin Film Anti-Sulfuration Chip-R (AEC-Q200)

Series	Size	Rated Power	TCR(ppm/°C)	Tolerance	Resistance
SF25F_Q	2512(6432)	3/4W	±15	±0.05%, ±0.1%, ±0.25%, ±0.5%, ±1%	25Ω ~ 1MΩ
SF20F_Q	2010(5025)	1/2W	±15	±0.05%, ±0.1%, ±0.25%, ±0.5%, ±1%	25Ω ~ 900KΩ
SF10F_Q	1210(3225)	1/4W	±15	±0.05%, ±0.1%, ±0.25%, ±0.5%, ±1%	25Ω ~ 400KΩ
SF12F_Q	1206(3216)	1/8W	±15	±0.05%, ±0.1%, ±0.25%, ±0.5%, ±1%	25Ω ~ 300KΩ
SF08F_Q	0805(2012)	1/8W	±15	±0.05%, ±0.1%, ±0.25%, ±0.5%, ±1%	25Ω ~ 200KΩ
SF06F_Q	0603(1608)	1/10W	±15	±0.05%, ±0.1%, ±0.25%, ±0.5%, ±1%	25Ω ~ 100KΩ
SF04F_Q	0402(1005)	1/16W	±15	±0.05%, ±0.1%, ±0.25%, ±0.5%, ±1%	25Ω ~ 20KΩ
SF25R_Q	2512(6432)	1W	±25	±0.05%, ±0.1%, ±0.25%, ±0.5%, ±1%	10Ω ~ 1.5MΩ
SF20R_Q	2010(5025)	3/4W	±25	±0.05%, ±0.1%, ±0.25%, ±0.5%, ±1%	10Ω ~ 1.5MΩ
SF10R_Q	1210(3225)	2/5W	±25	±0.05%, ±0.1%, ±0.25%, ±0.5%, ±1%	10Ω ~ 1MΩ
SF12R_Q	1206(3216)	1/4W	±25	±0.05%, ±0.1%, ±0.25%, ±0.5%, ±1%	4.7Ω ~ 1MΩ
SF08R_Q	0805(2012)	1/8W	±25	±0.05%, ±0.1%, ±0.25%, ±0.5%, ±1%	4.7Ω ~ 1MΩ
SF06R_Q	0603(1608)	1/10W	±25	±0.05%, ±0.1%, ±0.25%, ±0.5%, ±1%	4.7Ω ~ 680KΩ
SF04R_Q	0402(1005)	1/10W	±25	±0.05%, ±0.1%, ±0.25%, ±0.5%, ±1%	10Ω ~ 100KΩ
SF25U_Q	2512(6432)	3/4W	±25	±0.05%, ±0.1%, ±0.25%, ±0.5%, ±1%	10Ω ~ 1.5MΩ
SF20U_Q	2010(5025)	1/2W	±25	±0.05%, ±0.1%, ±0.25%, ±0.5%, ±1%	10Ω ~ 1.5MΩ
SF10U_Q	1210(3225)	1/4W	±25	±0.05%, ±0.1%, ±0.25%, ±0.5%, ±1%	10Ω ~ 1MΩ
SF12U_Q	1206(3216)	1/8W	±25	±0.05%, ±0.1%, ±0.25%, ±0.5%, ±1%	4.7Ω ~ 1MΩ
SF08U_Q	0805(2012)	1/10W	±25	±0.05%, ±0.1%, ±0.25%, ±0.5%, ±1%	4.7Ω ~ 1MΩ
SF06U_Q	0603(1608)	1/16W	±25	±0.05%, ±0.1%, ±0.25%, ±0.5%, ±1%	4.7Ω ~ 680KΩ
SF04U_Q	0402(1005)	1/16W	±25	±0.05%, ±0.1%, ±0.25%, ±0.5%, ±1%	10Ω ~ 100KΩ
SF25W_Q	2512(6432)	3/4W	±10	±0.05%, ±0.1%, ±0.25%, ±0.5%, ±1%	25Ω ~ 1MΩ
SF20W_Q	2010(5025)	1/2W	±10	±0.05%, ±0.1%, ±0.25%, ±0.5%, ±1%	25Ω ~ 900KΩ
SF10W_Q	1210(3225)	1/4W	±10	±0.05%, ±0.1%, ±0.25%, ±0.5%, ±1%	25Ω ~ 400KΩ
SF12W_Q	1206(3216)	1/8W	±10	±0.05%, ±0.1%, ±0.25%, ±0.5%, ±1%	25Ω ~ 300KΩ
SF08W_Q	0805(2012)	1/8W	±10	±0.05%, ±0.1%, ±0.25%, ±0.5%, ±1%	25Ω ~ 200KΩ
SF06W_Q	0603(1608)	1/10W	±10	±0.05%, ±0.1%, ±0.25%, ±0.5%, ±1%	25Ω ~ 100KΩ
SF04W_Q	0402(1005)	1/16W	±10	±0.05%, ±0.1%, ±0.25%, ±0.5%, ±1%	25Ω ~ 20KΩ
SF25Z_Q	2512(6432)	3/4W	±5	±0.05%, ±0.1%, ±0.25%, ±0.5%, ±1%	25Ω ~ 600KΩ
SF20Z_Q	2010(5025)	1/2W	±5	±0.05%, ±0.1%, ±0.25%, ±0.5%, ±1%	25Ω ~ 360KΩ
SF10Z_Q	1210(3225)	1/4W	±5	±0.05%, ±0.1%, ±0.25%, ±0.5%, ±1%	25Ω ~ 150KΩ
SF12Z_Q	1206(3216)	1/4W	±5	±0.05%, ±0.1%, ±0.25%, ±0.5%, ±1%	25Ω ~ 120KΩ
SF08Z_Q	0805(2012)	1/8W	±5	±0.05%, ±0.1%, ±0.25%, ±0.5%, ±1%	25Ω ~ 80KΩ
SF06Z_Q	0603(1608)	1/10W	±5	±0.05%, ±0.1%, ±0.25%, ±0.5%, ±1%	25Ω ~ 40KΩ
SF04Z_Q	0402(1005)	1/16W	±5	±0.05%, ±0.1%, ±0.25%, ±0.5%, ±1%	25Ω ~ 8KΩ

■ Thin Film Anti-Sulfuration Chip-R

Series	Size	Rated Power	TCR(ppm/°C)	Tolerance	Resistance
SF25R	2512(6432)	1W	±25	±0.05%, ±0.1%, ±0.25%, ±0.5%, ±1%	10Ω ~ 1.5MΩ
SF20R	2010(5025)	3/4W	±25	±0.05%, ±0.1%, ±0.25%, ±0.5%, ±1%	10Ω ~ 1.5MΩ
SF10R	1210(3225)	2/5W	±25	±0.05%, ±0.1%, ±0.25%, ±0.5%, ±1%	10Ω ~ 1MΩ
SF12R	1206(3216)	1/4W	±25	±0.05%, ±0.1%, ±0.25%, ±0.5%, ±1%	4.7Ω ~ 1MΩ
SF08R	0805(2012)	1/8W	±25	±0.05%, ±0.1%, ±0.25%, ±0.5%, ±1%	4.7Ω ~ 1MΩ
SF06R	0603(1608)	1/10W	±25	±0.05%, ±0.1%, ±0.25%, ±0.5%, ±1%	4.7Ω ~ 680KΩ
SF04R	0402(1005)	1/10W	±25	±0.05%, ±0.1%, ±0.25%, ±0.5%, ±1%	10Ω ~ 100KΩ
SF25Q	2512(6432)	1W	±50	±0.05%, ±0.1%, ±0.25%, ±0.5%, ±1%	10Ω ~ 1.5MΩ
SF20Q	2010(5025)	3/4W	±50	±0.05%, ±0.1%, ±0.25%, ±0.5%, ±1%	10Ω ~ 1.5MΩ
SF10Q	1210(3225)	2/5W	±50	±0.05%, ±0.1%, ±0.25%, ±0.5%, ±1%	10Ω ~ 1MΩ
SF12Q	1206(3216)	1/4W	±50	±0.05%, ±0.1%, ±0.25%, ±0.5%, ±1%	4.7Ω ~ 1MΩ
SF08Q	0805(2012)	1/8W	±50	±0.05%, ±0.1%, ±0.25%, ±0.5%, ±1%	4.7Ω ~ 1MΩ
SF06Q	0603(1608)	1/10W	±50	±0.05%, ±0.1%, ±0.25%, ±0.5%, ±1%	4.7Ω ~ 680KΩ
SF04Q	0402(1005)	1/10W	±50	±0.05%, ±0.1%, ±0.25%, ±0.5%, ±1%	10Ω ~ 100KΩ
SF25U	2512(6432)	3/4W	±25	±0.05%, ±0.1%, ±0.25%, ±0.5%, ±1%	4.7Ω ~ 3MΩ
SF20U	2010(5025)	1/2W	±25	±0.05%, ±0.1%, ±0.25%, ±0.5%, ±1%	4.7Ω ~ 3MΩ
SF10U	1210(3225)	1/4W	±25	±0.05%, ±0.1%, ±0.25%, ±0.5%, ±1%	4.7Ω ~ 2.49MΩ
SF12U	1206(3216)	1/8W	±25	±0.05%, ±0.1%, ±0.25%, ±0.5%, ±1%	4.7Ω ~ 2.49MΩ
SF08U	0805(2012)	1/10W	±25	±0.05%, ±0.1%, ±0.25%, ±0.5%, ±1%	4.7Ω ~ 2MΩ
SF06U	0603(1608)	1/16W	±25	±0.05%, ±0.1%, ±0.25%, ±0.5%, ±1%	4.7Ω ~ 1MΩ
SF04U	0402(1005)	1/16W	±25	±0.05%, ±0.1%, ±0.25%, ±0.5%, ±1%	10Ω ~ 255KΩ
SF06W	0603(1608)	1/10W	±10	±0.05%, ±0.1%, ±0.25%, ±0.5%, ±1%	10Ω ~ 100KΩ
SF04W	0402(1005)	1/16W	±10	±0.05%, ±0.1%, ±0.25%, ±0.5%, ±1%	100Ω ~ 20KΩ
SF25T	2512(6432)	3/4W	±50	±0.05%, ±0.1%, ±0.25%, ±0.5%, ±1%	4.7Ω ~ 3MΩ
SF20T	2010(5025)	1/2W	±50	±0.05%, ±0.1%, ±0.25%, ±0.5%, ±1%	4.7Ω ~ 3MΩ
SF10T	1210(3225)	1/4W	±50	±0.05%, ±0.1%, ±0.25%, ±0.5%, ±1%	4.7Ω ~ 2.49MΩ
SF12T	1206(3216)	1/8W	±50	±0.05%, ±0.1%, ±0.25%, ±0.5%, ±1%	4.7Ω ~ 2.49MΩ
SF08T	0805(2012)	1/10W	±50	±0.05%, ±0.1%, ±0.25%, ±0.5%, ±1%	4.7Ω ~ 2MΩ
SF06T	0603(1608)	1/16W	±50	±0.05%, ±0.1%, ±0.25%, ±0.5%, ±1%	4.7Ω ~ 1MΩ
SF04T	0402(1005)	1/16W	±50	±0.05%, ±0.1%, ±0.25%, ±0.5%, ±1%	10Ω ~ 255KΩ

■ Thin Film Chip Array/Network

Series	Size	Rated Power	TCR (ppm/°C)	Termination	Tolerance	Resistance
TA06N	0603*4 (4R)	1/10W	±25	Convex	±0.1%, ±0.25%, ±0.5%, ±1.0%	47Ω ~ 200KΩ
TA06M	0603*4 (4R)	1/10W	±50	Convex	±0.1%, ±0.25%, ±0.5%, ±1.0%	47Ω ~ 200KΩ

■ Thin Film MELF

Series	Size	Rated Power	TCR(ppm/°C)	Tolerance	Resistance
WM04C	0204	0.25W	±25	±0.1%, ±0.25%, ±0.5%, ±1%	10Ω ~ 1MΩ
WM04O	0204	0.4W	±25	±0.1%, ±0.25%, ±0.5%, ±1%	10Ω ~ 1MΩ
WM04B	0204	0.25W	±50	±0.1%, ±0.25%, ±0.5%, ±1%	0.22Ω ~ 10MΩ
WM04N	0204	0.4W	±50	±0.1%, ±0.25%, ±0.5%, ±1%	0.22Ω ~ 10MΩ
WM07C	0207	0.5W	±25	±0.1%, ±0.25%, ±0.5%, ±1%	10Ω ~ 1MΩ
WM07O	0207	1W	±25	±0.1%, ±0.25%, ±0.5%, ±1%	10Ω ~ 1MΩ
WM07B	0207	0.5W	±50	±0.1%, ±0.25%, ±0.5%, ±1%	0.22Ω ~ 10MΩ
WM07N	0207	1W	±50	±0.1%, ±0.25%, ±0.5%, ±1%	0.22Ω ~ 10MΩ

■ Thin Film Low Ohm Chip-R

Series	Size	Rated Power	TCR (ppm/°C)	Tolerance	Resistance
WW25F	2512 (6432)	2W	±75	±1%, ±2%, ±5%	0.1Ω ~ 0.9Ω
WW25G			±100		0.005Ω ~ 0.9Ω
WW20F	2010 (5025)	1W	±75	±1%, ±2%, ±5%	0.1Ω ~ 0.9Ω
WW20G			±100		0.005Ω ~ 0.9Ω
WW10F	1210 (3225)	1/2W	±75	±1%, ±2%, ±5%	0.1Ω ~ 0.9Ω
WW10G			±100		0.005Ω ~ 0.9Ω
WW12F	1206 (3216)	1/2W	±75	±1%, ±2%, ±5%	0.1Ω ~ 0.9Ω
WW12G			±100		0.005Ω ~ 0.9Ω
WW08F	0805 (2012)	1/4W	±75	±1%, ±2%, ±5%	0.1Ω ~ 0.9Ω
WW08G			±100		0.005Ω ~ 0.9Ω
WW06F	0603 (1608)	1/8W	±75	±1%, ±2%, ±5%	0.1Ω ~ 0.9Ω
WW06G			±100		0.005Ω ~ 0.9Ω
WW04F	0402 (1005)	1/10W	±75	±1%, ±2%, ±5%	0.1Ω ~ 0.9Ω
WW04G			±100		0.005Ω ~ 0.9Ω

■ General Purpose Chip Resistors (1Ω~10MΩ)

■ Feature

1. High reliability and stability
2. Reduced size of final equipment
3. Lower assembly costs
4. Higher component and equipment reliability
5. RoHs compliant and lead free products

■ Application

1. Consumer electrical equipment, PDA Digital Camcorder, ...
2. EDP, Computer application
3. Mobile phone, Telecom
4. Power supply, Battery charger, DC-DC power converter
5. Digital meter
6. Automotives

■ Description

The resistors are constructed in a high grade ceramic body (aluminum oxide). Internal metal electrodes are added at each end and connected by a resistive paste that is applied to the top surface of the substrate. The composition of the paste is adjusted to give the approximate resistance required and the value is trimmed to within tolerance by laser cutting of this resistive layer.

The resistive layer is covered with a protective coat. Finally, the two external end terminations are added. For ease of soldering the outer layer of these end terminations is Tin solder (Pb free) alloy.

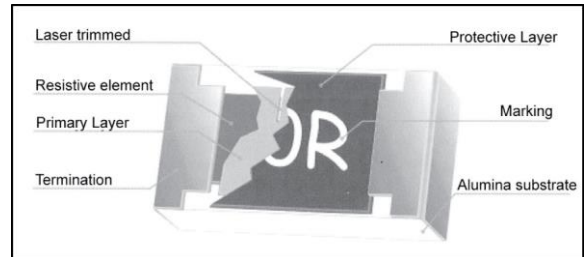

■ Quick Reference Data

Series No.	WR25X	WR20X	WR18X	WR10X	WR12X	WR08X	WR06X	WR04X	WR02X	WR01X
Size code	2512 (6432)	2010 (5025)	1218(3248)	1210 (3225)	1206 (3216)	0805(2012)	0603(1608)	0402(1005)	0201(0603)	01005(0402)
Resistance Range ±5% Tolerance (E24) ±1% Tolerance (E24+E96)	±5% (E24): 1Ω~10MΩ; Jumper ±1% (E2+E964): 1Ω~10MΩ									
TCR (ppm/°C) R>1MΩ 1MΩ≥R>10Ω R≤10Ω	≤ ±200 ≤ ±100 ≤ ±200		≤ ±200 ≤ ±100 ≤ ±200		≤ ±100 ≤ ±100 -200 ~ +400			≤ ±200 ≤ ±300		≤ ±200 ≤ ±300
Max. dissipation @ Tamb=70°C	1.0 W	1/2 W	1.0 W	1/3 W	1/4 W	1/8 W	1/10 W	1/16 W	1/20 W	1/32 W
Max. Operation Voltage (DC or RMS)	250V	200V	200V	200V	200V	150V	50V	50V	25V	20V
Operation Temperature	-55 ~ +155°C								-55 ~ +125°C	
Basic Specification	JIS C 5201-1 / IEC 60115-1									

- Note: 1. This is the maximum voltage that may be continuously supplied to the resistor element, see "IEC publication 60115-8".
 2. Max. Operation Voltage: So called RCWW (Rated Continuous Working Voltage) is determined by $RCWV = \sqrt{\text{Rated Power} \times \text{Resistance Value}}$ or Max. RCWV listed above, whichever is lower.
 3. Detailed TCR please refer to specific specification.

■ Quick Reference Data

Unit: mm

Size	2512 (6432)	2010 (5025)	1218 (3248)	1210 (3225)	1206 (3216)	0805 (2012)	0603 (1608)	0402 (1005)	0201 (0603)	01005 (0402)
L	6.40±0.20	5.00±0.20	3.05±0.15	3.10±0.10	3.10±0.10	2.00±0.10	1.60±0.10	1.00±0.05	0.60±0.03	0.40±0.02
W	3.20±0.20	2.50±0.20	4.60±0.20	2.60±0.10	1.60±0.10	1.25±0.10	0.80±0.10	0.50±0.05	0.30±0.03	0.20±0.02
T	0.60±0.10	0.55±0.10	0.55±0.10	0.55±0.10	0.60±0.15	0.50±0.15	0.45±0.15	0.35±0.05	0.23±0.03	0.13±0.02
Tb	0.90±0.25	0.60±0.25	0.50±0.25	0.50±0.20	0.45±0.20	0.40±0.20	0.30±0.15	0.25±0.10	0.15±0.05	0.10±0.03
Tt	0.65±0.25	0.65±0.25	0.45±0.25	0.50±0.20	0.50±0.20	0.40±0.20	0.30±0.10	0.20±0.10	0.10±0.05	0.08±0.03

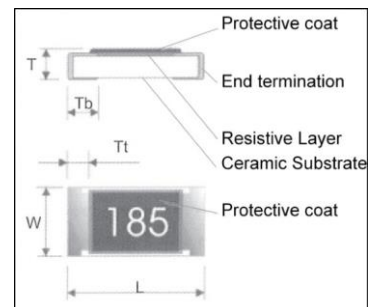

■ Power Deration Curve

For resistors operated in ambient temperature over 70°C, power rating should be derated in accordance with the following figures.

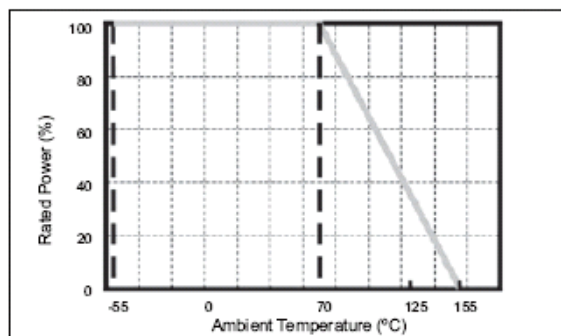

For Climatic category (IEC 60068) 55/155/56

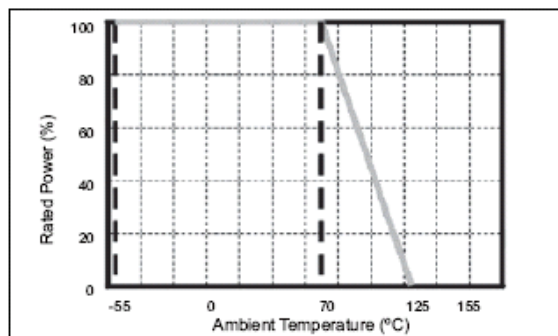

For Climatic category (IEC 60068) 55/125/56 (for 0201 type)

Thick Film Low Ohm/Power Low Ohm Chip Resistors

Function for Low Ohm Chip Resistor

The low ohmic resistors are used to sense output current in power supply, automotive and engine control management system, and other power sensing application. As shows in figure below, the typical function of low ohmic (power) chip resistor is to be a current sensor (R_{sense}) to generate the sensing voltage (V_s) for the purpose of feedback control when output current (I_o) passed on it. The sensing voltage be treated as a signal to trigger the switches (CMOS) ON/OFF duration so that to monitor and/or adjust the output current from inductor.

Simplify to say, $V_s = I_o \times R_{sense}$.

In general case, this feedback voltage is setting around 100mV for considering both on power saving and noise robustness. To sense a 5 ampere average output current, the R_{sense} resistance value therefore be required as $100mV / 5A = 20 m\Omega$, the power dissipation will be :

$$P = I^2 \times R = 5A^2 \times 20m\Omega = 0.5Watt$$

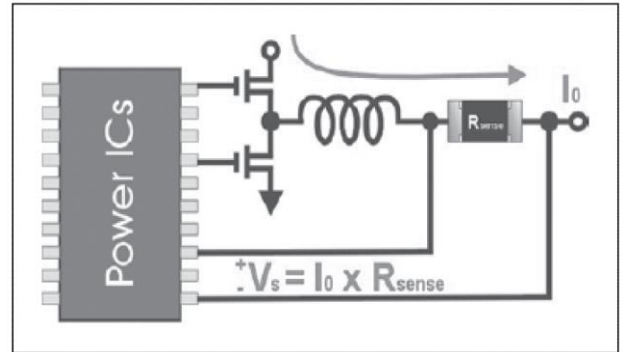

Quick Reference Data of Low Ohm Chip Resistor

Series No.	WW25X	WW20X	WW18X	WW10X	WW12X	WW08X	WW06X	WW04X
Size code	2512 (6432)	2010 (5025)	1218(3248)	1210 (3225)	1206 (3216)	0805(2012)	0603(1608)	0402(1005)
Resistance Tolerance	±5% , ±1%							
Resistance Range	0.020Ω ~ 0.976Ω						0.100Ω ~ 0.976Ω	
TCR (ppm/°C)	Detailed TCR please refer to specific data sheets							
Max. dissipation @ Tamb=70°C	1 Watt	0.5 Watt	1 Watt	1/3 Watt	1/4 Watt	1/8 Watt	1/10 Watt	1/16 Watt
Max. Operation Voltage (DC or RMS)	250V	200V	200V	200V	200V	100V	50V	50V
Operation Temperature	-55 ~ +155°C							
Basic Specification	JIS C 5201-1 / IEC 60115-1							

Note :

1. This is the maximum voltage that may be continuously supplied to the resistor element, see "IEC publication 60115-9".
2. Power derating curve, and detail specification please refer to specific data sheets.
3. Resistance value will be changed by soldering condition and design of soldering pad, please design products in consideration of change of resistance value.

Quick Reference Data of Power Low Ohm Chip Resistor

Item	General Specification					
Series No.	WW25P	WW20P	WW12P	WW08P	WW06P	WW04P
Size code	2512 (6432)	2010 (5025)	1206 (3216)	0805(2012)	0603(1608)	0402(1005)
Resistance Tolerance	±5% , ±1%					
Resistance Range	0.047Ω ~ 0.976Ω					0.1Ω~0.976Ω
TCR (ppm/°C) < 0.100Ω	±150ppm/°C	±150ppm/°C	±200ppm/°C	±200ppm/°C	±250ppm/°C	-
≥ 0.100Ω	±100ppm/°C	±100ppm/°C	±100ppm/°C	±150ppm/°C	±200ppm/°C	0~+300ppm/°C
Max. dissipation @ Tamb=70°C	2 W	1 W	1/2 W	1/3 W	1/4 W	1/8 W
Max. Operation Voltage (DC or RMS)	300V	200V	200V	150V	50V	50V
Operation Temperature	-55 ~ +155°C					

Note :

1. This is the maximum voltage that may be continuously supplied to the resistor element, see "IEC publication 60115-8".
2. Max. Operation Voltage : So called RCWV (Rated Continuous Working Voltage) is determined by $RCWV = \sqrt{\text{Rated Power} \times \text{Resistance Value}}$ or Max. RCWV listed above, whichever is lower.
3. 2W loading with total solder-pad and trace size of 300mm²

Physical Dimensions

Unit: mm

Dimensions	WW25P	WW20P	WW12P	WW08P	WW06P	WW04P
L	6.30±0.20	5.00±0.20	3.10±0.15	2.00±0.15	1.60±0.10	1.00±0.05
W	3.10±0.20	2.50±0.20	1.60±0.15	1.20±0.15	0.80±0.10	0.50±0.05
T	0.60±0.15	0.60±0.10	0.55±0.10	0.50±0.10	0.45±0.10	0.35±0.05
Tt	0.60±0.25	0.60±0.25	0.50±0.25	0.40±0.20	0.30±0.20	0.20±0.10
Tb	1.80±0.25	0.65±0.25	0.50±0.25	0.40±0.20	0.30±0.20	0.25±0.05/-0.1

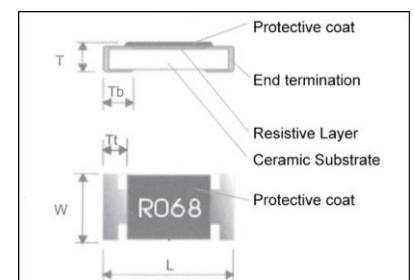

■ Metal Low Ohm Sensing Chip Resistors (0.001Ω~ 0.100Ω)

■ Description

The resistors are constructed in a high grade low resistive metal body. The resistive layer is covered with a protective coat and printed a resistance marking code over it. Finally, the two external end terminations are added. For ease of soldering, the outer layers of these end terminations are lead free terminations.

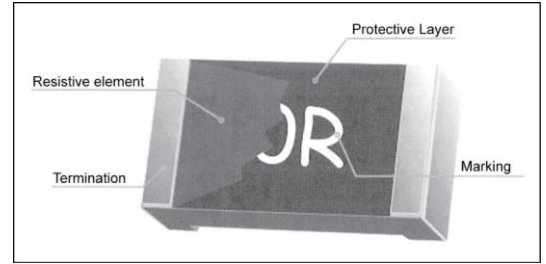

■ Quick Reference Data

Item	General Specification						
Series No.	WW25R	WW25Q	WW12R	WW12D	WW08R	WW08D	WW06R
Size code	2512 (6432)		1206(3216)		0805 (2012)	0805 (2012)	0603 (1608)
Resistance Tolerance	±5% , ±1%						
Resistance Range	1,2,3,4,5,6 .7,8,9,10mΩ	1 ~ 15mΩ	1 ~15mΩ	20, 25, 30, 40, 50mΩ	4, 5, 10mΩ	20, 25, 30, 40, 50mΩ	5, 10, 15mΩ
TCR (ppm/°C)	±100ppm		±75ppm		±75ppm	±75ppm	±75ppm
Max. dissipation @ Tamb=70°C	2 W	1 W	1 W	1 W	1/2 W	1/2 W	1/3 W
Operation Temperature	-55 ~ +155°C						

Item	General Specification					
Series No.	WW25M	WW25N	WW20M	WW20N	WW12M	WW12N
Size code	2512 (6432)		2010 (5025)		1206(3216)	
Resistance Tolerance	±5% , ±1%					
Resistance Range	3, 4, 5, 6, 7, 8, 9, 10, 12,15, 20, 25, 30, 33, 35, 50, 100mΩ	3,4,5,6,7,8,9,10, 12,15,20,25,30,33 ,35,50,80,100mΩ	5, 10, 15, 20mΩ		5, 10, 15, 20mΩ	5, 10, 15, 20, 25, 30mΩ
TCR (ppm/°C)	3mΩ: ±100ppm; > 3m: ± 75 ppm/°C		± 75 ppm/°C		± 70 ppm/°C	
Max. dissipation @ Tamb=70°C	1 W	2 W	1/2 W	1 W	1 W	1/2 W
Operation Temperature	-55 ~ +155°C					

Note :

1. This is the maximum voltage that may be continuously supplied to the resistor element, see "IEC publication 60115-8".
2. Power derating curve, and detail specification please refer to specific data sheets.
3. Resistance value will be changed by soldering condition and design of soldering pad, please design products in consideration of change of resistance value.

■ Physical Dimensions

Unit: mm

Symbol	WW25N/ WW25M	WW20N/ WW20M	WW12N/ WW12M
L	6.20±0.20	5.00±0.20	3.10±0.20
W	3.20±0.20	2.50±0.20	1.60±0.20
T	0.60±0.20	0.60±0.15	0.60±0.25
Tt	0.80±0.20	0.65±0.25	0.60±0.20
Tb	0.80±0.20	0.65±0.25	0.60±0.20

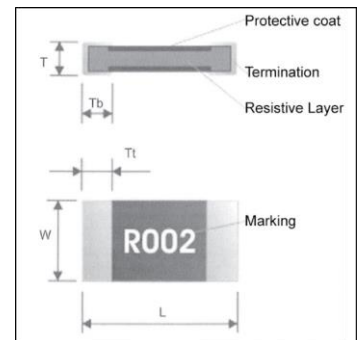

WW25Q, WW25R, WW12R, WW12D, WW06R

Note: 1. The detailed dimensions please refer to data sheet per type.

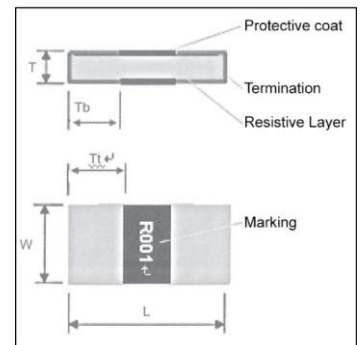

■ Chip Resistors Array : Convex Termination

■ Feature

1. High reliability and stability
2. Reduced size of final equipment
3. Lower assembly cost and higher surface mounted efficiency
4. Higher component and equipment reliability

■ Application

1. Consumer electrical equipment, PDA Digital Camcorder, ...
2. EDP, Computer application
3. Mobile phone, Telecom
4. DIMM

■ Description

The resistors array is constructed in a high grade ceramic body (aluminum oxide). Internal metal electrodes are added at each end and connected by a resistive paste that is applied to the top surface of the substrate. The composition of the paste is adjusted to give the approximate resistance required and the value is trimmed to within tolerance by laser cutting of this resistive layer.

The resistive layer is covered with a protective coat. Finally, the two external end terminations are added. For ease of soldering the outer layer of these end terminations are Tin solder alloy. Marking code description is depended on component size and tolerance. Following figure shown the construction of a Chip-R array..

■ Physical Dimensions

Unit: mm

Type	WA06X	WA04X	WA06Y	WA04Y
L	3.20±0.10	2.00±0.10	1.60±0.10	1.00±0.10
W	1.60±0.10	1.00±0.10	1.50±0.10	1.00±0.10
T	0.50±0.10	0.45±0.10	0.50±0.10	0.35±0.10
P	0.80±0.10	0.50±0.05	1.00±0.10	0.65±0.10
A	0.60±0.10	0.40±0.10	0.60±0.10	0.34±0.10
B	0.30±0.10	0.20±0.10	0.30±0.15	0.20±0.15
C	0.40±0.10	0.30±0.05	-	-
G	0.30±0.20	0.25±0.10	0.30±0.15	0.25±0.17

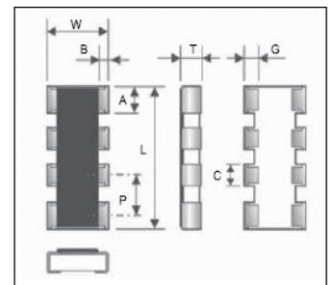
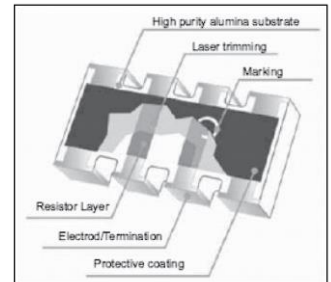

■ Quick Reference Data

Series No.	WA06X	WA04X	WA06Y	WA04Y
Size	0603x4(1608x4)	0402x4(1005x4)	0603x2(1608x4)	0402x2(1005x2)
Termination construction	8P4R,Convex		4P2R,Convex	
Resistance Tolerance	±5%, ±1% (E24 series)			
Resistance Range	10Ω~1MΩ(E24 series), Jumper (0Ω)			
TCR (ppm/°C)	±200 ppm/°C			
Max. dissipation @ Tamb=70°C	1/10 Watt	1/16 Watt	1/10 Watt	1/16 Watt
Max. Operation Voltage (DC or RMS)	50V	50V	50V	25V
Max. Overload Voltage (DC or RMS)	100V	100V	100V	50V
Operation Temperature	-55 ~ +155°C			
Basic Specification	JIS C5201-1 / IEC 60115-1			
Circuit Mode: R1=R2(=R3=R4)				

Note:

1. Power derating curve and detail specification please refer to specific data sheets.

■ WA06W Chip Resistors Array 16P8R

■ Description

The resistors array is constructed in a high grade ceramic body (aluminum oxide). Internal metal electrodes are added at each end and connected by a resistive paste that is applied to the top surface of the substrate. The composition of the paste is adjusted to give the approximate resistance required and the value is trimmed to within tolerance by laser cutting of this resistive layer.

The resistors layer is covered with a protective coat. Finally, the two external end terminations are added. For ease of soldering the outer layer of these end termination is Tin (Pb free) solder alloy.

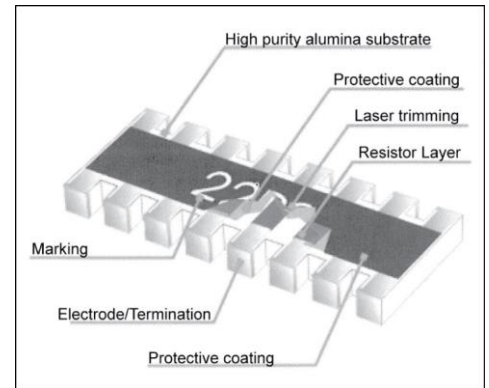

■ Quick Reference Data

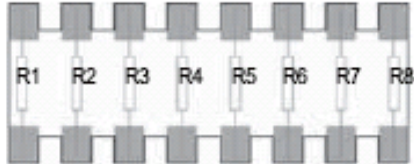
Item	General Specification	
Series No.	WA06W	WA06W_N
Size	1606 (0402x8)	1506 (0402x8)
Termination construction	Convex type	Convex type
Resistance Tolerance	±5% (E24 series)	±5% (E24 series)
Resistance Range	10Ω~100KΩ, Jumper (0Ω)	10Ω~100KΩ, Jumper (0Ω)
TCR (ppm/°C)	± 200 ppm/°C	± 200 ppm/°C
Max. dissipation @ Tamb=70°C	1/16 W	1/16 W
Max. Operation Voltage (DC or RMS)	50V	25V
Max. Overload Voltage (DC or RMS)	100V	50V
carrier Tape width	12 mm	8 mm
Operation Temperature	-55 ~ +155°C	
Circuit Mode: R1=R2=R3=R4=R5=R6=R7=R8		

Note:

1. Power derating curve and detail specification please refer to specific data sheets.

■ Physical Dimensions

Unit: mm

Symbol	WA06W	WA06W_N
L	4.00±0.20	3.80±0.10
W	1.60±0.15	1.60±0.10
T	0.45±0.10	0.45±0.10
B	0.30±0.20	0.30±0.10
G	0.30±0.20	0.30±0.10
D	0.20±0.10	0.20±0.10
P	0.50±0.20	0.50±0.10
H1	0.40±0.20	0.30±0.10
H2	0.30±0.10	0.30±0.10

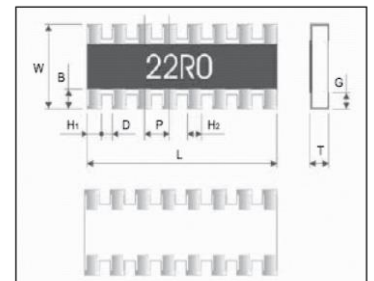

■ Chip Resistors Array : Concave Termination

■ Feature

1. High reliability and stability
2. Reduced size of final equipment
3. Lower assembly cost and higher surface mounted efficiency
4. Higher component and equipment reliability
5. Strong body and terminations
6. Excellent performance in surface mounting assembly.

■ Application

1. Consumer electrical equipment, PDA Digital Camcorder,
2. EDP, Computer application
3. Mobile phone, Telecom
4. DIMM

■ Description and Physical Dimensions

The resistor array is constructed in a high grade ceramic body (aluminum oxide). Internal metal electrodes are added at each end and connected by a resistive paste that is applied to the top surface of the substrate. The composition of the paste is adjusted to give the approximate resistance required and the value is trimmed to within tolerance by laser cutting of this resistive layer.

The resistive layer is covered with a protective coat. Finally, the two external end terminations are added. For ease of soldering the outer layer of these ends termination is Tin solder alloy. Marking code description is depended on component size and tolerance. Following figure shown the construction of a Chip-R array.

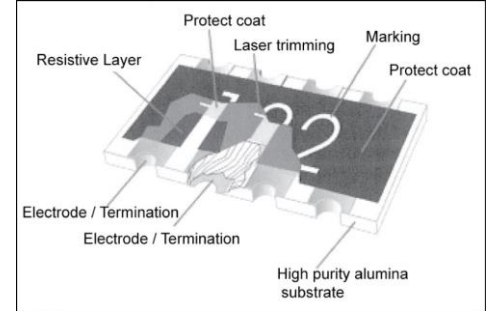

■ Quick Reference Data

Item	General Specification			
Series No.	WA06T	WA04T	WA04U	
Size	0603x4 (1608x4)	0402x4 (1005x4)	0402x2 (1005x2)	
Termination construction	Concave type			
Resistance Tolerance	±5% , ±1% (E24 series)			
Resistance Range	10Ω~1MΩ, Jumper (0Ω)			
TCR (ppm/°C)	± 200 ppm/°C	± 300 ppm/°C	± 300 ppm/°C	
Max. dissipation @ Tamb=70°C	1/10 W	1/16 W	1/16 W	
Max. Operation Voltage (DC or RMS)	50V	25V	25V	
Max. Overload Voltage	100V	50V	50V	
Operation Temperature	-55 ~ +155°C			
Circuit Mode	 R1=R2=R3=R4		 R1 = R2	
	L	3.20+0.20/-0.10mm	2.00±0.10mm	1.00±0.10mm
	W	1.60+0.20/-0.10mm	1.00±0.10mm	1.00±0.10mm
	T	0.60±0.20mm	0.45±0.10mm	0.30±0.10mm
	P	0.80±0.10mm	0.50±0.05mm	0.50±0.05mm
	A	0.60±0.15mm	0.35±0.05mm	0.35±0.10mm
	B	0.35±0.15mm	0.20±0.15mm	0.25±0.15mm
	C	0.50±0.15mm	0.25±0.05mm	0.35±0.10mm
	G	0.50±0.15mm	0.25±0.15mm	0.25±0.15mm

Note:

1. Power derating curve and detail specification please refer to specific data sheets.
2. Max. Operation Voltage: So called RCWW (Rated Continuous Working Voltage) is determined by

$$RCWW = \sqrt{\text{Rated Power} \times \text{Resistance Value}}$$
 or Max. RCWW listed above, whichever is lower.

■ High Precision Thin Film Chip Resistors Array : Convex Termination

■ Feature

- 1.SMD metal film resistor
2. High reliability and stability 0.1% and below
3. High performance of TCR 25ppm and below
4. Low current noise.

■ Application

1. Medical equipment
2. Measuring instrument
3. Communication device
4. Computer.

■ Description

The resistors array is constructed in a high grade ceramic body (aluminum oxide). Internal metal electrodes are added at each end and connected by a resistive paste that is applied to the top surface of the substrate.

The composition of the paste is adjusted to give the approximate resistance required and the value is trimmed to within tolerance by laser cutting of this resistive layer. The resistive layer is covered with a protective coat.

Finally, the two external end terminations are added. For ease of soldering the outer layer of these end terminations are Tin solder alloy. Marking code description is depended on component size and tolerance. Following figure shown the construction of a Chip-R array.

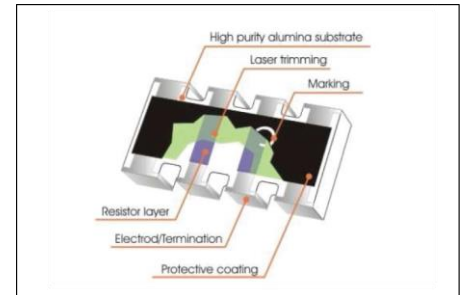

■ Physical Dimensions

Unit: mm

Type	TA06N/TA06M	TA02R/TA02Q
W	1.50±0.15	0.55±0.10
L	3.20±0.15	0.80±0.10
P	0.80±0.10	0.45±0.10
C	0.40±0.10	0.15±0.10
A	0.60±0.10	0.30±0.10
B	0.30±0.15	-
G	0.25±0.15	-
T	0.45±0.10	0.35±0.10

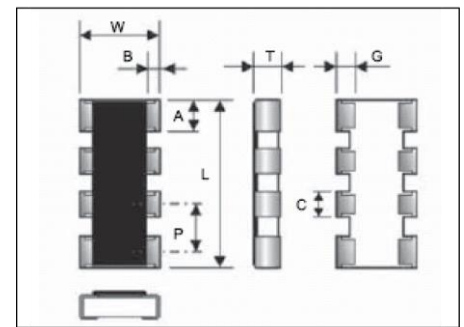

■ Quick Reference Data

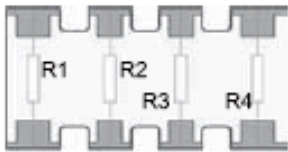
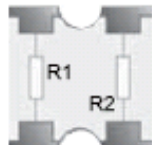
Series No.	TA06N	TA06M	TA02R	TA02Q
Size	0603×4(1608×4)		0201×2(0603×2)	
Termination construction	8P4R,Convex		4P2R,Convex	
Resistance Tolerance	±1%, ±0.5%,±0.25%, ±0.1% (E24+E96 series)		±0.5% , ±0.1% (E24+E96 series)	
Resistance Range	47Ω~200KΩ		10 ~ 10KΩ	
TCR (ppm/°C)	±25 ppm/°C	±50 ppm/°C	±25 ppm/°C	±50 ppm/°C
Max. dissipation @ Tamb=70°C	1/10 Watt	1/10 Watt	1/10 Watt	1/16 Watt
Max. Operation Voltage (DC or RMS)	75V	75V	50V	25V
Max. Overload Voltage (DC or RMS)	150V	150V	100V	50V
Operation Temperature	-55 ~ +155°C			
Basic Specification	JIS C5201-1 / IEC 60115-8			
Circuit Mode: R1=R2(=R3=R4)				

Note:

1. Power derating curve and detail specification please refer to specific data sheets.

■ WT04X Chip Resistor Network 10P8R

■ Description

The resistor array is constructed in a high grade ceramic body (aluminum oxide). Internal metal electrodes are added at each end and connected by a resistive paste that is applied to the top surface of the substrate. The composition of the paste is adjusted to give the approximate resistance required and the value is trimmed to within tolerance by laser cutting of this resistive layer.

The resistive layer is covered with a protective coat. Finally, the two external end terminations are added. For ease of soldering the outer layer of these end termination is Tin (Pb free) solder alloy.

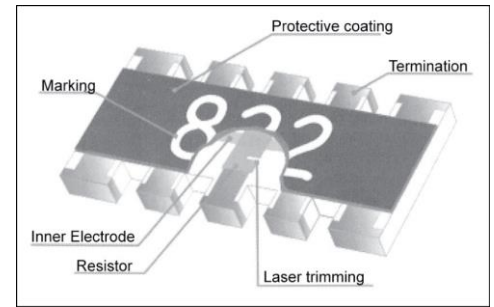

■ Quick Reference Data

Item	General Specification
Series No.	WT04X
Size	0402x8 (1005x8)
Termination construction	Convex type
Resistance Tolerance	±5% (E24 series)
Resistance Range	10Ω ~ 100KΩ
TCR (ppm/°C)	± 200 ppm/°C
Max. dissipation @ Tamb=70°C	1/16 W
Max. Operation Voltage (DC or RMS)	25V
Max. Overload Voltage (DC or RMS)	50V
Operation Temperature	-55 ~ +155°C
Circuit Mode: Resistor elements on pin1 ~ pin4, pin6 ~ pin9; R1=R2=R3=R4=R6=R7=R8=R9	

Note:

1. Power derating curve and detail specification please refer to specific data sheets.

■ Physical Dimensions

Unit: mm

Symbol	
L	3.30±0.20
W	1.60±0.15
T	0.55±0.10
P	0.64±0.05
A	0.50±0.05
B	0.40±0.15
C	0.40±0.15
G	0.40±0.15

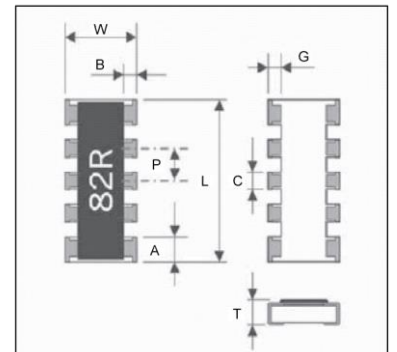

■ WA04P Chip Attenuator

■ Typical Application of Chip Attenuator

WA04	P	001	X	B	T	L
Size code	Type code	Attenuation Range	Characteristic Impedance	Attenuation Tolerance	Termination	Packaging
WA04: 0402 per element	P:convex, p type attenuator	000 = 0dB R05 = 0.5dB 001 = 1dB R15 = 1.5dB 002 = 2dB 003 = 3dB 004 = 4dB 005 = 5dB 006 = 6dB 007 = 7dB 008 = 8dB 009 = 9dB 010 = 10dB 011 = 11dB 012 = 12dB 013 = 13dB 014 = 14dB 015 = 15dB 016 = 16dB 017 = 17dB 018 = 18dB 019 = 19dB 020 = 20dB	X:50Ω	A : ± 0.1dB B : ± 0.3dB C : ± 0.4dB D : ± 0.8dB E : ± 1.0dB F : ± 1.5dB G : ± 2.0dB H : ± 2.5dB P : -	T=7" reel taped	L=Sn base (lead free)

π type Attenuator for VSWR improvement and output frequency level matching on VCO application.

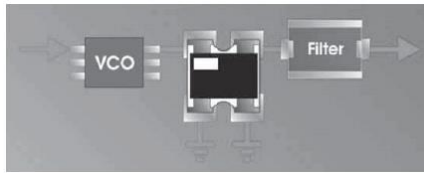

■ Quick Reference Data

Item	General Specification
Series No.	WA04P
Size	0402x2 (1005x2)
Termination construction	Convex type
Attenuation Range	0dB, 0.5dB ~ 20dB
Attenuation Tolerance	
0dB	-
0.5 dB	±0.1dB
1dB ~ 5dB	±0.3dB
6dB ~ 10dB	±0.4dB
11dB ~ 13dB	±0.8dB
14dB	±1.0dB
15 ~ 16dB	±1.5dB
17 ~ 19dB	±2.0dB
20dB	±2.5dB
Characteristic impedance	50Ω
Rated power at Tamb=70°C	0.1 W / package
Limiting Voltage (DC)	50V
Frequency range (DC)	MAX. 3 GHz
VSWR (Voltage Standing Wave Ratio)	MAX. 1.2
Number of Resistors	3 resistors
Number of Terminals	4 terminals
Operation Temperature	-40 ~ +125°C

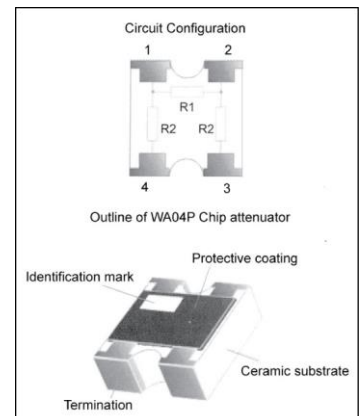
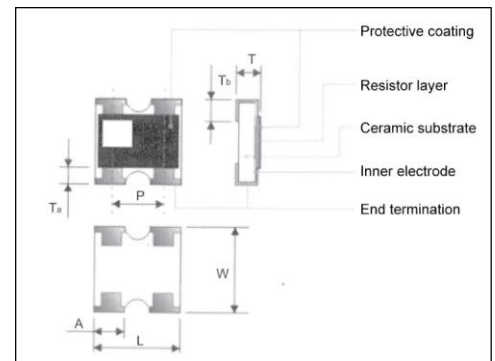

■ Physical Dimensions

Unit: mm

	WA04P
L	1.00±0.10
W	1.00+0.10/-0
T	0.35±0.10
P	0.65±0.20
A	0.33±0.10
Ta	0.15±0.10
Tb	0.25±0.10

■ Special Application Chip Resistors

■ Feature

1. Provided Automotive & Anti-sulfuration resistors (MR/SR series) for Auto & Anti-sulfuration application.
2. Provided Total Lead Free resistors (WR_R series) to fulfill RoHS environmental regulation.
3. Provided trimmable resistors (WKxxM series) for customer special tolerance requirement.
4. Provided high precision tolerance (WFxxH/ WFxxT/ WFxxU/ WFxxW) down to $\pm 0.05\%$ and TCR down to 10ppm/°C for voltage sensing application.
5. High reliability and stability.
6. Reduced size of final equipment
7. Lower assembly costs.
8. Higher component and equipment reliability
9. Special resistance, tolerance are available upon customer's request.

■ MR/SR Series of Automotive & Anti-sulfuration Chip Resistor

■ Feature

1. High reliability and stability $\pm 1\%$.
2. Sulfuration resistant
3. Automotive grade AEC Q-200 compliant.
4. 100% CCD inspection.
5. RoHS compliant and lead free.

■ Application

1. Automotive application.
2. Consumer electrical equipment.
3. EDP, Computer application.
4. Telecom Application.

■ Quick Reference Data

Series No.	MR25X	MR20X	MR18X	MR10X	MR12X	MR08X	MR06X	MR04X
Size code	2512(6432)	2010(5025)	1218(3248)	1210(3225)	1206(3126)	0805(2012)	0603(1608)	0402(1005)
Resistance Range	1Ω~10MΩ ($\pm 1\%$, $\pm 5\%$), Jumper				1Ω~10MΩ ($\pm 1\%$, $\pm 5\%$), Jumper			
TCR (ppm/°C)	± 200 ppm*				± 200 ppm*			
Max. dissipation @ Tamb=70°C	1 W	1/2 W	1 W	1/2 W	1/4 W	1/8 W	1/10 W	1/16 W
Max. Operation Voltage	250V	200V	200V	200V	200V	150V	75V	50V
Operation Temperature	-55 ~ +155°C				-55 ~ +155°C			

Series No.	SR25X	SR20X	SR12X	SR08X	SR06X	SR04X
Size code	2512(6432)	2010(5025)	1206(3126)	0805(2012)	0603(1608)	0402(1005)
Resistance Range	1Ω~10MΩ ($\pm 1\%$, $\pm 5\%$), Jumper					
TCR (ppm/°C)	± 200 ppm*					
Max. dissipation @ Tamb=70°C	1 W	1/2 W	1/4 W	1/8 W	1/10 W	1/16 W
Max. Operation Voltage	250V	200V	200V	150V	75V	50V
Operation Temperature	-55 ~ +155°C					

Remark: *Detail specification please refers to specific data sheets. *MR series can withstand H2S 3ppm×1000hrs. *SR series can withstand H2S 1000ppm×720hrs.

■ WR_R Series of Total Lead Free Chip Resistor

■ Feature

1. High reliability and stability
2. Reduced size of final equipment
3. Lower assembly cost
4. Higher component and equipment reliability
5. RoHS compliant and total lead free.

■ Quick Reference Data

Series No.	WR10_R	WR12_R	WR08_R	WR06_R	WR04_R	WR02_R
Size code	1210 (3225)	1206 (3216)	0805 (2012)	0603 (1608)	0402 (1005)	0201 (0603)
Resistance Range	1Ω~10MΩ ($\pm 1\%$, $\pm 5\%$), Jumper					
TCR (ppm/°C)	± 200 ppm*					
Max. dissipation @ Tamb=70°C	1/3 W	1/4 W	1/8 W	1/10 W	1/16 W	1/20 W
Max. Operation Voltage (DC or RMS)	200V	200V	150V	50V	50V	25V
Operation Temperature	-55 ~ +155°C					-55 ~ +125°C

Remark: *Detail specification please refers to specific data sheets.

■ Part No. Definition

1 st code	2 nd code	3 rd - 4 th code	5 th code	6 th - 9 th code	10 th code	11 th code	12 th code
□	□	□□	□	□□□□	□	□	<u>R</u>
WTC	Type code	Size code	Functional code	Marking code (Resistance)	Tolerance code	Packaging code	Termination code
For example:							
W	R	04	X	1000	F	T	R

■ WKxxM Series of Trimmable Chip Resistor

■ Feature

1. High precision, reliability and stability
2. Miniature size down to 0603 (1608)

■ Application

1. Automotive application.
2. Consumer electrical equipment.
3. EDP, Computer application.
4. Telecom Application.

■ Description

The resistors are constructed on a high grade ceramic body (aluminum oxide). Internal metal electrodes are added at each end and connected by a resistive paste that is applied to the top surface of the substrate. The composition of the paste is adjusted to give the approximate resistance required.

The resistive layer is covered with a transparent protective coat. Finally, the two external end terminations are added. For ease of soldering the outer layer of these end termination is Tin (Pb free) solder alloy.

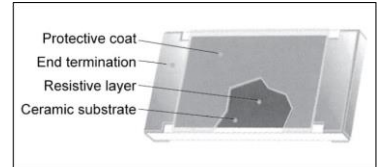

■ Physical Dimensions

Unit: mm

Type	WK25M	WK20M	WK10M	WK12M	WK08M	WK06M
L	6.30±0.15	5.00±0.15	3.10±0.15	3.10±0.15	2.00±0.10	1.60±0.10
W	3.20±0.15	2.50±0.15	2.50±0.15	1.60±0.15	1.25±0.10	0.80+0.15/-0.10
T	0.55±0.15	0.55±0.15	0.55±0.15	0.55±0.10	0.55±0.10	0.45±0.10
Tb	0.60±0.20	0.60±0.20	0.50±0.25	0.50±0.25	0.40±0.20	0.30±0.10
Tt	0.60±0.20	0.60±0.20	0.50±0.25	0.50±0.25	0.40±0.20	0.30±0.10

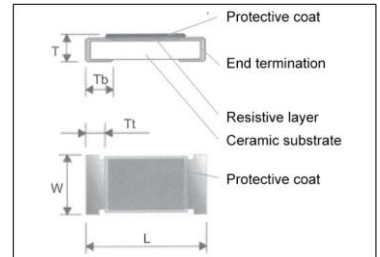

■ Quick Reference Data

Series No.	WK25M	WK20M	WK10M	WK12M	WK08M	WK06M
Size code	2512 (6332)	2010 (5025)	1210(3225)	1206(3216)	0805(2012)	0603(1608)
Resistance Tolerance	0/-20%(Y) and 0/-30%(X) E24 series					
Resistance Range	1Ω ~ 4.7MΩ					10Ω ~ 4.7MΩ
TCR (ppm/°C)	10Ω ~ 4.7MΩ: ±200 ppm/°C 1Ω ~ 9.1Ω: - 200 ~ +500 ppm/°C					±200 ppm/°C
Max. dissipation @ Tamb=70°C	1 W	1/2 W	1/4 W	1/8 W	1/10 W	1/16 W
Max. Operation Voltage (DC or RMS)	200V	200V	200V	200V	150V	50V
Operation Temperature	-55 ~ +125°C					
Basic Specification	JIS C 5201-1 / IEC 60115-1					

■ WKxxV Series of High Voltage Chip Resistor

■ Feature

1. Special material and design for high working voltage required
2. Compatible with flow and reflow soldering.
3. Suitable for lead free soldering.

■ Application

1. Power supply.
2. Automotive industry.
3. Measurement instrument.
4. Back light inverter.
5. Medical or Military equipment

■ Quick Reference Data

Series No.	WK25N	WK20N	WK25V	WK20V	WK12V	WK08V	WK06V
Size code	2512 (6332)	2010 (5025)	2512 (6332)	2010 (5025)	1206(3216)	0805(2012)	0603(1608)
Resistance Tolerance	±5% ; ±10%		±5% ; ±1%				
Resistance Range	4.7MΩ ~ 16MΩ	1MΩ ~ 16MΩ	47Ω ~ 51MΩ				47Ω ~ 10MΩ
TCR (ppm/°C)	± 200 ppm/°C * detail refer to data sheet						
Max. dissipation @ Tamb=70°C	1 W	1/2 W	1 W	1/2 W	1/4 W	1/8 W	1/10 W
Max. Operation Voltage (DC or RMS)	2000V	1500V	800V	500V	500V	400V	200V
Operation Temperature	-55 ~ +125°C						

Note:

1. This is the maximum voltage that may be continuously supplied to the resistor element, see "IEC publication 60115-8".
2. Max. Operation Voltage: So called RCWW (Rated Continuous Working Voltage) is determined by $RCWV = \sqrt{\text{Rater Power} \times \text{Resistance Value}}$ or Max. RCWV listed above, whichever is lower.

■ Physical Dimensions

Unit: mm

Symbol	WK25N	WK20N	WK25V	WK20V	WK12V	WK08V	WK06V
L	6.30±0.15	5.00±0.15	6.30±0.15	5.00±0.15	3.10±0.15	2.00±0.10	1.60±0.10
W	3.20±0.15	2.50±0.15	3.20±0.15	2.50±0.15	1.60±0.15	1.25±0.10	0.80+0.15/-0.10
T	0.55±0.15	0.55±0.15	0.55±0.15	0.55±0.15	0.55±0.10	0.55±0.10	0.45±0.10
Tt	0.60±0.20	0.50±0.20	0.60±0.20	0.60±0.20	0.50±0.25	0.40±0.20	0.30±0.10
Tb	0.60±0.20	0.60±0.20	0.60±0.20	0.60±0.20	0.50±0.25	0.40±0.20	0.30±0.10

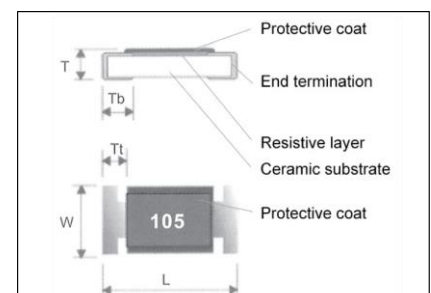

■ WFxxP Series of High Power Chip Resistor

■ Feature

1. High power rating and compact size
2. High reliability and stability
3. Reduced size of final equipment
4. Lead free product is upon customer requested.

■ Application

1. Power supply
2. PDA
3. Digital meter
4. Computer
5. Automotives.

■ Quick Reference Data

Item	General Specification						
Series No.	WF25P	WF20P	WF10P	WF12P	WF08P	WF06P	WF04P
Size code	2512(6432)	2010(5025)	1210(3225)	1206(3216)	0805(2012)	0603 (1608)	0402(1005)
Resistance Tolerance	±1% , ±5%						
Resistance Range	0Ω, 1Ω ~ 1MΩ						
TCR (ppm/°C)	± 100 ppm/°C						
Max. dissipation @ Tamb=70°C	2W	1W	1/2W	1/2W	1/4W	1/8W	1/8W
Max. Operation Voltage (DC or RMS)	300V	200V	200V	200V	150V	50V	50V
Operation Temperature	-55 ~ +155°C						

Note:

1. This is the maximum voltage that may be continuously supplied to the resistor element, see "IEC publication 60115-8".
2. Max. Operation Voltage: So called RCWV (Rated Continuous Working Voltage) is determined by $RCWV = \sqrt{\text{Rated Power} \times \text{Resistance Value}}$ or Max. RCWV listed above, whichever is lower.
3. 2W loading with total solder-pad and trace size of 300mm²
4. 0Ω maximum resistance Rmax < 15mΩ and rated current < 4Amp

■ Physical Dimensions

Unit: mm

Symbol	WF25P	WF20P	WF10P	WF12P	WF08P	WF06P	WF04P
L	6.30±0.20	5.00±0.20	3.10±0.10	3.10±0.15	2.00±0.15	1.60±0.10	1.00±0.05
W	3.10±0.20	2.50±0.20	2.60±0.10	1.60±0.15	1.20±0.15	0.80±0.10	0.50±0.05
T	0.60±0.15	0.60±0.10	0.55±0.10	0.55±0.10	0.50±0.10	0.45±0.10	0.35±0.05
Tt	0.60±0.25	0.60±0.25	0.50±0.20	0.50±0.25	0.40±0.20	0.30±0.20	0.25±0.10
Tb	1.80±0.25	0.60±0.25	0.50±0.20	0.50±0.25	0.40±0.20	0.30±0.20	0.25±0.10

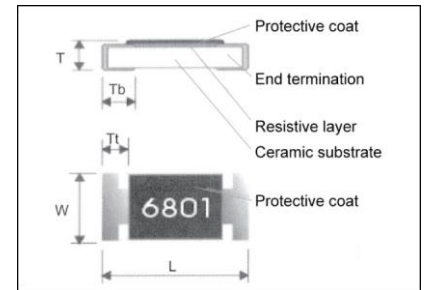

■ WKxxS Series of Anti-Surge Chip Resistors

■ Feature

1. Power rating and compact size
2. High reliability and stability
3. Reduced size of final equipment
4. Surge protection.

■ Application

1. Power supply.
2. Measurement instrument.
3. Automotive industry.
4. Medical or Military equipment.

■ Quick Reference Data

Item	General Specification				
Series No.	WK25S	WK20S	WK10S	WK12S	WK08S
Size code	2512(6432)	2010(5025)	1210(3225)	1206(3216)	0805(2012)
Resistance Tolerance	±5% , ±10% , ±20%,(E24)				
Resistance Range	0.27Ω ~ 22MΩ				
TCR (ppm/°C)	± 200 ppm/°C				
Max. dissipation @ Tamb=70°C	1 W	3/4W	1/2W	1/4W	1/8W
Max. Operation Voltage (DC or RMS)	200V				150V
Operation Temperature	-55 ~ +155°C				

Note:

1. This is the maximum voltage that may be continuously supplied to the resistor element, see "IEC publication 60115-8".
2. Max. Operation Voltage: So called RCWV (Rated Continuous Working Voltage) is determined by $RCWV = \sqrt{\text{Rated Power} \times \text{Resistance Value}}$ or Max. RCWV listed above, whichever is lower.

■ Physical Dimensions

Unit: mm

Symbol	WK25S	WK20S	WK10S	WK12S	WK08S
L	6.30±0.15	5.00±0.15	3.20±0.15	3.20±0.15	2.00±0.10
W	3.20±0.15	2.50±0.15	2.50±0.15	1.60±0.15	1.25±0.10
T	0.55±0.15	0.55±0.15	0.55±0.15	0.55±0.10	0.55±0.10
Tt	0.30±0.15	0.30±0.15	0.30±0.20	0.30±0.20	0.30±0.20
Tb	0.60±0.20	0.60±0.20	0.50±0.25	0.50±0.25	0.40±0.20

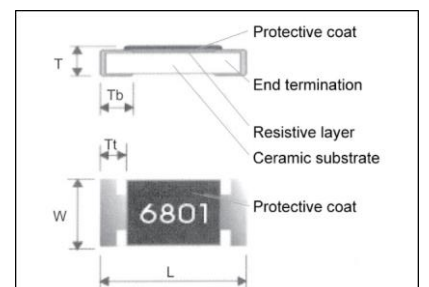
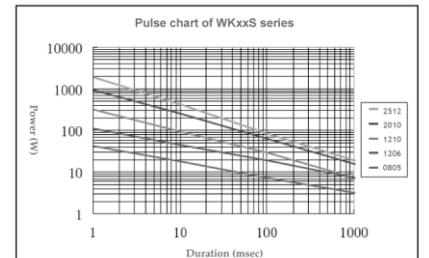

■ Thick Film High precision Chip Resistor

■ Narrow Tolerance Thick Film TC100 WFxxH Series (E96+E24 series)

Series No.	WF12H	WF08H	WF06H	WF04H
Size	1206(3216)	0805(2012)	0603(1608)	0402(1005)
Resistance Tolerance	±0.5% , ±0.1%			
Resistance Range	10Ω ~ 1MΩ (E96+E24 series)			
TCR (ppm/°C)	±100 ppm/°C			
Max. dissipation @ Tamb=70°C	1/4 W	1/8 W	1/10 W	1/16 W
Max. Operation Voltage (DC or RMS)	200V	100V	50V	50V
Operation Temperature	-55 ~ +155°C			
Basic Specification	JIS C5201-1 / IEC 60115-1			

(Detail specification please refer to specific data sheets)

■ Thin Film Precision Chip Resistor- WF Series

■ Feature

1. SMD metal film resistor
2. High reliability and stability of 0.25% and below per customer request
3. High performance of TCR: 50 ppm/°C and below per customer request
4. Low current noise
5. RoHS compliant and lead free

■ Application

1. Medical equipment
2. Measuring instrument
3. Communication device
4. Computer

■ Narrow Tolerance Thin Film TC50 WFxxT/WFxxQ (Power) Series (E192+E24 series)

Series No.	WF25T	WF20T	WF10T	WF12T	WF08T	WF06T	WF04T	WF02T
Size	2512(6432)	2010(5025)	1210(3225)	1206 (3216)	0805 (2012)	0603 (1608)	0402 (1005)	0201 (0603)
Resistance Tolerance	±1%, ±0.5% , ±0.1%, ±0.05%, ±0.01%							
Resistance Range	4.7 ~ 3MΩ	4.7 ~ 3MΩ	4.7 ~ 2.49MΩ	4.7 ~ 2.49MΩ	4.7 ~ 2MΩ	4.7 ~ 1MΩ	10 ~ 255KΩ	100 ~ 12KΩ
TCR (ppm/°C)	±50 ppm/°C							
Max. dissipation @ Tamb=70°C	3/4W	1/2W	1/4W	1/8W	1/10W	1/16W	1/16W	1/32W
Max. Operation Voltage (DC or RMS)	200V	200V	200V	200V	100V	50V	50V	15V
Operation Temperature	-55 ~ +155°C							
Basic Specification	JIS C5201-1 / IEC 60115-1							

Series No.	WF25Q	WF20Q	WF10Q	WF12Q	WF08Q	WF06Q	WF04Q	WF02Q
Size	2512(6432)	2010(5025)	1210(3225)	1206 (3216)	0805 (2012)	0603 (1608)	0402 (1005)	0201 (0603)
Resistance Tolerance	±1%, ±0.5% , ±0.1%, ±0.05%, ±0.01%							
Resistance Range	10 ~ 1.5MΩ	10 ~ 1.5MΩ	10 ~ 1MΩ	4.7 ~ 1MΩ	4.7 ~ 1MΩ	4.7 ~ 680KΩ	10 ~ 100KΩ	27 ~ 22KΩ
TCR (ppm/°C)	±50 ppm/°C							
Max. dissipation @ Tamb=70°C	1W	3/4W	2/5W	1/4W	1/8W	1/10W	1/10W	1/20W
Max. Operation Voltage (DC or RMS)	200V	200V	200V	200V	150V	75V	50V	15V
Operation Temperature	-55 ~ +155°C							
Basic Specification	JIS C5201-1 / IEC 60115-1							

(Detail specification please refer to specific data sheets)

■ Narrow Tolerance Thin Film TC25 WFxxU/ WFxxR (Power) Series (E192+E24 series)

Series No.	WF25U	WF20U	WF10U	WF12U	WF08U	WF06U	WF04U	WF02U
Size	2512(6432)	2010(5025)	1210(3225)	1206 (3216)	0805 (2012)	0603 (1608)	0402 (1005)	0201 (0603)
Resistance Tolerance	±1%, ±0.5% , ±0.1%, ±0.05%, ±0.01%							
Resistance Range	4.7 ~ 3MΩ	4.7 ~ 3MΩ	4.7 ~ 2.49MΩ	4.7 ~ 2.49MΩ	4.7 ~ 2MΩ	4.7 ~ 1MΩ	10 ~ 255KΩ	100 ~ 12KΩ
TCR (ppm/°C)	±25 ppm/°C							
Max. dissipation @ Tamb=70°C	3/4W	1/2W	1/4W	1/8W	1/10W	1/16W	1/16W	1/32W
Max. Operation Voltage (DC or RMS)	200V	200V	200V	200V	100V	50V	50V	15V
Operation Temperature	-55 ~ +155°C							
Basic Specification	JIS C5201-1 / IEC 60115-1							

Series No.	WF25R	WF20R	WF10R	WF12R	WF08R	WF06R	WF04R	WF02R
Size	2512(6432)	2010(5025)	1210(3225)	1206 (3216)	0805 (2012)	0603 (1608)	0402 (1005)	0201 (0603)
Resistance Tolerance	±1%, ±0.5% , ±0.1%, ±0.05%, ±0.01%							
Resistance Range	10 ~ 1.5MΩ	10 ~ 1.5MΩ	10 ~ 1MΩ	4.7 ~ 1MΩ	4.7 ~ 1MΩ	4.7 ~ 680KΩ	10 ~ 100KΩ	27 ~ 12KΩ
TCR (ppm/°C)	±25 ppm/°C							
Max. dissipation @ Tamb=70°C	1W	3/4W	2/5W	1/4W	1/8W	1/10W	1/10W	1/20W
Max. Operation Voltage (DC or RMS)	200V	200V	200V	200V	150V	75V	50V	15V
Operation Temperature	-55 ~ +155°C							
Basic Specification	JIS C5201-1 / IEC 60115-1							

(Detail specification please refer to specific data sheets)

■ Thin Film Precision Chip Resistor- WF Series

■ Narrow Tolerance Thin Film TC15 WFxxF Series (E192+E24 series)

Series No.	WF25F	WF20F	WF10F	WF12F	WF08F	WF06F	WF04F
Size	2512(6432)	2010(5025)	1210(3225)	1206 (3216)	0805 (2012)	0603 (1608)	0402 (1005)
Resistance Tolerance	±1%, ±0.5%, ±0.1%, ±0.05%, ±0.01%						
Resistance Range	4.7 ~ 1.5MΩ	4.7 ~ 900KΩ	4.7 ~ 400KΩ	4.7 ~ 300KΩ	4.7 ~ 200KΩ	4.7 ~ 100KΩ	10 ~ 20KΩ
TCR (ppm/°C)	±15 ppm/°C						
Max. dissipation @ Tamb=70°C	3/4W	1/2W	1/4W	1/4W	1/8W	1/10W	1/16W
Max. Operation Voltage (DC or RMS)	200V	200V	200V	200V	100V	75V	50V
Operation Temperature	-55 ~ +155°C						
Basic Specification	JIS C5201-1 / IEC 60115-1						

(Detail specification please refer to specific data sheets)

* Sample is available upon request

■ Narrow Tolerance Thin Film TC10 WFxxW Series (E192+E24 series)

Series No.	WF25W	WF20W	WF10W	WF12W	WF08W	WF06W	WF04W
Size	2512(6432)	2010(5025)	1210(3225)	1206 (3216)	0805 (2012)	0603 (1608)	0402 (1005)
Resistance Tolerance	±1%, ±0.5%, ±0.1%, ±0.05%, ±0.01%						
Resistance Range	4.7 ~ 1.5MΩ	4.7 ~ 900KΩ	4.7 ~ 400KΩ	4.7 ~ 300KΩ	4.7 ~ 200KΩ	4.7 ~ 100KΩ	10 ~ 20KΩ
TCR (ppm/°C)	±10 ppm/°C						
Max. dissipation @ Tamb=70°C	3/4W	1/2W	1/4W	1/4W	1/8W	1/10W	1/16W
Max. Operation Voltage (DC or RMS)	200V	200V	200V	200V	100V	75V	50V
Operation Temperature	-55 ~ +155°C						
Basic Specification	JIS C5201-1 / IEC 60115-1						

(Detail specification please refer to specific data sheets)

■ Narrow Tolerance Thin Film TC5 WFxxZ Series (E192+E24 series)

Series No.	WF25Z	WF20Z	WF10Z	WF12Z	WF08Z	WF06Z	WF04Z
Size	2512(6432)	2010(5025)	1210(3225)	1206 (3216)	0805 (2012)	0603 (1608)	0402 (1005)
Resistance Tolerance	±1%, ±0.5%, ±0.1%, ±0.05%, ±0.01%						
Resistance Range	4.7 ~ 600KΩ	4.7 ~ 360KΩ	4.7 ~ 150KΩ	4.7 ~ 150KΩ	4.7 ~ 100KΩ	4.7 ~ 50KΩ	10 ~ 10KΩ
TCR (ppm/°C)	±5 ppm/°C						
Max. dissipation @ Tamb=70°C	3/4W	1/2W	1/4W	1/4W	1/8W	1/10W	1/16W
Max. Operation Voltage (DC or RMS)	200V	200V	200V	200V	100V	75V	25V
Operation Temperature	-55 ~ +155°C						
Basic Specification	JIS C5201-1 / IEC 60115-1						

(Detail specification please refer to specific data sheets)

■ Narrow Tolerance Thin Film TC3 WFxxB Series (E192+E24 series)

Series No.	WF25B	WF20B	WF10B	WF12B	WF08B	WF06B	WF04B
Size	2512(6432)	2010(5025)	1210(3225)	1206 (3216)	0805 (2012)	0603 (1608)	0402 (1005)
Resistance Tolerance	±1%, ±0.5%, ±0.1%, ±0.05%, ±0.01%						
Resistance Range	4.7 ~ 600KΩ	4.7 ~ 360KΩ	4.7 ~ 150KΩ	4.7 ~ 120KΩ	4.7 ~ 80KΩ	4.7 ~ 40KΩ	10 ~ 8KΩ
TCR (ppm/°C)	±3 ppm/°C						
Max. dissipation @ Tamb=70°C	3/4W	1/2W	1/4W	1/4W	1/8W	1/10W	1/16W
Max. Operation Voltage (DC or RMS)	200V	200V	200V	200V	100V	75V	25V
Operation Temperature	-55 ~ +155°C						
Basic Specification	JIS C5201-1 / IEC 60115-1						

* Sample is available upon request. (Detail specification please refer to specific data sheets)

■ Narrow Tolerance Thin Film TC2 WFxxC Series (E192+E24 series)

Series No.	WF25C	WF20C	WF10C	WF12C	WF08C	WF06C	WF04C
Size	2512(6432)	2010(5025)	1210(3225)	1206 (3216)	0805 (2012)	0603 (1608)	0402 (1005)
Resistance Tolerance	±1%, ±0.5%, ±0.1%, ±0.05%, ±0.01%						
Resistance Range	4.7 ~ 600KΩ	4.7 ~ 360KΩ	4.7 ~ 150KΩ	4.7 ~ 120KΩ	4.7 ~ 80KΩ	4.7 ~ 40KΩ	10 ~ 8KΩ
TCR (ppm/°C)	±2 ppm/°C						
Max. dissipation @ Tamb=70°C	3/4W	1/2W	1/4W	1/4W	1/8W	1/10W	1/16W
Max. Operation Voltage (DC or RMS)	200V	200V	200V	200V	100V	75V	25V
Operation Temperature	-55 ~ +155°C						
Basic Specification	JIS C5201-1 / IEC 60115-1						

(Detail specification please refer to specific data sheets)

■ Thin Film Professional Chip Resistor (AEC-Q200)- WF_Q Series

■ Feature

1. NiCr Thin Film Resistor
2. AEC-Q200 Qualified
3. High reliability and stability of 0.25%
4. TCR down to 5ppm/°C and below per Customer Request.
5. Tight Tolerance : 0.01%
6. Low current noise
7. RoHS compliant and lead free.

■ Application

1. Medical equipment
2. Measuring instrument
3. Communication device
4. Electronic Energy Meter
5. Audio System.

■ AEC-Q200/ Thin Film TC25 WFxxU_Q / WFxxR_Q Series (E192+E24 series)

Series No.	WF25U_Q	WF20U_Q	WF10U_Q	WF12U_Q	WF08U_Q	WF06U_Q	WF04U_Q
Size	2512(6432)	2010(5025)	1210(3225)	1206 (3216)	0805 (2012)	0603 (1608)	0402 (1005)
Resistance Tolerance	±1%, ±0.5%, ±0.25%, ±0.1%, ±0.05%,						
Resistance Range	10Ω ~ 1.5MΩ	10Ω ~ 1.5MΩ	10Ω ~ 1MΩ	4.7Ω ~ 1MΩ	4.7Ω ~ 1MΩ	4.7Ω~ 680KΩ	10Ω~ 100KΩ
TCR (ppm/°C)	±25 ppm/°C						
Max. dissipation @ Tamb=70°C	3/4W	1/2W	1/4W	1/8W	1/10W	1/16W	1/16W
Max. Operation Voltage (DC or RMS)	200V	200V	200V	200V	100V	50V	50V
Operation Temperature	-55 ~ +155°C						
Basic Specification	JIS C5201-1 / IEC 60115-1 /AEC-Q200						

Series No.	WF25R_Q	WF20R_Q	WF10R_Q	WF12R_Q	WF08R_Q	WF06R_Q	WF04R_Q
Size	2512(6432)	2010(5025)	1210(3225)	1206 (3216)	0805 (2012)	0603 (1608)	0402 (1005)
Resistance Tolerance	±1%, ±0.5%, ±0.25%, ±0.1%, ±0.05%,						
Resistance Range	10 ~ 1.5MΩ	10 ~ 1.5MΩ	10 ~ 1MΩ	4.7 ~ 1MΩ	4.7 ~ 1MΩ	4.7 ~ 680KΩ	10 ~ 100KΩ
TCR (ppm/°C)	±25 ppm/°C						
Max. dissipation @ Tamb=70°C	1W	3/4W	2/5W	1/4W	1/8W	1/10W	1/10W
Max. Operation Voltage (DC or RMS)	200V	200V	200V	200V	150V	75V	50V
Operation Temperature	-55 ~ +155°C						
Basic Specification	JIS C5201-1 / IEC 60115-1 /AEC-Q200						

(Detail specification please refer to specific data sheets)

■ AEC-Q200/ Thin Film TC15 WFxxF_Q Series (E192+E24 series)

Series No.	WF25F_Q	WF20F_Q	WF10F_Q	WF12F_Q	WF08F_Q	WF06F_Q	WF04F_Q
Size	2512(6432)	2010(5025)	1210(3225)	1206 (3216)	0805 (2012)	0603 (1608)	0402 (1005)
Resistance Tolerance	±1%, ±0.5%, ±0.25%, ±0.1%, ±0.05%,						
Resistance Range	25Ω ~ 1MΩ	25Ω ~ 900KΩ	25Ω ~ 400KΩ	25Ω ~ 300KΩ	25Ω ~ 200KΩ	25Ω ~ 100KΩ	25Ω ~ 20KΩ
TCR (ppm/°C)	±15 ppm/°C						
Max. dissipation @ Tamb=70°C	3/4W	1/2W	1/4W	1/8W	1/8W	1/10W	1/16W
Max. Operation Voltage (DC or RMS)	200V	200V	200V	150V	100V	50V	25V
Operation Temperature	-55 ~ +155°C						
Basic Specification	JIS C5201-1 / IEC 60115-1/AEC-Q200						

(Detail specification please refer to specific data sheets)

■ AEC-Q200 / Thin Film TC10 WFxxW_Q Series (E192+E24 series)

Series No.	WF25W_Q	WF20W_Q	WF10W_Q	WF12W_Q	WF08W	WF06W	WF04W
Size	2512(6432)	2010(5025)	1210(3225)	1206 (3216)	0805 (2012)	0603 (1608)	0402 (1005)
Resistance Tolerance	±1%, ±0.5%, ±0.25%, ±0.1%, ±0.05%,						
Resistance Range	25Ω ~ 1MΩ	25Ω ~ 900KΩ	25Ω ~ 400KΩ	25Ω ~ 300KΩ	25Ω ~ 200KΩ	25Ω ~ 100KΩ	25Ω ~ 20KΩ
TCR (ppm/°C)	±10 ppm/°C						
Max. dissipation @ Tamb=70°C	3/4W	1/2W	1/4W	1/8W	1/8W	1/10W	1/16W
Max. Operation Voltage (DC or RMS)	200V	200V	200V	150V	100V	50V	25V
Operation Temperature	-55 ~ +155°C						
Basic Specification	JIS C5201-1 / IEC 60115-1 /AEC-Q200						

(Detail specification please refer to specific data sheets)

■ AEC-Q200 / Thin Film TC5 WFxxZ_Q Series (E192+E24 series)

Series No.	WF25Z_Q	WF20Z_Q	WF10Z_Q	WF12Z_Q	WF08Z_Q	WF06Z_Q	WF04Z_Q
Size	2512(6432)	2010(5025)	1210(3225)	1206 (3216)	0805 (2012)	0603 (1608)	0402 (1005)
Resistance Tolerance	±1%, ±0.5%, ±0.25%, ±0.1%, ±0.05%,						
Resistance Range	25Ω ~ 600KΩ	25Ω~ 360KΩ	25Ω ~ 150KΩ	25Ω ~ 120KΩ	25Ω ~ 80KΩ	25Ω ~ 80KΩ	25Ω ~ 8KΩ
TCR (ppm/°C)	±5 ppm/°C						
Max. dissipation @ Tamb=70°C	3/4W	1/2W	1/4W	1/8W	1/8W	1/10W	1/16W
Max. Operation Voltage (DC or RMS)	200V	200V	200V	150V	100V	50V	25V
Operation Temperature	-55 ~ +155°C						
Basic Specification	JIS C5201-1 / IEC 60115-1 /AEC-Q200						

(Detail specification please refer to specific data sheets)

■ Thin Film Anti-Sulfuration (AEC-Q200)- SF_Q Series

■ Feature

1. SMD metal film resistor
2. High reliability and stability of 0.5% and below per customer request
3. High performance of TCR: 15 ppm/K and below per customer request
4. Low current noise
5. RoHS compliant and lead free
6. AEC-Q200 qualified
7. Sulfuration resistant against ASTM B-809-95*.

■ Application

1. Automotive
2. Medical equipment
3. Measuring instrument
4. Communication device
5. Computer
6. Printer

■ AEC-Q200/ Thin Film TC25 SFxxR_Q / SFxxU_Q (Power) Series (E192+E24 series)

Series No.	SF25R_Q	SF20R_Q	SF10R_Q	SF12R_Q	SF08R_Q	SF06R_Q	SF04R_Q
Size	2512(6432)	2010(5025)	1210(3225)	1206(3216)	0805(2012)	0603(1608)	0402(1005)
Resistance Tolerance	±1%, ±0.5%, ±0.25%, ±0.1%, ±0.05%*						
Resistance Range	10Ω ~1.5MΩ	10Ω ~1.5MΩ	10Ω ~1MΩ	4.7Ω ~ 1MΩ	4.7Ω~ 1MΩ	4.7Ω~ 680KΩ	10Ω ~ 100KΩ
TCR (ppm/°C)	±25 ppm/°C						
Max. dissipation @ Tamb=70°C	1W	3/4W	2/5W	1/4W	1/8W	1/10W	1/10W
Max. Operation Voltage (DC or RMS)	200V	200V	200V	200V	150V	75V	50V
Operation Temperature	-55 ~ +155°C						
Basic Specification	JIS C5201-1 / IEC 60115-1 / ASTM B-809 / AEC-Q200						

Series No.	SF25U_Q	SF20U_Q	SF10U_Q	SF12U_Q	SF08U_Q	SF06U_Q	SF04U_Q
Size	2512(6432)	2010(5025)	1210(3225)	1206(3216)	0805(2012)	0603(1608)	0402(1005)
Resistance Tolerance	±1%, ±0.5%, ±0.25%, ±0.1%, ±0.05%*						
Resistance Range	10Ω ~1.5MΩ	10Ω ~1.5MΩ	10Ω ~1MΩ	4.7Ω ~ 1MΩ	4.7Ω~ 1MΩ	4.7Ω~ 680KΩ	10Ω ~ 100KΩ
TCR (ppm/°C)	±25 ppm/°C						
Max. dissipation @ Tamb=70°C	3/4W	1/2W	1/4W	1/8W	1/10W	1/16W	1/16W
Max. Operation Voltage (DC or RMS)	200V	200V	200V	200V	100V	50V	50V
Operation Temperature	-55 ~ +155°C						
Basic Specification	JIS C5201-1 / IEC 60115-1 / ASTM B-809 / AEC-Q200						

■ AEC-Q200/ Thin Film TC15 SFxxF_Q Series (E192+E24 series)

Series No.	SF25F_Q	SF20F_Q	SF10F_Q	SF12F_Q	SF08F_Q	SF06F_Q	SF04F_Q
Size	2512(6432)	2010(5025)	1210(3225)	1206(3216)	0805(2012)	0603(1608)	0402(1005)
Resistance Tolerance	±1%, ±0.5%, ±0.25%, ±0.1%, ±0.05%*						
Resistance Range	25Ω ~1MΩ	25Ω ~900KΩ	25Ω ~400KΩ	25Ω ~300KΩ	25Ω ~200KΩ	25Ω~ 100KΩ	25Ω ~ 20KΩ
TCR (ppm/°C)	±15 ppm/°C						
Max. dissipation @ Tamb=70°C	3/4W	1/2W	1/4W	1/8W	1/8W	1/10W	1/16W
Max. Operation Voltage (DC or RMS)	200V	200V	200V	150V	100V	50V	25V
Operation Temperature	-55 ~ +155°C						
Basic Specification	JIS C5201-1 / IEC 60115-1 / ASTM B-809 / AEC-Q200						

■ AEC-Q200/ Thin Film TC10 SFxxW_Q Series (E192+E24 series)

Series No.	SF25W_Q	SF20W_Q	SF10W_Q	SF12W_Q	SF08W_Q	SF06W_Q	SF04W_Q
Size	2512(6432)	2010(5025)	1210(3225)	1206(3216)	0805(2012)	0603(1608)	0402(1005)
Resistance Tolerance	±1%, ±0.5%, ±0.25%, ±0.1%, ±0.05%*						
Resistance Range	25Ω ~1MΩ	25Ω ~900KΩ	25Ω ~400KΩ	25Ω ~300KΩ	25Ω ~200KΩ	25Ω~ 100KΩ	25Ω ~ 20KΩ
TCR (ppm/°C)	±10 ppm/°C						
Max. dissipation @ Tamb=70°C	3/4W	1/2W	1/4W	1/8W	1/8W	1/10W	1/16W
Max. Operation Voltage (DC or RMS)	200V	200V	200V	150V	100V	50V	25V
Operation Temperature	-55 ~ +155°C						
Basic Specification	JIS C5201-1 / IEC 60115-1 / ASTM B-809 / AEC-Q200						

■ AEC-Q200/ Thin Film TC5 SFxxZ_Q Series (E192+E24 series)

Series No.	SF25Z_Q	SF20Z_Q	SF10Z_Q	SF12Z_Q	SF08Z_Q	SF06Z_Q	SF04Z_Q
Size	2512(6432)	2010(5025)	1210(3225)	1206(3216)	0805(2012)	0603(1608)	0402(1005)
Resistance Tolerance	±1%, ±0.5%, ±0.25%, ±0.1%, ±0.05%*						
Resistance Range	25Ω ~600KΩ	25Ω ~360KΩ	25Ω ~150KΩ	25Ω ~120KΩ	25Ω ~80KΩ	25Ω~ 40KΩ	25Ω ~ 8KΩ
TCR (ppm/°C)	±5 ppm/°C						
Max. dissipation @ Tamb=70°C	3/4W	1/2W	1/4W	1/8W	1/8W	1/10W	1/16W
Max. Operation Voltage (DC or RMS)	200V	200V	200V	150V	100V	50V	25V
Operation Temperature	-55 ~ +155°C						
Basic Specification	JIS C5201-1 / IEC 60115-1 / ASTM B-809 / AEC-Q200						

(Detail specification please refer to specific data sheets)

■ Thin Film Anti-Sulfuration- SF Series

■ Feature

1. SMD metal film resistor
2. High reliability and stability of 0.5% and below per customer request
3. High performance of TCR: 25 ppm/K and below per customer request
4. Low current noise
5. Sulfuration resistant against ASTM B-809
6. RoHS compliant and Lead free.

■ Application

1. Farming and industrial Equipment
2. Medical equipment
3. Measuring instrument
4. Communication device.

■ Anti-Sulfuration Thin Film TC50 SFxxQ (Power) / SFxxT Series (E192+E24 series)

Series No.	SF25Q	SF20Q	SF10Q	SF12Q	SF08Q	SF06Q	SF04Q
Size	2512(6432)	2010(5025)	1210(3225)	1206(3216)	0805(2012)	0603(1608)	0402(1005)
Resistance Tolerance	±1% , ±0.5% , ±0.25% , ±0.1% , ±0.05%*						
Resistance Range	10Ω ~1.5MΩ	10Ω ~1.5MΩ	10Ω ~1MΩ	4.7Ω ~ 1MΩ	4.7Ω~ 1MΩ	4.7Ω~ 680KΩ	10Ω ~ 100KΩ
TCR (ppm/°C)	±50 ppm/°C						
Max. dissipation @ Tamb=70°C	1W	3/4W	2/5W	1/4W	1/8W	1/10W	1/10W
Max. Operation Voltage (DC or RMS)	200V	200V	200V	200V	150V	75V	50V
Operation Temperature	-55 ~ +155°C						
Basic Specification	JIS C5201-1 / IEC 60115-1 / ASTM B-809						

Series No.	SF25T	SF20T	SF10T	SF12T	SF08T	SF06T	SF04T
Size	2512(6432)	2010(5025)	1210(3225)	1206(3216)	0805(2012)	0603(1608)	0402(1005)
Resistance Tolerance	±1% , ±0.5% , ±0.25% , ±0.1% , ±0.05%*						
Resistance Range	4.7Ω ~3MΩ	4.7Ω ~3MΩ	4.7Ω ~2.49MΩ	4.7Ω ~2.49MΩ	4.7Ω ~2MΩ	4.7Ω~ 1MΩ	10Ω ~ 255KΩ
TCR (ppm/°C)	±50ppm/°C						
Max. dissipation @ Tamb=70°C	3/4W	1/2W	1/4W	1/8W	1/10W	1/16W	1/16W
Max. Operation Voltage (DC or RMS)	200V	200V	200V	200V	150V	75V	50V
Operation Temperature	-55 ~ +155°C						
Basic Specification	JIS C5201-1 / IEC 60115-1 / ASTM B-809						

■ Anti-Sulfuration Thin Film TC25 SFxxR (Power) / SFxxU Series (E192+E24 series)

Series No.	SF25R	SF20R	SF10R	SF12R	SF08R	SF06R	SF04R
Size	2512(6432)	2010(5025)	1210(3225)	1206(3216)	0805(2012)	0603(1608)	0402(1005)
Resistance Tolerance	±1% , ±0.5% , ±0.25% , ±0.1% , ±0.05%*						
Resistance Range	10Ω ~1.5MΩ	10Ω ~1.5MΩ	10Ω ~1MΩ	4.7Ω ~ 1MΩ	4.7Ω~ 1MΩ	4.7Ω~ 680KΩ	10Ω ~ 100KΩ
TCR (ppm/°C)	±25 ppm/°C						
Max. dissipation @ Tamb=70°C	1W	3/4W	2/5W	1/4W	1/8W	1/10W	1/10W
Max. Operation Voltage (DC or RMS)	200V	200V	200V	200V	150V	75V	50V
Operation Temperature	-55 ~ +155°C						
Basic Specification	JIS C5201-1 / IEC 60115-1 / ASTM B-809						

Series No.	SF25U	SF20U	SF10U	SF12U	SF08U	SF06U	SF04U
Size	2512(6432)	2010(5025)	1210(3225)	1206(3216)	0805(2012)	0603(1608)	0402(1005)
Resistance Tolerance	±1% , ±0.5% , ±0.25% , ±0.1% , ±0.05%*						
Resistance Range	4.7Ω ~3MΩ	4.7Ω ~3MΩ	4.7Ω ~2.49MΩ	4.7Ω ~2.49MΩ	4.7Ω ~2MΩ	4.7Ω~ 1MΩ	10Ω ~ 255KΩ
TCR (ppm/°C)	±25 ppm/°C						
Max. dissipation @ Tamb=70°C	3/4W	1/2W	1/4W	1/8W	1/10W	1/16W	1/16W
Max. Operation Voltage (DC or RMS)	200V	200V	200V	200V	100V	50V	25V
Operation Temperature	-55 ~ +155°C						
Basic Specification	JIS C5201-1 / IEC 60115-1 / ASTM B-809						

■ Anti-Sulfuration Thin Film TC10 SFxxW Series (E192+E24 series)

Series No.	SF06W	SF04W
Size	0603(1608)	0402(1005)
Resistance Tolerance	±1% , ±0.5% , ±0.25% , ±0.1% , ±0.05%*	
Resistance Range	10Ω ~100KΩ	100Ω ~20KΩ
TCR (ppm/°C)	±10 ppm/°C	
Max. dissipation @ Tamb=70°C	1/10W	1/16W
Max. Operation Voltage (DC or RMS)	75V	25V
Operation Temperature	-55 ~ +155°C	
Basic Specification	JIS C5201-1 / IEC 60115-1 / ASTM B-809	

(Detail specification please refer to specific data sheets)

■ TaN Thin Film Chip Resistors (Auto Grade/AEC-Q200) - MF Series

■ Feature

1. SMD TaN thin film resistor
2. Special passivation layer on resistive file
3. AEC-Q200 qualified
4. Products with lead free terminations meet RoHS requirements
5. Sulfur resistant (per ASTM B809-95 humid vapor test)
6. Laser trimmed to any value.

■ Application

1. Professional Industrial equipment
2. Automotive
3. Medical equipment
4. Measuring instrument
5. Industrial Equipment.

■ Tight Tolerance Thin Film TC25/50 MFxxR / MFxxQ Series (E192+E24 series)

Series No.	MF12R	MF08R	MF06R	MF04R	MF12Q	MF08Q	MF06Q	MF04Q
Size	1206(3216)	0805(2012)	0603(1608)	0402(1005)	1206 (3216)	0805 (2012)	0603 (1608)	0402 (1005)
Resistance Tolerance	±1% , ±0.5% , ±0.25% , ±0.1% , ±0.05% ,				±1% , ±0.5% , ±0.25% , ±0.1% , ±0.05% ,			
Resistance Range	10Ω ~ 1MΩ	10Ω ~ 350KΩ	40Ω ~ 130KΩ	40Ω ~ 35KΩ	10Ω ~ 1MΩ	10Ω ~ 350KΩ	40Ω ~ 130KΩ	40Ω ~ 35KΩ
TCR (ppm/°C)	±25 ppm/°C				±50 ppm/°C			
Max. dissipation at T _{amb} =85°C	0.4W	0.2W	0.15W	0.063W	0.4W	0.2W	0.15W	0.063W
Max. Operation Voltage (DC or RMS)	200V	100V	75V	50V	200V	100V	75V	50V
Operation Temperature	-55 ~ +155°C				-55 ~ +155°C			
Basic Specification	JIS C5201-1 / IEC 60115-1 / AEC Q200 /ASTM B-809				JIS C5201-1 / IEC 60115-1 / AEC Q200 /ASTM B-809			

* Available Upon Request. (Detail specification please refer to specific data sheets)

■ Thin Film Low Ohmic Chip Resistor (Low TCR) - WW Series

■ Feature

1. SMD metal film resistor
2. High reliability and stability of 5% and below per customer request
3. High performance of TCR: 75 ppm/K and below per customer request
4. Low current noise

■ Application

1. Current sensor
2. Medical equipment
3. Measuring instrument
4. Communication device
5. Computer
6. Printer.

■ Thin Film Low Ohmic TC100 WWxxG Series (E192+E24 series)

Series No.	WW25G	WW20G	WW10G	WW12G	WW08G	WW06G	WW04G
Size Code	2512 (6432)	2010(5025)	1210(3225)	1206(3216)	0805(2012)	0603(1608)	0402(1005)
Resistance Tolerance	±5.0%, ±2.0%, ±1%						
Resistance Range	5mΩ ~ 900mΩ						
TCR	±100 ppm/°C						
Max. Dissipation at T _{amb} =70°C	2W	1W	1/2W	1/2W	1/4W	1/8W	1/10W
Max. Operation Voltage	250V	200V	200V	200V	200V	50V	50V
Operation Temperature	-55 ~ +155°C						

■ Thin Film Low Ohmic TC75 WWxxF Series (E192+E24 series)

Series No.	WW25F	WW20F	WW10F	WW12F	WW08F	WW06F	WW04F
Size Code	2512 (6432)	2010(5025)	1210(3225)	1206(3216)	0805(2012)	0603(1608)	0402(1005)
Resistance Tolerance	±5.0%, ±2.0%, ±1%						
Resistance Range	101mΩ ~ 900mΩ						
TCR	±75 ppm/°C						
Max. Dissipation at T _{amb} =70°C	2W	1W	1/2W	1/2W	1/4W	1/8W	1/10W
Max. Operation Voltage	250V	200V	200V	200V	200V	50V	50V
Operation Temperature	-55 ~ +155°C						
Basic Specification	JIS C5201-1 / IEC 60115-1						

(Detail specification please refer to specific data sheets)

■ MELF: Thin Film / Metal Film - WM Series

■ Feature

1. SMD enabled structure thin film resistor
2. High reliability and stability of $\pm 0.5\%$ and below per customer request
3. Power rating up to 1Watt.
4. Best in class pulse load capability.

■ Application

1. Medical equipment
2. Measuring instrument
3. Power / Meter Converter.

■ Thin Film Metal MELF TC50 WMxxB / WMxxN (Power) Series (E192+E24 series)

Series No.	WM07B	WM04B	WM07N	WM04N
Size code	0207 (6123)	0204 (3715)	0207 (6123)	0204 (3715)
Resistance Tolerance	$\pm 1\%, \pm 0.5\%, \pm 0.25\%, \pm 0.1\%$		$\pm 1\%, \pm 0.5\%, \pm 0.25\%, \pm 0.1\%$	
Resistance Range	0.22 Ω ~ 10M Ω		0.22 Ω ~ 10M Ω	
TCR (ppm/ $^{\circ}$ C)	± 50 ppm/ $^{\circ}$ C			
Max. dissipation at $T_{amb}=70^{\circ}$ C	1/2W	1/4W	1W	2/5W
Max. Operation Voltage (DC or RMS)	300V	200V	350V	200V
Operation temperature	- 55 ~ +125 $^{\circ}$ C		- 55 ~ +155 $^{\circ}$ C	
Basic Specification	JIS C5201-1 / IEC 60115-1			

■ Thin Film Metal MELF TC25 WMxxC / WMxxO (Power) Series (E192+E24 series)

Series No.	WM07C	WM04C	WM07O	WM04O
Size code	0207 (6123)	0204 (3715)	0207 (6123)	0204 (3715)
Resistance Tolerance	$\pm 1\%, \pm 0.5\%, \pm 0.25\%, \pm 0.1\%$		$\pm 1\%, \pm 0.5\%, \pm 0.25\%, \pm 0.1\%$	
Resistance Range	10 Ω ~ 1M Ω		10 Ω ~ 1M Ω	
TCR (ppm/ $^{\circ}$ C)	± 25 ppm/ $^{\circ}$ C			
Max. dissipation at $T_{amb}=70^{\circ}$ C	1/2W	1/4W	1W	2/5W
Max. Operation Voltage (DC or RMS)	300V	200V	350V	200V
Operation temperature	- 55 ~ +125 $^{\circ}$ C		- 55 ~ +155 $^{\circ}$ C	

■ Thin Film Metal MELF TC15 WMxxD / WMxxP (Power) Series (E192+E24 series)

Series No.	WM07D	WM04D	WM07P	WM04P
Size code	0207 (6123)	0204 (3715)	0207 (6123)	0204 (3715)
Resistance Tolerance	$\pm 1\%, \pm 0.5\%, \pm 0.25\%, \pm 0.1\%$		$\pm 1\%, \pm 0.5\%, \pm 0.25\%, \pm 0.1\%$	
Resistance Range	49.9 Ω ~ 221K Ω		49.9 Ω ~ 221K Ω	
TCR (ppm/ $^{\circ}$ C)	± 15 ppm/ $^{\circ}$ C			
Max. dissipation at $T_{amb}=70^{\circ}$ C	1/2W	1/4W	1W	2/5W
Max. Operation Voltage (DC or RMS)	300V	200V	350V	200V
Operation temperature	- 55 ~ +125 $^{\circ}$ C		- 55 ~ +155 $^{\circ}$ C	
Basic Specification	JIS C5201-1 / IEC 60115-1			

(Detail specification please refer to specific data sheets)

■ Test and Requirements

■ For WR Series

Test	Procedure / Test Method	Requirements	
		Resistor	0Ω
Electrical Characteristics JISC5201-1: 1998 Clause 4.8	- DC resistance values measurement - Temperature Coefficient of Resistance (T.C.R) Natural resistance change per change in degree centigrade. $R2-R1/R1(T2-T1) \times 10^6$ (ppm/°C) T1:20°C+5°C-1°C R1:Resistance at reference temperature (20°C+5°C/-1°C) R2:Resistance at test temperature (-55°C or +155°C)	Within the specified tolerance Refer to "QUICK REFERENCE DATA"	< 50mΩ
Resistance to soldering heat(R.S.H) JISC5201-1:1998 Clause 4.18	Un-mounted chips completely immersed for 10±1second in a SAC solder bath at 260°C±5°C	±5%: $\Delta R/R_{max}$. (1%+0.05Ω) ±1%: $\Delta R/R_{max}$. (0.5%+0.05Ω) no visible damage	< 50mΩ
Solderability JISC5201-1:1998 Clause 4.17	Un-mounted chips completely immersed for 2±0.5 second in a SAC solder bath at 235°C±5°C	95% coverage min., good tinning and no visible damage	
Temperature cycling JISC5201-1:1998 Clause 4.19	30minutes at -55°C±3°C, 2~3minutes at 20°C+5°C-1°C,30minutes at +155°C±3°C,2~3minutes at 20°C+5°C-1°C,total 5continuous cycles	±5%: $\Delta R/R_{max}$. (1%+0.05Ω) ±1%: $\Delta R/R_{max}$. (0.5%+0.05Ω) no visible damage	< 50mΩ
High Temperature Exposure MIL-STD-202 Method 108	1000+48/-0 hours; without load in a temperature chamber controlled 155°C±3°C	±5%: $\Delta R/R_{max}$. (2%+0.1Ω) ±1%: $\Delta R/R_{max}$. (1%+0.1Ω) no visible damage	< 50mΩ
Bending strength JISC5201-1:1998 Clause 4.33	Resistors mounted on a 90mm glass epoxy resin PCB(FR-4), bending once 3mm for 10sec, 5mm for WR04	±5%: $\Delta R/R_{max}$. (1%+0.05Ω) ±1%: $\Delta R/R_{max}$. (1%+0.05Ω) no visible damage	< 50mΩ
Adhesion JISC5201-1:1998 Clause 4.32	Pressurizing force: 5N, Test time: 10±1sec.	No remarkable damage or removal of the terminations	
Short Time Overload (STOL) JISC5201-1:1998 Clause 4.13	2.5 times RCWV or max. overload voltage, for 5seconds	±5%: $\Delta R/R_{max}$. (2%+0.1Ω) ±1%: $\Delta R/R_{max}$. (1%+0.1Ω) no visible damage	< 50mΩ
Load life in Humidity JISC5201-1:1998 Clause 4.24	1000+48/-0 hours, loaded with RCWV or Vmax in humidity chamber controller 40°C±2°Cat and 90~95% relative humidity, 1.5 hours on and 0.5 hours off	±5%: $\Delta R/R_{max}$. (2%+0.1Ω) ±1%: $\Delta R/R_{max}$. (1%+0.1Ω) no visible damage	< 50mΩ
Load life (endurance) JISC5201-1:1998 Clause 4.25	1000+48/-0 hours, loaded with RCWV or Vmax in chamber controller 70°C±2°C 1.5 hours on and 0.5 hours off	±5%: $\Delta R/R_{max}$. (2%+0.1Ω) ±1%: $\Delta R/R_{max}$. (1%+0.1Ω) no visible damage	< 50mΩ
Insulation Resistance JISC5201-1:1998 Clause 4.6	Apply the maximum overload voltage (DC) for 1minute	$R \geq 10G\Omega$	
Dielectric Withstand Voltage JISC5201-1:1998 Clause 4.7	Apply the maximum overload voltage (AC) for 1minute	No breakdown or flashover	

■ Test and Requirements

■ For WW Series

Test	Procedure / Test Method	Requirements
		Resistor
Electrical Characteristics JISC5201-1: 1998 Clause 4.8	- DC resistance values measurement - Temperature Coefficient of Resistance (T.C.R) Natural resistance change per change in degree centigrade. $R2-R1/R1(T2-T1) \times 10^6$ (ppm/°C) T1:20°C+5°C-1°C R1:Resistance at reference temperature (20°C+5°C/-1°C) R2:Resistance at test temperature (-55°C or +155°C)	Within the specified tolerance Refer to "QUICK REFERENCE DATA"
Resistance to soldering heat(R.S.H) JISC5201-1:1998 Clause 4.18	Un-mounted chips completely immersed for 10±1second in a SAC solder bath at 260°C±5°C	ΔR/R max. ±(1%+0.005Ω) no visible damage
Solderability JISC5201-1:1998 Clause 4.17	Un-mounted chips completely immersed for 2±0.5 second in a SAC solder bath at 235°C±5°C	95% coverage min., good tinning and no visible damage
Temperature cycling JISC5201-1:1998 Clause 4.19	30minutes at -55°C±3°C, 2~3minutes at 20°C+5°C-1°C,30minutes at +155°C±3°C,2~3minutes at 20°C+5°C-1°C,total 5continuous cycles	ΔR/R max. ±(1%+0.005Ω) no visible damage
High Temperature Exposure MIL-STD-202 Method 108	1000+48/-0 hours; without load in a temperature chamber controlled 155°C±3°C	ΔR/R max. ±(3%+0.005Ω) no visible damage
Bending strength JISC5201-1:1998 Clause 4.33	Resistors mounted on a 90mm glass epoxy resin PCB(FR-4), bending once 3mm for 10sec, 5mm for WR04	ΔR/R max. ±(1%+0.005Ω) no visible damage
Adhesion JISC5201-1:1998 Clause 4.32	Pressurizing force: 5N, Test time: 10±1sec.	No remarkable damage or removal of the terminations
Short Time Overload (STOL) JISC5201-1:1998 Clause 4.13	2.5 times RCWV or max. overload voltage, for 5seconds	ΔR/R max. ±(2%+0.005Ω) no visible damage
Load life in Humidity JISC5201-1:1998 Clause 4.24	1000+48/-0 hours, loaded with RCWV or Vmax in humidity chamber controller 40°C±2°Cat and 90~95% relative humidity, 1.5 hours on and 0.5 hours off	ΔR/R max. ±(3%+0.005Ω) no visible damage
Load life (endurance) JISC5201-1:1998 Clause 4.25	1000+48/-0 hours, loaded with RCWV or Vmax in chamber controller 70°C±2°C 1.5 hours on and 0.5 hours off	ΔR/R max. ±(3%+0.005Ω) no visible damage
Insulation Resistance JISC5201-1:1998 Clause 4.6	Apply the maximum overload voltage (DC) for 1minute	$R \geq 10G\Omega$
Dielectric Withstand Voltage JISC5201-1:1998 Clause 4.7	Apply the maximum overload voltage (AC) for 1minute	No breakdown or flashover

■ Test and Requirements

■ For MF Series (Auto Grade/AEC-Q200/Thin Film)

Test	Procedure / Test Method	Requirements
		Resistor
Electrical Characteristics IEC 60115-1 4.8	- DC resistance values measurement - Temperature Coefficient of Resistance (T.C.R) Natural resistance change per change in degree centigrade. (ppm/°C) $t_1 : 20^{\circ}\text{C}+5^{\circ}\text{C}-1^{\circ}\text{C}$ $\frac{R_2 - R_1}{R_1 (t_2 - t_1)} \times 10^6$ R_1 : Resistance at reference temperature ($20^{\circ}\text{C}+5^{\circ}\text{C}-1^{\circ}\text{C}$) R_2 : Resistance at test temperature (-55°C or $+125^{\circ}\text{C}$)	Within the specified tolerance
Short time overload (S.T.O.L) IEC60115-1 4.13	Permanent resistance change after a 5second application of a voltage 2.5 times RCWV or the maximum overload voltage specified in the above list, whichever is less.	$\Delta R/R$ max. $\pm(0.1\%+0.02\Omega)$
Resistance to soldering heat(R.S.H) AEC Q200-15	Un-mounted chips completely immersed for 10 ± 1 second in a SAC solder bath at $260^{\circ}\text{C} \pm 5^{\circ}\text{C}$	no visible damage $\Delta R/R$ max. $\pm(0.1\%+0.02\Omega)$
Solderability IEC 60068-2-58	Un-mounted chips completely immersed for 2 ± 0.5 second in a SAC solder bath at $235^{\circ}\text{C} \pm 5^{\circ}\text{C}$	good tinning (>95% covered) no visible damage
Thermal Shock MIL-STD-202 Method 107	Test -55 to 125°C / dwell time 15min/ Max transfer time 20sec 1000 cycles	no visible damage $\Delta R/R$ max. $\pm(0.1\%+0.02\Omega)$
Bias Humidity AEC Q200-7	1000 +48/-0 hours, loaded with 10% rated power in humidity chamber controller at $+85^{\circ}\text{C}$ / 85%RH	$\Delta R/R$ max. $\pm(0.1\%+0.02\Omega)$
Load Life IEC60115-1 4.25	1000 +48/-0 hours, loaded with RCWV or Vmax in chamber controller $85 \pm 2^{\circ}\text{C}$, 1.5 hours on and 0.5 hours off	$\Delta R/R$ max. $\pm(0.1\%+0.02\Omega)$
Operational Life AEC Q200-8 MIL-STD-202 -108	1,000 hours at $125\pm 2^{\circ}\text{C}$, loaded with rated power continuously	$\Delta R/R$ max. $\pm(0.1\%+0.02\Omega)$
High Temperature Exposure AEC Q200-3	1000 hrs @ 125°C , un-powered	$\Delta R/R$ max. $\pm(0.1\%+0.02\Omega)$
Moisture Resistance AEC-Q200 -6 MIL-STD-202 Method 106	$65\pm 2^{\circ}\text{C}$, 80~100% RH, 10 cycles, 24 hours/ cycle	$\Delta R/R$ max. $\pm(0.1\%+0.02\Omega)$
Mechanical Shock MIL-STD-202 Method 213	1/2 Sine Pulse / 1500g Peak / Velocity 15.4ft/sec	$\Delta R/R$ max. $\pm(0.1\%+0.02\Omega)$
Vibration MIL-STD-202 Method 204	5 g's for 20 min , 12 cycles each of 3 orientations	$\Delta R/R$ max. $\pm(0.1\%+0.02\Omega)$
Terminal strength AEC-Q200-6	1 kg for 60 s	No broken
Board flex AEC-Q200-21	Bending 2mm for 60 sec	$\Delta R/R$ max. $\pm(0.1\%+0.02\Omega)$

■ **Packing on Tape and Reel: All specifications are in accordance with IEC 60286-3**

■ **Paper Tape Specifications for WR, WF, WW Series and WA, WT, TA Series**

Unit: mm

Component Size / Series	W	F	E	PO	ΦD
1210, 1206, 0805, 0603, 0402, WA06X, WA06T, WA04X, WA04Y, WA04P, WA04T, WA04U, WT04X	8.00±0.30	3.50±0.20	1.75±0.10	4.00±0.10	Φ1.50+0.1
WA06W	12.0±0.10	5.50±0.05			
WR02X	8.00±0.20	3.50±0.05			

Component Size / Series	A	B	P1	T
1206(3216), WA06X, WA06T	3.60±0.20	2.00±0.20	4.00±0.10	Max. 1.0
0805(2012)	2.40±0.20	1.65±0.20		Max. 0.6
0603(1608)	1.90±0.20	1.10±0.20		0.65±0.05
0402(1005)	1.20±0.10	0.70±0.10	2.00±0.10	0.40±0.05
WA04X, WA04T	2.20±0.20	1.20±0.20	2.00±0.05	Max. 0.6
WA04Y, WA04P, WA04U	1.15±0.10	1.15±0.10	2.00±0.05	0.45±0.05
WT04X	3.45+0.2/-0	1.85+0.2/-0	4.00±0.10	0.85±0.05
WA06W	4.20+0.2/-0	1.80+0.2/-0	4.00±0.10	0.65±0.05
WR02X	0.67±0.05	0.37±0.05	2.00±0.05	0.45±0.05
1210(3225)	3.60±0.20	3.00±0.20	4.00±0.10	Max. 1.0

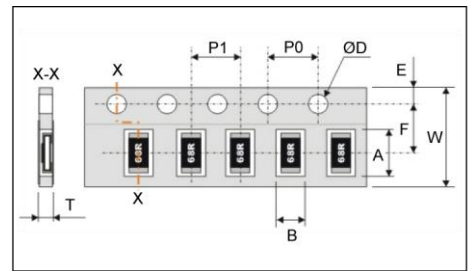
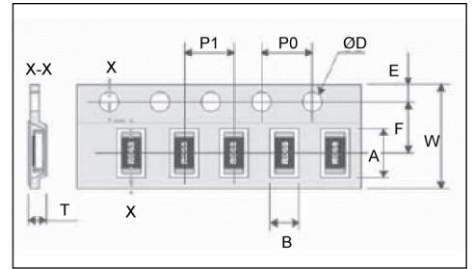
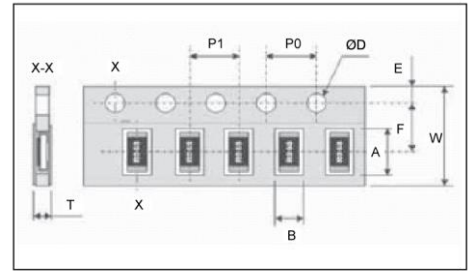

■ **Plastic Tape Specifications for WR, WF, WW, WM Series of Chip-R**

Unit: mm

Component Size	2512(6432)	2010(5025)	1218(3248)
A	6.90±0.20	5.50±0.20	3.55±0.30
B	3.60±0.20	2.80±0.20	4.90±0.20
W	12.00±0.30		
F	5.50±0.10		
E	1.75±0.10		
P1	4.00±0.10	8.00±0.10	
P0	4.00±0.10		
ΦD	Φ1.50+0.1		
T	Max. 1.2		

Component Size	0207 (6123)	0204 (3715)
A	6.15±0.10	3.65±0.10
B	2.40±0.10	1.55±0.10
W	12.00±0.30	8.00±0.30
F	5.50±0.05	3.50±0.05
E	1.75±0.10	1.75±0.10
P1	4.00±0.10	4.00±0.10
P0	4.00±0.10	4.00±0.10
ΦD	Φ1.50+0.1	Φ1.50+0.1
T	2.70±0.10	1.8±0.10

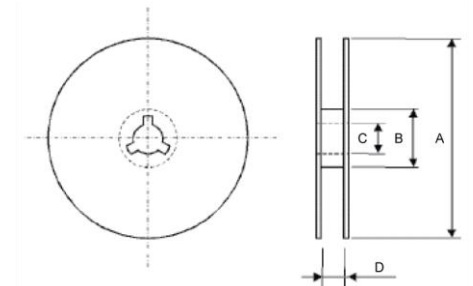

■ **Plastic Tape Reel Specifications for WR, WF, WW, WM Series of Chip-R**

Unit: mm

Reel/Tape	A	B	C	D
7" reel for 8mm tape	Φ178.0±0.20	Φ60.0±1.00	13.0±0.20	9.00±0.50
7" reel for 12mm tape				12.4+2.0/-0
10" reel for 8mm tape	Φ254.0±2.00	Φ100.0±1.00	13.0±0.20	9.00±0.50
10" reel for 12mm tape	Φ254.0±2.00	Φ100.0±1.00	13.0±0.20	12.4+2.0/-0
13" reel for 8mm tape	Φ330.0±2.00	Φ100.0±1.00	13.0±0.20	9.00±0.50

■ **Reel Taping Quantity Specifications for WR, WF, WW, WM Series and WA, WT, TA Series**

Unit: mm

Component Size / Series	Q'ty per reel	Reel Diameter
0603, 0805, 1206	1,000 pcs	4" reel
1210, 1206, 0805, 0603, WA06X, WA06T, WT04X	5,000 pcs	7" reel
0201, 0402, WA04X, WA04Y, WA04P, WA04T, WA04U	10,000 pcs	7" reel
0201, 0402	15,000 pcs	7" reel
WA06X, WA06Y	5,000 pcs	7" reel
2512, 2010	4,000 pcs	7" reel
WM'0207	3,000 pcs	7" reel
WM'0204	2,000 pcs	7" reel
1218	3,000 pcs	10" reel
1210, 1206, 0805, 0603, WA06X, WA06T	10,000 pcs	10" reel
0201, 0402, WA04X, WA04Y	Q: 20,000 pcs/ J: 40,000 pcs	10" reel
2010, 2512	8,000 pcs	10" reel
0201	H: 50,000pcs/ G: 70,000 pcs	13" reel
0402	H: 50,000pcs/ G: 70,000 pcs	13" reel
WA04X, WA04Y	40,000 pcs	13" reel
1210, 1206, 0805, 0603, WA06X,	20,000 pcs	13" reel
2010, 2512	16,000 pcs	13" reel

■ Footprint Design

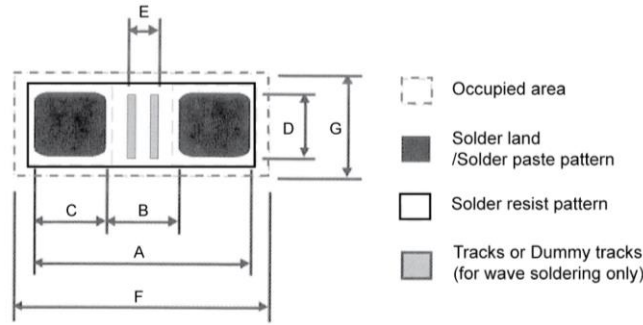

■ Footprint Design for WRxx, WFxx, WWxx Series

Size	Reflow Soldering							Processing Remarks	Placement Accuracy
	A	B	C	D	E	F	G		
01005	0.58	0.18	0.20	0.20	0.10	0.90	0.40	IR or hot plate soldering	±0.03
0201	0.90	0.30	0.30	0.30	0.20	1.10	0.50		±0.05
0402	1.50	0.50	0.50	0.60	0.10	1.90	1.00		±0.15
0603	2.10	0.90	0.60	0.90	0.50	2.35	1.45		±0.25
0805	2.60	1.20	0.70	1.30	0.75	2.85	1.90		±0.25
1206	3.80	2.00	0.90	1.60	1.60	4.05	2.25		±0.25
1210	3.80	2.00	0.90	2.80	1.60	4.05	3.15		±0.25
1218	3.80	2.00	0.90	4.80	1.40	4.20	5.50		±0.25
2010	5.60	3.80	0.90	2.80	3.40	5.85	3.15		±0.25
2512	7.00	3.80	1.60	3.50	3.40	7.25	3.85		±0.25

Size	Wave Soldering							Processing Number & Dimensions of dummy tracks	Placement Accuracy
	A	B	C	D	E	F	G		
0603	2.70	0.90	0.90	0.80	0.15	3.40	1.90	1× (0.15 × 0.80)	±0.25
0805	3.40	1.30	1.05	1.30	0.20	4.30	2.70	1× (0.20 × 1.30)	±0.25
1206	4.80	2.30	1.25	1.70	1.25	5.90	3.20	3× (0.25 × 1.70)	±0.25
1210	4.80	2.30	1.25	2.50	1.25	5.90	3.60	3× (0.25 × 4.80)	±0.25
1218	4.80	2.30	1.25	4.80	1.30	5.90	5.60	3× (0.25 × 4.80)	±0.25
2010	6.30	3.50	1.40	2.50	3.00	7.00	3.60	3× (0.75 × 2.50)	±0.25
2512	8.50	4.50	2.00	3.20	3.00	9.00	4.30	3× (1.00 × 3.20)	±0.25

■ Footprint Design for Array Resistor/Attenuator

Symbol	Array Resistor/Attenuator						
	0603x4 array	0603x2 array	0402x4 array	0402x2 array	0402x8 array	WA02A	WA02B
A	3.0+0.10/-0.05	1.5+0.10/-0.05	1.80±0.05	1.20±0.05	3.85±0.05	1.40±0.05	0.80±0.05
B	0.45±0.05	0.45±0.05	0.30±0.05	0.40 +0/-0.05	0.28 +0/-0.05	0.20 +0/-0.05	0.30 +0/-0.05
D	0.80±0.10	0.80±0.10	0.50±0.10	0.50±0.05	1.00 +0.1/-0.20	0.30±0.05	0.30±0.05
P	0.8	1.0	0.5	0.65	0.5	0.4	0.5
F	1.90±0.20	1.80±0.20	1.3 +0.20/-0.10	1.3 +0.20/-0.10	1.90±0.20	0.9±0.10	0.9±0.10

■ Footprint Design for 10P8R Network Resistor

Symbol	WT04X
W1	0.50±0.05
W2	0.35±0.05
H2	0.80±0.10
P1	0.70±0.05
P2	0.65±0.05
A	3.20±0.10
F	2.80 + 0.40 / -0.20

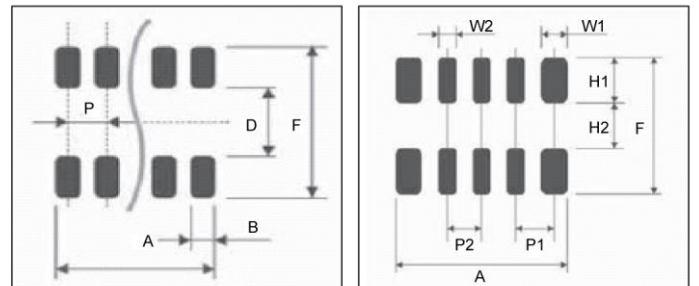

■ Storage and Handling Conditions

1. Products are recommended to be used up within two years since production as ensured shelf life . Check solderability in case shelf life extension is needed.
2. To store products with following condition:
 - Temperature :5 to 40°C
 - Humidity :20 to 70% relative humidity
3. Caution:
 - a. Don't store products in a corrosive environment such as sulfide, chloride gas, or acid. It may cause oxidization of electrode, which easily be resulted in poor soldering
 - b. To store products on the shelf and avoid exposure to moisture.
 - c. Don't expose products to excessive shock, vibration, direct sunlight and so on

■ Precaution of Soldering

1. It is recommended to use a mildly activated rosin flux (less than 0.1% wt chlorine)
2. Excessive flux must be avoided
3. When water-soluble flux is used, enough washing is necessary
4. Two times limitations for reflow soldering is highly recommended
5. Solder repair by soldering iron
 - a. Max. 350°C for below 3 seconds is highly recommended
 - b. Do not directly contact termination to avoid thermal shock
6. Prevent any external force on the products until solder is cooled

■ Mounting

1. Imperfect adjustment of mounting machine may cause the cracks, the chipping and the alignment error. Check and inspect the mounting machine in advance.
2. Set the backup pins in proper layout otherwise the components mounted on the backside of the board are damaged. Do not set these pins at the position of the nozzle.
3. Adjust the bottom dead point of dispenser away from the board when you apply adhesive.
4. Confirm that the products are corresponding to flow soldering when you perform it.
5. Pay attention to the amount of solder because improper amount of solder place large stress on the products and cause cracks or malfunctions.

■ Washing

1. Confirm the ionic residues in solder do not remain after washing for moisture resistance and corrosion. Resistance may cause deterioration when these substances are attached to the products.
2. Confirm the reliability in advance when using no washing solder, water or soluble agent.
3. Wash thoroughly after soldering to remove ionic substances like sweat and salinity.
4. The ultrasonic washing may destruct the products due to resonance by vibration. High hydraulic pressure may also damage the products.
5. Dry the products sufficiently after washing.

■ Recommendation of Soldering Profiles

In general application, the lead free (Pb-free) termination CRs are used and may be mounted on PCB by IR reflow or wave soldering process with lead-free solder material. The recommended soldering profiles are shown as Fig.1 & 2. The lead-free termination CRs are also suitable on SMT process against lead-containing solder paste. But the soldering temperature should be higher than the melting point of solder paste 30°C at least. If the optimized solder joint is requested, increasing soldering time, temperature and concentration of N₂ within oven are recommended. Advised IR reflow soldering profile is shown as Fig.3.

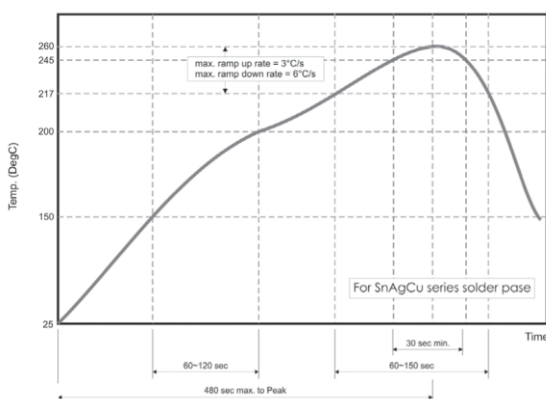

Fig. 1 Recommended IR reflow soldering profile for SMT process with SnAgCu series solder paste

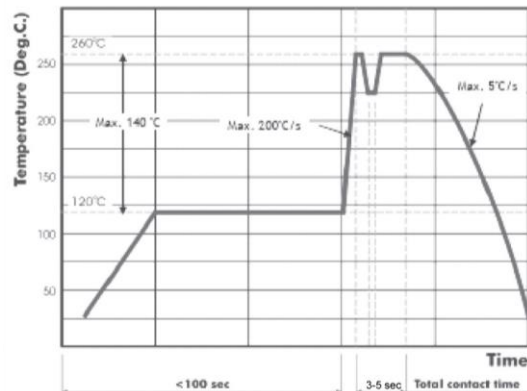

Fig. 2 Recommended wave soldering profile for SMT process with SnAgCu series solder

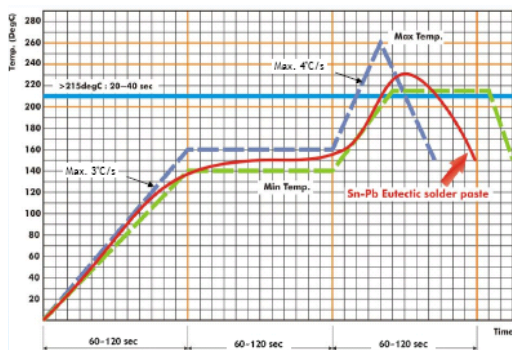

Fig. 3 Recommended reflow soldering profile for SMT process with eutectic SnPb solder paste.

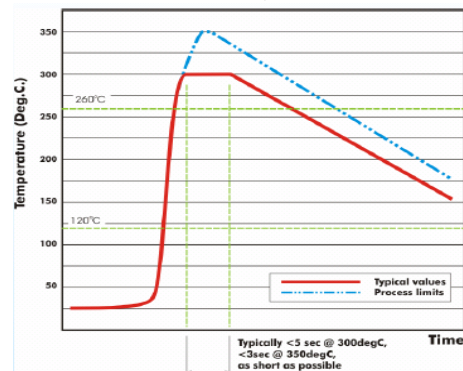

Fig. 4 Recommended soldering profile by manual with SnAgCu series solder material

Taiwan - Yang-Mei Plant / Sales Office

Walsin Technology Corporation
566-1, Kao-Shi Road, Yang-Mei,
Tao-Yuan, Taiwan
Tel: +886-3-475-8711
Fax: +886-3-475-7130
Email: info@passivecomponent.com

China - Dalang Plant / Sales Office

Dongguan Walsin Tech. Electronics CO., Ltd.
Xiniupo Administrative Zone,
Dalang Town, Dongguan City,
Guangdong Province 523799
Tel: +86-769-831-15168
Fax: +86-769-831-15188
Email: msyu@passivecomponent.com

China - Suzhou Plant / Sales Office

Suzhou Walsin Technology Electronics Co., Ltd.
No. 369, Changyan Street,
Suzhou Industrial Park,
Jiangsu Province 215126
Tel: +86-512-628-36888
Fax: +86-512-628-37888
Email: msyu@passivecomponent.com

China - Guangzhou Plant / Sales Office

Pan Overseas (Guangzhou) Electronic Co., Ltd.
No. 277, Hong Ming Road, Eastern Section,
Guangzhou Economic and Technology
Development Zone, China
Tel: +86-20-8223-7476
Fax: +86-20-8223-7475
Email: msyu@passivecomponent.com

Germany - Munich Sales Office

Walsin Technology Corporation Europe
Stefan-George-Ring 29,
81929 Munich, Germany
Tel: +49-(0)89-9308-6475
Fax: +49-(0)89-9308-6464
Email: aw@passivecomponent.com

Singapore - Sales Office

WTC Singapore Sales Office, Singapore
24 Sin Ming Lane Midview City
#04-100, Singapore 573970
Contact: Morris Liew
Tel: +65-6262 3997
Email: morrisliew@sg.passivecomponent.com

Malaysia - Sales Office

Walsin Technology Corporation, Malaysia
1st Floor, No.19, Jalan Puteri 5/8,
Bandar Puteri Puchong, Puchong,
47100, Selangor, Malaysia
Contact: Arthur Ling
Tel : +6016-2217-948
Fax : +603-8051-7060
Email : arthurling@passivecomponent.com

United States - West Coast Sales Office

Walsin Technology Corporation, USA
Contact: FC Tseng
Tel: +1-214-708-5182
E-mail: fctsen@passivecomponent.com

JAPAN - Sales Office

PSA BLDG. 3F, 6-1-6 Chuou,
Yamato-Shi, Kanagawa,
242-0021 Japan
Tel:+81-46-204-8829
Fax:+81-46-204-8955
Email: tsakano@kamaya.co.jp

PSA

Walsin Technology Corporation

TAIWAN - WTC Yang-Mei Plant / Sales Office

566-1, Kao-Shi Road, Yang-Mei, Tao-Yuan, Taiwan

Tel: +886-3-475-8711

Fax: +886-3-475-7130

Email: info@passivecomponent.com



July 2017