

<http://www.wima.com>

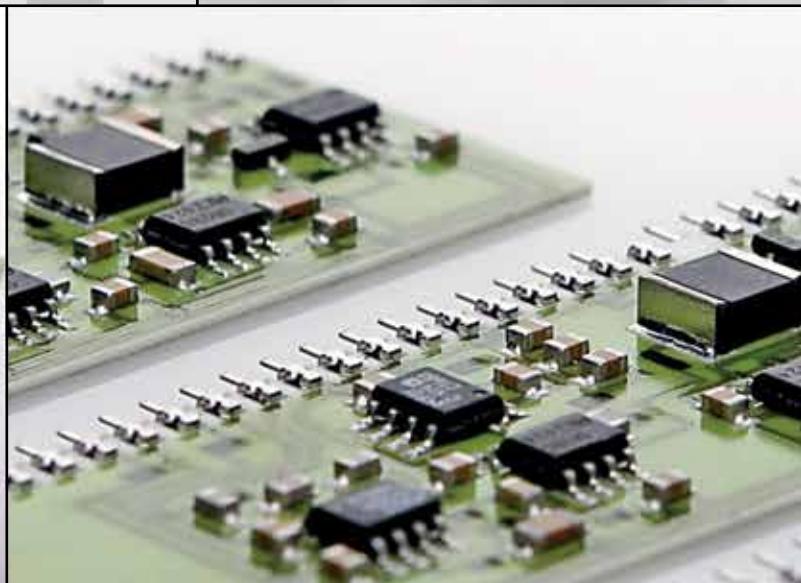

MADE IN GERMANY

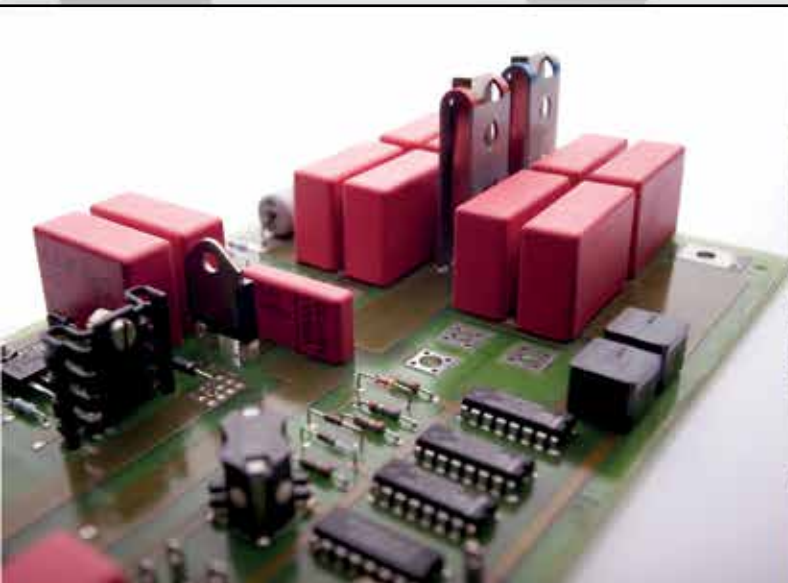
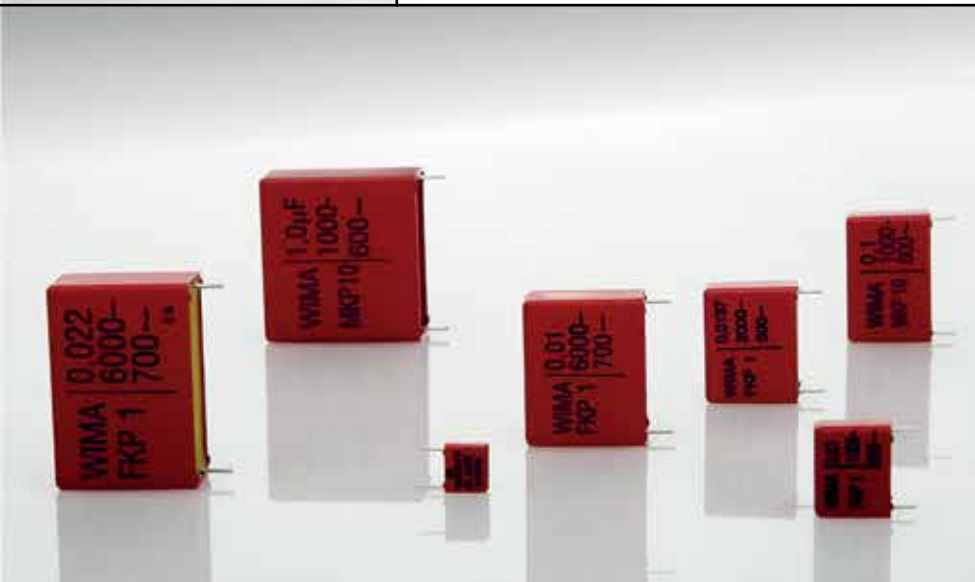

Film Capacitors for Electronic Equipment

Edition 2016



■ SMD Plastic Film Capacitors Size Codes 1812 to 6054	Polyester film, metallized		WIMA SMD-PET	17
	Polyethylene-naphthalate film, metallized		WIMA SMD-PEN	20
	Polyphenylene-sulphide film, metallized		WIMA SMD-PPS	23
■ Subminiature Capacitors PCM 2.5 mm	Polypropylen film, film/foil		WIMA FKP 02	27
	Polyester film, metallized		WIMA MKS 02	29
■ Film/Foil Capacitors PCM 5 mm	Polyester film, film/foil		WIMA FKS 2	32
	Polypropylene film, film/foil		WIMA FKP 2	34
■ Film/Foil Capacitors PCM 7.5 to 15 mm	Polyester film, film/foil		WIMA FKS 3	37
	Polypropylene film, film/foil		WIMA FKP 3	40
■ Metallized Capacitors PCM 5 mm	Polyester film, metallized		WIMA MKS 2	44
	Polypropylene film, metallized		WIMA MKP 2	47
■ Metallized Capacitors PCM 7.5 to 52.5 mm	Polyester film, metallized		WIMA MKS 4	50
	Polypropylene film, metallized		WIMA MKP 4C	56
	Polypropylene film, metallized		WIMA MKP 4	59
■ Pulse Duty Capacitors PCM 7.5 to 52.5 mm	Polypropylene film, double-sided metallized electrode		WIMA MKP 10	64
	Polypropylene film, metal foil/double-sided metallized film		WIMA FKP 1	70
■ Polypropylene RFI-Capacitors PCM 7.5 to 37.5 mm	Polypropylene film, metallized	Class X2	WIMA MKP-X2	76
	Polypropylene film, metallized	Class X1	WIMA MKP-X1 R	80
	Polypropylene film, metallized	Class Y2	WIMA MKP-Y2	84
■ Metallized Paper RFI-Capacitors PCM 10 to 27.5 mm	Capacitor paper, metallized	Class X2	WIMA MP 3-X2	87
	Capacitor paper, metallized	Class X1	WIMA MP 3-X1	89
	Capacitor paper, metallized	Class Y2	WIMA MP 3-Y2/3R-Y2	91
■ Filter Capacitors	Polypropylene film, metallized		WIMA MKP 4F	94
■ Snubber Capacitors	Polypropylene film, double-sided metallized electrode		WIMA Snubber MKP	101
	Polypropylene film, metal foil/metallized film		WIMA Snubber FKP	105
■ GTO Capacitors	Polypropylene film, double-sided metallized electrode		WIMA GTO MKP	112
■ DC-LINK Capacitors	Polypropylene film, metallized		WIMA DC-LINK MKP 3	117
	Polypropylene film, metallized		WIMA DC-LINK MKP 4	119
	Polypropylene film, metallized		WIMA DC-LINK MKP 4S	125
	Polypropylene film, metallized		WIMA DC-LINK MKP 5	129
	Polypropylene film, metallized		WIMA DC-LINK MKP 6	131
	Polypropylene film, metallized		WIMA DC-LINK HC	137
	Polypropylene film, metallized		WIMA DC-LINK HY	139
■ PowerBlock	Double-Layer capacitor (SuperCap) modules		WIMA PowerBlock	141
■ General Information	Explanation of important terminology			3
	Construction principles of WIMA film and paper capacitors			4
	Typical characteristics and graphs of the plastic film dielectric used			5
	Technical data and advantages of WIMA capacitors			9
	Selection of WIMA capacitors for pulse applications			11
	Recommendation for processing and application of WIMA capacitors			13
	WIMA quality and environmental philosophy			15
	WIMA part number system			143
	Types of packaging and packing units for WIMA capacitors			144
WIMA representations			149	

General Information

Explanation of Important Terminology

Nominal Capacitance

The nominal capacitance of a capacitor is usually given in pF, nF or μF .

Operating/Rated Voltage

Each capacitor is designed for a specified rated voltage in continuous operation. This is usually only valid for ambient temperatures of $T \leq +85^\circ\text{C}$. In the case of higher temperatures a derating factor must be applied to the rated voltage from 85°C .

Insulation Resistance/Time Constant

The insulation resistance is normally expressed in megohms ($M\Omega$) and is measured at a specified voltage after 1 minute. The time constant defines the time in seconds, in which the voltage across the capacitor self-discharges to 37% of the fully charged state and it is expressed as $\tau = R_{is} \times C$. The insulation resistance or time constant value denotes the quality of the dielectric insulation.

Dissipation Factor

The dissipation factor $\tan \delta$ is the quotient of the resistive and reactive parts of the impedance. The dielectric losses are illustrated by R in the equivalent circuit diagram. The insulation resistance R_{is} is in parallel with R, and affects the $\tan \delta$ only at very low frequencies. The dissipation factor is also affected by the resistance of both electrodes and of the termination – electrode interface. This is represented by the series resistance r. L represents the remaining self-inductance.

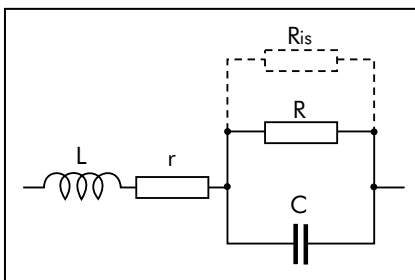

Capacitance Tolerance

The tolerance is the permissible actual capacitance relative to the nominal capacitance and it is defined in per cent. The tolerance is to be measured at $+20^\circ\text{C}$ and the permissible tolerance is only valid at the time of shipment.

The capacitance may change after long storage or long usage.

The tolerance, with the exception of $\pm 20\%$, is usually marked on the capacitor body in clear digits.

Temperature Coefficient of Capacitance

The temperature coefficient α expresses the change in capacitance with temperature, relative to the capacitance at the reference temperature of $+20^\circ\text{C}$; it is usually expressed in ppm per $^\circ\text{C}$.

$$C_T = C_{20} \times [1 + \alpha \times (T - 20^\circ\text{C})]$$

C_{20} = capacitance at $+20^\circ\text{C}$

C_T = capacitance at T

α = may be positive or negative.

Pulse Stressing

The ratings on pulse rise time are based on tests in accordance with DIN-IEC 60384 part 1.

The test voltage corresponds to the rated voltage and the test comprises 10 000 pulses with a repetition frequency of 1 Hz.

The catalogue ratings are in accordance with the CECC specifications which specify that the test pulse rise time shall be 10 times the catalogue rating.

It should also be noted that the pulse rise time (F) i.e. $V/\mu\text{sec}$ also provides the maximum current capability, as it can be determined from the following formula.

$$I = F \times C \times 1.6$$

C in μF / I in amps.

The information on the pulse rise time refers to pulses equal to the rated voltage so that, at lower operating voltages, the permissible pulse rise times may be increased.

Warning Notice/Technical Support

AC voltage load at the mains

Anticipating possible interfering pulses, DC

voltage capacitors must not be operated at the mains (power line), irrespective of the rated AC voltage. For this purpose, use approved electromagnetic interference suppression capacitors only.

Thermal load in the application

If a plastic film capacitor is overstressed due to inappropriate usage under AC voltage conditions, the temperature inside the component may rise to an impermissibly high level. Thus, the dielectric film may subsequently be damaged leading to a short circuit or formation of smoke and even fire in the capacitor.

This may also happen if the capacitor is overheated by an external heat source.

Shock and/or vibration load for larger case sizes

For increased shock and vibration applications involving larger case sizes (i.e., PCM 22.5 mm pin spacing or greater), it is recommended to fix capacitors in an appropriate way; or special pin and plate terminations may be required respectively to minimize lead separation from the capacitor element or the solder joint.

Processing

When processing plastic film capacitors it is mandatory to observe the application recommendations with regard to soldering and/or cleaning and drying processes.

General remarks

All catalogue data, range surveys and application data correspond to the actual state of the art and were elaborated as thoroughly and precisely as possible. They are to be understood as general information, and the right for amendments and construction changes is reserved. Special customized designs which deviate from our catalogue data, irrespective of whether being based on factory standards, specifications or related data, do not release the user from his duty of care with regard to incoming goods inspection and production monitoring. In case of the components being purchased through second or third suppliers we urgently ask to compare the technical details with the data given by the manufacturer. In cases of doubt we recommend use is made of our technical support, since we do not take any responsibility for damages caused by inappropriate use or processing of our capacitors.

Construction Principles of WIMA Capacitors

Film and Foil Construction

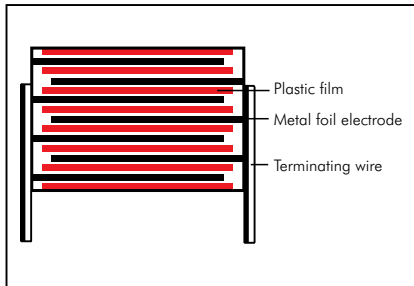

WIMA Types:

FKP 02	FKS 2	FKP 2
FKP 3	FKP 3	

Metallized Construction

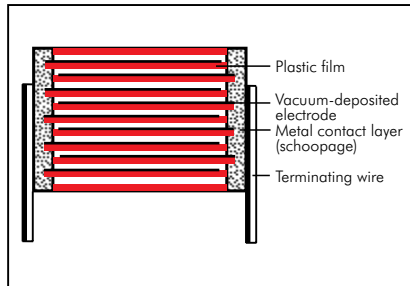

WIMA Types:

SMD-PET	SMD-PEN	SMD-PPS
MKS 4	MKP 4C	MKP 4
MP 3-Y2	DC-LINK MKP 3	DC-LINK MKP 4
DC-LINK HC	DC-LINK HY	

Advantages of Film/Foil Construction:

- High pulse and current rating
- High insulation resistance
- Close tolerances up to $\pm 1\%$

Disadvantages: short circuit at end of life

Advantages of Metallized Construction:

- High capacitances in small box sizes
- Excellent self-healing ability
- Very good price/performance ratio

Disadvantage: low pulse resistance

Film and Foil Construction with Internal Series Connection and Self-Healing, Metallized Plastic Film

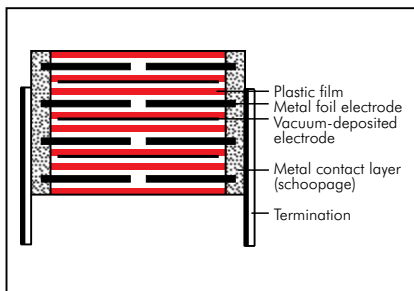

WIMA Types:

Snubber FKP

Film and Foil Construction with Internal Series Connection and Self-Healing Plastic Film Metallized on Both Sides

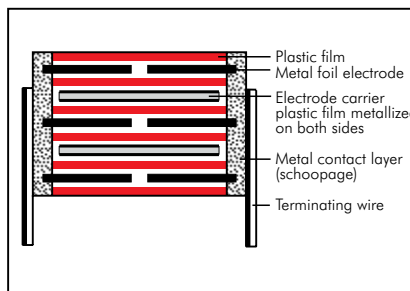

WIMA Types:

FKP 1

Pulse Duty Construction with Self-Healing Plastic Film Metallized on Both Sides

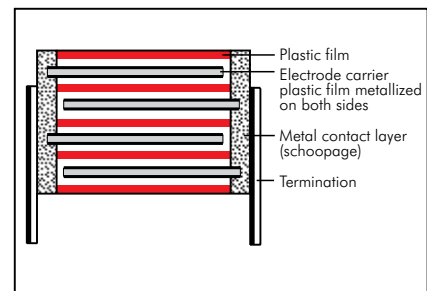

WIMA Types:

MKP 10*	GTO MKP*
---------	----------

*up to 250 VAC *up to 250 VAC

Pulse Duty Construction with Internal Series Connection and Self-Healing Plastic Film Metallized on Both Sides

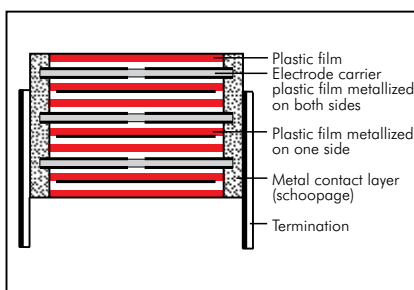

WIMA Types:

MKP 10*	Snubber MKP	GTO MKP*
---------	-------------	----------

*400 to 700 VAC

*from 400 VAC

Metallized Construction with Internal Series Connection

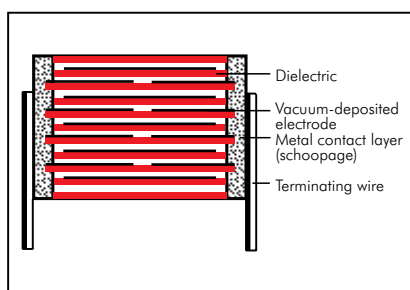

WIMA Types:

MKS 4*	MKP 4*	MKP 4F
--------	--------	--------

*400 VAC *400 VAC

MKP-X1 R	MKP-Y2	MP 3R-Y2
----------	--------	----------

Typical Characteristics and Graphs of the Polyester (PET) Film

Polyester Film and Foil Types

FKS 2

FKS 3

Metallized Polyester Types

SMD-PET

MKS 02

MKS 2

MKS 4

Typical Applications

For general DC-applications e.g.

- By-pass
- Blocking
- Coupling and decoupling
- Timing

Film Properties

Dielectric constant

at 1 kHz and +23° C:

3.3 positive as temperature rise

Specific volume resistance

in Ω cm at +23° C:

10^{18}

Dielectric strength (DC voltage)

in V/ μ m at +23° C:

580

Preferred temperature range

in ° C:

-55 to +100

Dielectric absorption

in % at + 23° C:

0.20 to 0.25

Typical Graphs

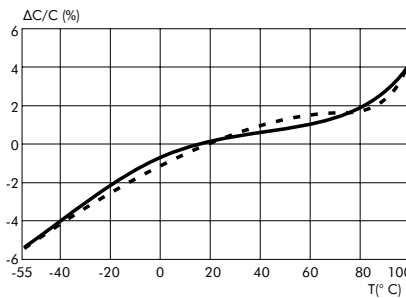

Capacitance change versus temperature (f=1 kHz) (general guide)

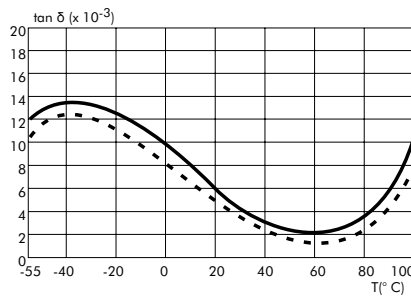

Dissipation factor change versus temperature (f=1 kHz) (general guide)

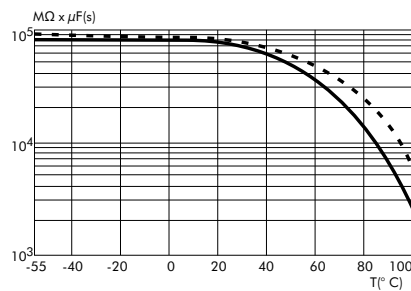

Insulation resistance change versus temperature (general guide)

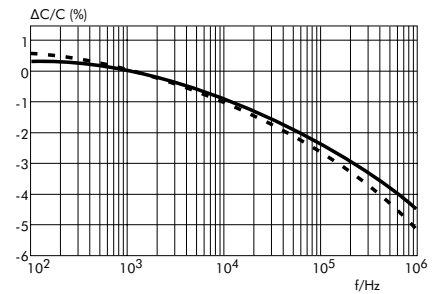

Capacitance change versus frequency (general guide)

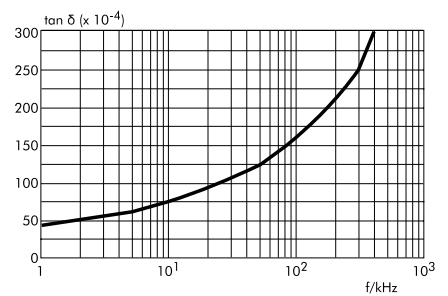

Dissipation factor change versus frequency. Example: MKS 4, 0.1 $\mu F/400VDC$ (general guide)

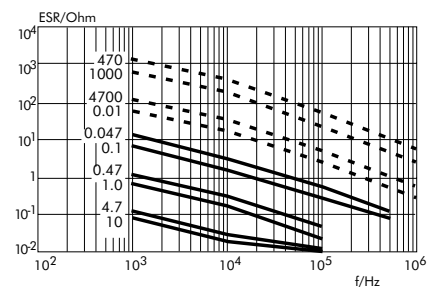

ESR change versus frequency (general guide)

The broken lines show the film and foil types.

The full lines characterize the metallized versions.



Typical Characteristics and Graphs of the Polypropylene (PP) Film

Polypropylene Film and Foil Types

FKP 02	FKP 2	FKP 3	FKP 1	Snubber FKP
--------	-------	-------	-------	-------------

Metallized Polypropylene Types

MKP 2	MKP 4C	MKP 4	MKP 10	MKP-X2	MKP-X1 R
MKP-Y2	MKP 4F	Snubber MKP	GTO MKP	DC-LINK MKP 3	DC-LINK MKP 4
DC-LINK MKP 4S	DC-LINK MKP 5	DC-LINK MKP 6	DC-LINK HC	DC-LINK HY	

Typical Applications

For high frequency and high pulse applications e.g.

- Sample and hold
- Timing
- LC-Filtering
- Oscillating circuits
- Audio equipment
- High frequency coupling and decoupling
- TV and monitor sets
- Lighting
- Power electronics

Film Properties

Dielectric constant

at 1 kHz and +23° C:
2.2 negative as temperature rise

Specific volume resistance

in Ω cm at +23° C:
 6×10^{18}

Dielectric strength (DC voltage)

in V/ μ m at +23° C:
650

Preferred temperature range

in ° C:
-55 to +100

Dielectric absorption

in % at + 23° C:
0.05 to 0.10

Typical Graphs

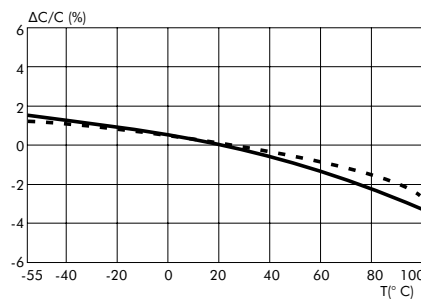

Capacitance change versus temperature (f=1 kHz) (general guide)

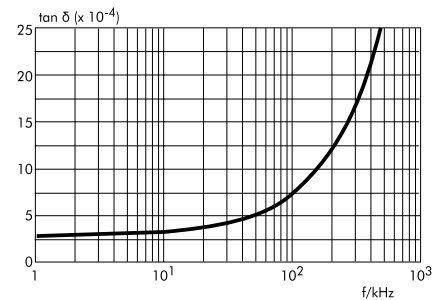

Dissipation factor change versus frequency. Example: MKP 10, 0.01 μ F/400VDC (general guide)

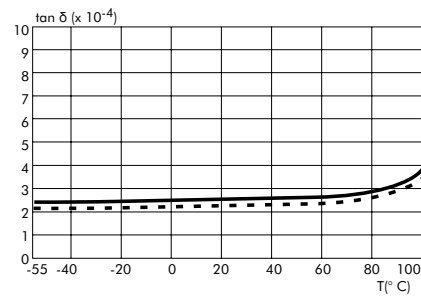

Dissipation factor change versus temperature (f=1 kHz) (general guide)

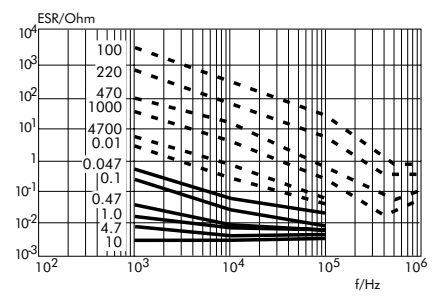

ESR change versus frequency (general guide)

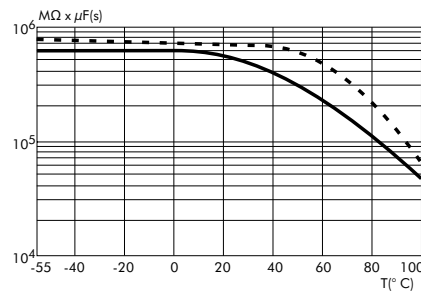

Insulation resistance change versus temperature (general guide)

The broken lines show the film and foil types.

The full lines characterize the metallized versions.

Typical Characteristics and Graphs of the Polyethylene-Naphthalate (PEN) Film

Metallized Polyethylene-Naphthalate Type

SMD-PEN

Typical Applications

For general DC-applications e.g.

- By-pass
- Blocking
- Coupling and decoupling
- Timing

Film Properties

Dielectric constant

at 1 kHz and +23° C:

3.0 positive as temperature rise

Specific volume resistance

in Ω cm at +23° C:

10^{18}

Dielectric strength (DC voltage)

in V/ μ m at +23° C:

580

Preferred temperature range

in ° C:

-55 to +125

Dielectric absorption

in % at + 23° C:

1.0

Typical Graphs

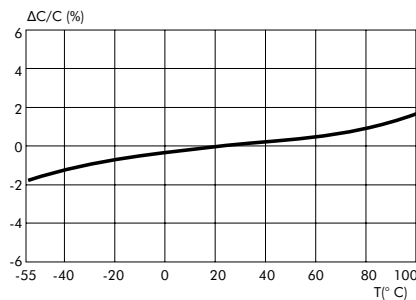

Capacitance change versus temperature (f=1 kHz) (general guide)

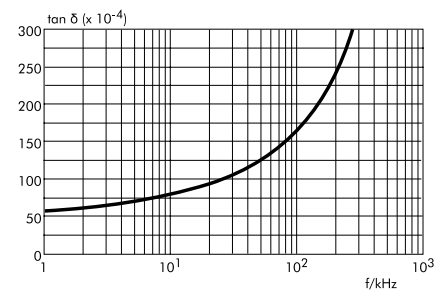

Dissipation factor change versus frequency. Example: SMD-PEN, 0.1 μ F/250 VDC (general guide)

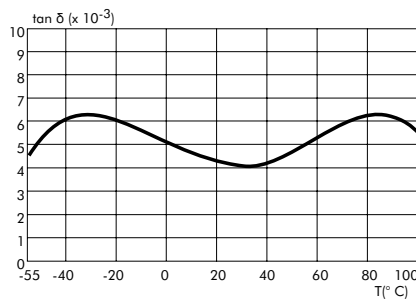

Dissipation factor change versus temperature (f=1 kHz) (general guide)

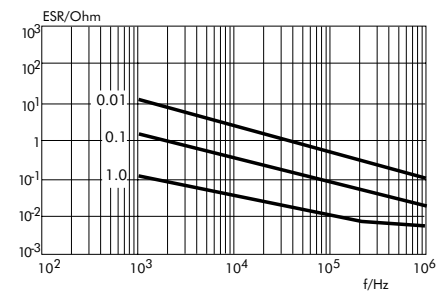

ESR change versus frequency (general guide)

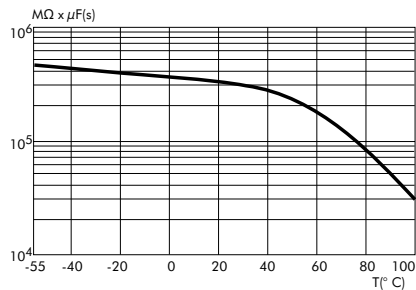

Insulation resistance change versus temperature (general guide)

Typical Characteristics and Graphs of the Polyphenylene-Sulphide (PPS) Film

Metallized Polyphenylene-Sulphide Type

SMD-PPS

Typical Applications

For general applications in high frequency and high temperature circuits e.g.

- By-pass
- Blocking
- Coupling and decoupling
- Timing
- Filtering
- Oscillating circuits
- TV and monitor sets
- Lighting
- Automotive electronics

Film Properties

Dielectric constant

at 1 kHz and +23° C:
3.0 very constant versus temperature

Specific volume resistance

in Ω cm at +23° C:
 5×10^{17}

Dielectric strength (DC voltage)

in V/ μ m at +23° C:
470

Preferred temperature range

in ° C:
-55 to +140

Dielectric absorption

in % at + 23° C:
0.05 to 0.10

Typical Graphs

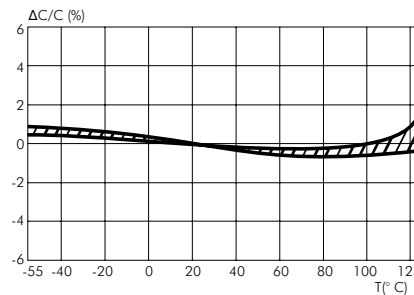

Capacitance change versus temperature (f=1 kHz) (general guide)

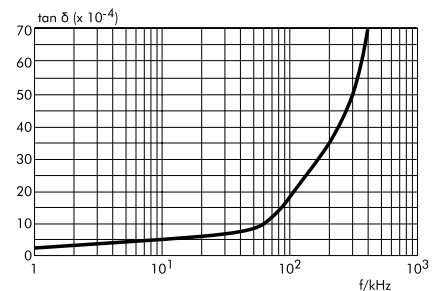

Dissipation factor change versus frequency. Example: SMD-PPS, 0.1 μ F/63 VDC (general guide)

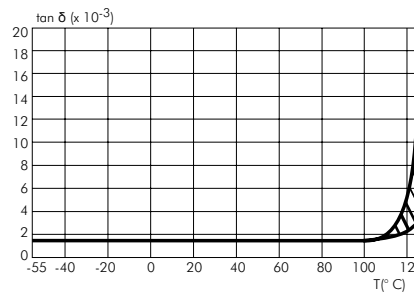

Dissipation factor change versus temperature (f=1 kHz) (general guide)

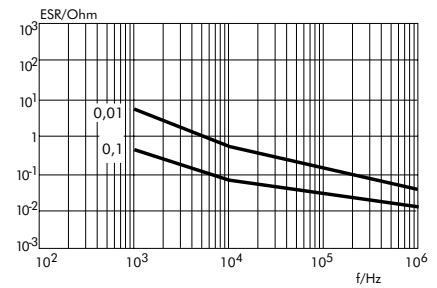

ESR change versus frequency (general guide)

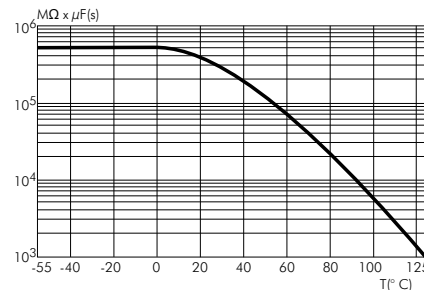

Insulation resistance change versus temperature (general guide)

Characteristics of Metallized Film Capacitors in Comparison with Other Dielectrics

	PET	PP	PEN	PPS	NPO	X7R	Tantalum
Dielectric constant 1 kHz/23° C	3.3 positive as temperature rise	2.2 negative as temperature rise	3.0 positive as temperature rise	3.0 very constant versus temperature	12 ... 40	700...2000	26
Operating temp. (° C)	-55...+100	-55...+100	-55...+125	-55...+140	-55...+125	-55...+125	-55...+125
Dielectric absorption (%)	0.2 ... 0.25	0.05 ... 0.10	1.0	0.05	0.6	2.5	n. a.
$\Delta C/C$ versus temperature (%)	± 5	± 2.5	± 5	± 1.5	± 0.3	± 15	± 10
$\Delta C/C$ versus voltage (%)	negligible	negligible	negligible	negligible	negligible	-20	negligible
ΔC aging rate (%/h decreasing)	negligible	negligible	negligible	negligible	negligible	2	n. a.
Dissipation factor (%) 1 kHz 10 kHz 100 kHz	0.8 1.5 3.0	0.05 0.08 0.25	0.8 1.5 3.0	0.2 0.25 0.5	0.10 0.10 0.10	2.5	8
ESR	low	very low	low	very low	low	moderate	high
Ris ($M\Omega \times \mu F$) 25° C 85° C	10 000 1 000	100 000 10 000	10 000 1 000	10 000 1 000	10 000 1 000	1 000 500	100 10
Capacitance range from pF to μF	1 000 ... 680	27 ... 400	10 000 ... 1.0	10 000 ... 2.2	1... 0.1	100 ... 2.2	100 000 ... 1 000
Capacitance tolerance ($\pm\%$)	5/10/20	1/2.5/5/10/20	5/10/20	2.5/5/10/20	5/10	10/20	10/20
Self-healing	yes	yes	yes	yes	no	no	no
Typical failure mode at end of life	open	open	open	open	short	short	short
Reliability	high	high	high	high	high	moderate	low
Piezoelectric effect	no	no	no	no	no	yes	yes
Resistance to thermal and mechanical shock	high	high	high	high	moderate to low	moderate to low	high
Polarity	no	no	no	no	no	no	yes

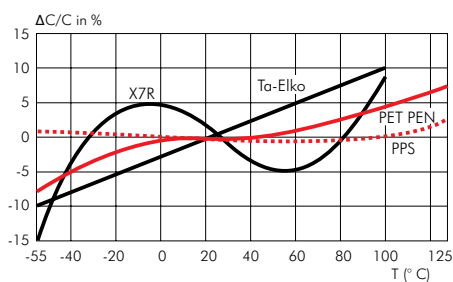

Capacitance change versus temperature (f=1 kHz) (general guide)

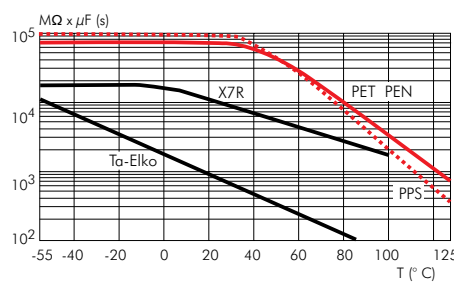

Insulation resistance change versus temperature (general guide)

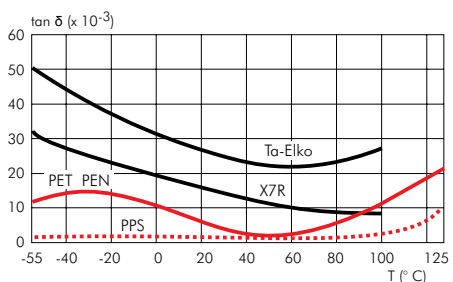

Dissipation factor change versus temperature (f=1 kHz) (general guide)

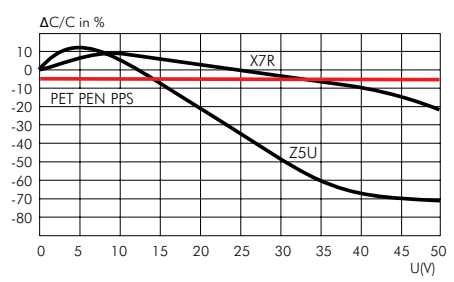

Capacitance change versus voltage (general guide)

Technical Data and Advantages of the Film Capacitors

Reliability

The failure rate in fit ($10^{-9}/h$) for plastic film capacitors is shown in the formula:

$$\lambda = \lambda_0 \times \pi_T \times \pi_V$$

λ_0 = expected value
 π_T = temperature factor
 π_V = voltage factor

The expected value has been determined for each component on the basis of life tests. If such a test is carried out at e.g. $T=85^\circ C$, this corresponds to an operating time of approx. 150.000 - 200.000 h in an equipment with $\leq 40^\circ C$ ambient temperature. Nowadays the best values are achieved by our metallized Polyester film capacitors with an expected value of 2 fit and a failure rate of $\lambda=10$ fit.

Self-Healing

The self-healing process in metallized plastic film capacitors is started by an electric breakdown, which takes about 10^{-8} sec. Temperatures of approximately 6000 K occur and evaporate the metallization around the failure spot. Insulated areas are formed and the capacitor continues to function properly.

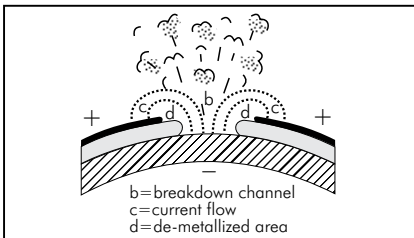

Inductance and Self-Resonance

Depending on the construction, an alternating current in the capacitor winding creates a more or less distinctive magnetic field which can be measured as inductance L. Nowadays, modern plastic film capacitors are contacted over the whole end surface of the winding element. In this way the self-inductance of the winding element is short-circuited and is reduced to the PCM (0.8 nH/mm) and the remaining length of the terminating wires (in case of SMD capacitors the distance between the soldering plates). L and C form a series oscillating circuit; at a frequency of

Old type with high self-inductance

The tape length of the winding element determines the value of the self-inductance

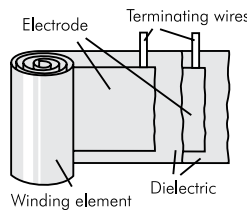

Modern WIMA type with low self-inductance

WIMA MKS 02/PCM 2.5 mm Self-inductance $L < 8$ nH
 WIMA SMD/Size Code 1812 Self-inductance $L < 6$ nH

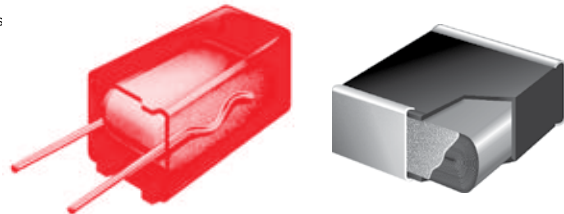

Average value for practical applications: inductance related to length = 0.8 nH/mm
 Example: length of the terminating wires = 2 x 3 mm + PCM.

$$f_0 = \frac{1}{2\pi \times \sqrt{L \times C}}$$

the capacitor is in self-resonance and has the lowest impedance, which only consists of r (ESR).

Dissipation Factor and ESR

The dissipation factor $\tan \delta$ is the quotient of the active and reactive components of the impedance. The losses occur mainly in the dielectric and are represented by R in the equivalent circuit diagram. Parallel to R is the insulation resistance R_{is} , which, in fact, only affects $\tan \delta$ at very low frequencies. Further dissipation is caused by the finite conductivity of the electrodes and the transfer resistance between the electrodes and the terminating wires. This is represented in the equivalent circuit diagram by the series resistance r. L represents the remaining self-inductance.

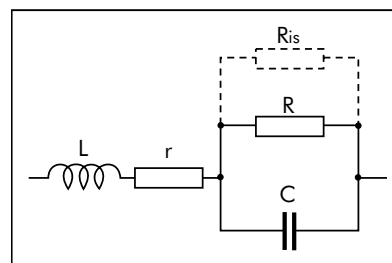

The dissipation factor is, for example, of importance for AC capacitors, which are subjected to strong currents: too high a $\tan \delta$ can lead to excessive heating brought about by the incoming active power and thus to a shorter life time of the capacitor.

Values of ESR are not directly stated in the data sheets of plastic film capacitors. The ESR for an individual capacitance value C can be calculated by the formula:

$$ESR = \tan \delta \times (2 \times \pi \times f \times C)^{-1}$$

$\tan \delta$: see data sheet of the respective WIMA type
 f: frequency of the AC voltage share in the application.
 ESR values for certain capacitances see characteristics of film dielectrics page 5.

Box Encapsulation

All WIMA series are produced with the proven box technology, showing the following advantages in comparison with non-encapsulated or dipped versions

- Safe protection of the capacitor element against mechanical stresses during processing and operation
- No danger of internal cracks, delamination or tearing away of the contacts due to construction elasticity
- Excellent self-healing properties of metallized capacitors due to pressure free layers in the winding element
- Solvent-resistant and flame-retardant plastic case in accordance with UL 94 V-0
- Clearly defined dimensions allows for close placement and exact setting of parts on PC-boards. Even larger parts are easily robotically insertable.

Stress Computation for WIMA Capacitors



The maximum permissible AC voltage that can be applied to capacitors in **sinusoidal** waveform applications, can be determined from the graphs in this catalogue.

However, where **pulse conditions** exist, the following procedure is to be observed to ensure that the correct capacitor rating is selected for a particular duty:

1. **Rated Voltage (U_r):** The rated voltage of a capacitor against a zero potential reference point shall take into consideration that the dielectric strength of the capacitor film diminishes with rising frequency. The calculation of the required rated voltage of a capacitor must therefore allow for the correction factor k; where k = dielectric strength of the film at the frequency f in % is shown in graph 1.

The calculation of the required dielectric strength is shown in the following example (U_{min}, U_{max} have the same polarity).

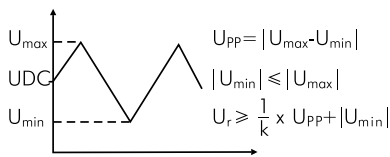

Furthermore the rms voltage derived from the peak to peak voltage shall not be greater than the nominal AC voltage rating of the capacitor to avoid the ionization inception level:
 $U_{rms} \leq U_{AC \text{ rated}}$

2. **Maximum current:** The voltage gradient or rise time of the pulse is taken as the reference point when calculating the maximum current rating of the end contacts. The maximum permissible current load on the end contacts is calculated by means of the voltage rise of the pulses (pulse rise time F).
 $I_{max} = F \times C \times 1.6$
 The data of the rated pulse rise time F_r for pulses equal to the rated voltage figure in the technical data of the different types.

With low voltage rise in operation (U_{pp}) the permissible current load is calculated as follows:

$$F_{max} = \frac{U_r}{U_{pp}} \times F_r$$

for example
 $U_r = 63 \text{ V}, U_{pp} = 12 \text{ V}, F_r = 50 \text{ V}/\mu\text{sec}$.

$$\text{hence } F_{max} = \frac{63}{12} \times 50 = 262.5 \text{ V}/\mu\text{sec}$$

When using maximum current ratings, self-heating must be taken into account at higher frequencies, and must not exceed 10 K.

3. **Dissipation (heat losses):** The heat dissipated by a capacitor when stressed by non-sinusoidal voltages or when under pulse conditions can be approximately determined from the following formula:

$$P_d = U_{rms}^2 \times \omega C \times \tan \delta \text{ where } P_d = \text{dissipation in Watts (see table 1 for the max. W per Kl)}$$

$$U_{rms} = \text{root mean square value of the AC voltage share.}$$

$$\omega = 2\pi \times f, \text{ where } f \text{ is the repetition frequency of the pulse waveform (C = capacitance in Farad)}$$

$$\tan \delta = \text{dissipation factor corresponding to the frequency of the steepest part of the pulse.}$$

$$\text{pulse frequency} = \frac{1}{\text{pulse width}}$$

$$\text{The temperature rise is as follows: Temperature rise in K} = \frac{\text{calculated dissipation}}{\text{specific dissipation}} \text{ (see table 1)}$$

In applications where reliability is critical, it is recommended to measure the surface temperature of the capacitor and to take into account that the temperature within the capacitor will be approximately 5 K above the case temperature.

4. **Determining the permissible AC voltage and AC current at given frequencies:**

To determine the permissible AC voltage (sinusoidal) for applications in a higher frequency spectrum, graphs showing AC voltage derating with frequency are available for the respective WIMA series. The diagrams refer to a permissible self-heating of:

$$\Delta \theta \leq 10 \text{ K}$$

For the WIMA MKP 10/0.01 μF/630 VDC/400 VAC, for example, this shows – when f = 50 kHz – a permissible AC voltage of

$$U_{rms} = 280 \text{ V (graph 2)}$$

The AC voltage given in the diagrams can also be used to determine the maximum effective current.

$$X_c = \frac{1}{\omega \times C} = \frac{1}{2\pi \times 50 \text{ kHz} \times 0.01 \mu\text{F}}$$

$$X_c = 318 \Omega$$

$$I_c = \frac{U_c}{X_c} = \frac{280 \text{ V}}{318 \Omega}$$

$$I_c = 0.88 \text{ A}$$

The calculated maximum value of the effective current

$$I_p = I_c \times \sqrt{2} = 0.88 \text{ A} \times \sqrt{2}$$

$$I_p = 1.24 \text{ A}$$

must not exceed the maximum current rating specified in the maximum pulse rise time calculation (cf. F_{max} on left). In this case, the operating AC voltage is to be reduced accordingly.

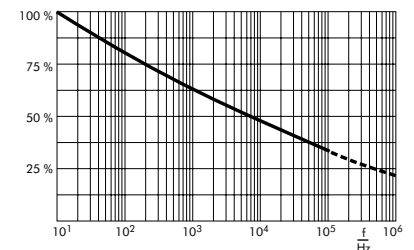

Graph 1: Dielectric strength of Polypropylene film as a factor of frequency (general guide).

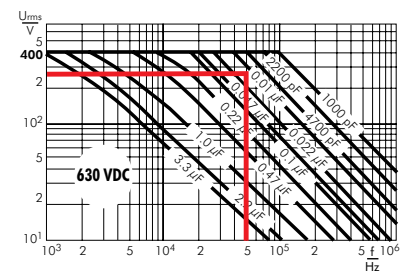

Graph 2: Permissible AC voltage in relation to frequency at 10°C internal temperature rise (general guide).

Printed circuit module PCM (in mm)	Specific dissipation in Watts per K above the ambient temperature
2.5	0.0025
5	0.004
7.5	0.006
10	0.0075
15	0.012
22.5	0.015
27.5	0.025
37.5	0.03

Table 1: The data is for ordinary assembly and ventilation conditions avoiding radiant heat within the chassis of the equipment

The Selection of Capacitors for Pulse Applications

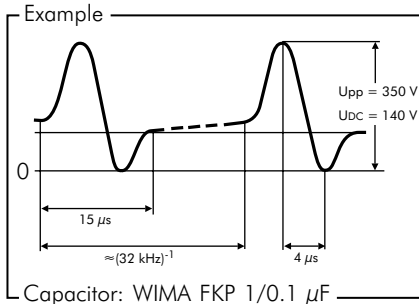

Value from table "pulse rise time WIMA FKP 1", page 70: 7000 V/μsec.

The calculated voltage gradient is lower than the permissible value shown in the catalogue for this capacitor.

Dissipation

Given: $U_{rms} = 85 \text{ V}$
 $f = 32 \text{ kHz}$
 $C = 0.1 \text{ μF}$

The frequency determined from the steepest part of the pulse is:
 Pulse width = 15 μsec. = 1 cycle

Hence pulse frequency = $\frac{1}{15 \times 10^{-6}} \approx 66 \text{ kHz}$

The $\tan \delta$ of WIMA FKP 1 at 66 kHz $\approx 10 \times 10^{-4}$ (graph 4).

$P_d = 85^2 \times 2 \pi \times 32 \times 10^3 \times 0.1 \times 10^{-6} \times 10 \times 10^{-4} \approx 0.145 \text{ Watts}$

The selected capacitor has a pin spacing of 27.5 mm (table 1, page 11 specific dissipation = 0.025 Watts/K) and the

temperature rise due to self-heating is:

Temperature rise = $\frac{0.145 \text{ Watts}}{0.025 \text{ Watts/K}} \approx + 6 \text{ K}$

The temperature rise plus the max. ambient temperature \leq max. permissible operating temperature (taking into account the voltage derating factor as detailed in the Technical Data). If the permissible temperature is exceeded, please select a capacitor with a higher voltage rating.

Determination of nominal voltage

Calculation is based on an operating temperature $< +60^\circ \text{ C}$ unless other data is given by the user.

$U_r \geq 350 \text{ V}$
 $U_{rms} = 85 \text{ V}$ (referring to AC voltage share)
 Selected nominal voltage:
 400 VDC/250 VAC pin spacing 27.5 mm

Permissible voltage gradient

The voltage rise time is:

$\frac{350 \text{ V}}{4 \text{ μsec.}} \approx 87.5 \text{ V/μsec}$

Optionally a recommendation can be offered by our engineers upon receipt of voltage and current oscillogrammes.

Questionnaire available on demand.

WIMA FKP 1 Pulse Capacitors for Very High Current Ratings

The WIMA FKP1 series was developed for extremely high pulse loads. It has an internal series connection, the metal foil electrodes being combined with a floating electrode metallized on both sides. The metal foil electrodes are safely contacted on both sides of the end surfaces and allow for high current and pulse loading capabilities. At the same time the capacitor is fully self-healing due to the floating electrode metallized on both sides.

As regards pulse loading capability, WIMA FKP 1 represent the high-end of capacitor technology.

More information see page 70.

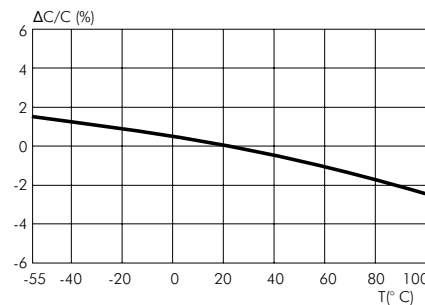

Capacitance change versus temperature (f=1 kHz) (general guide).

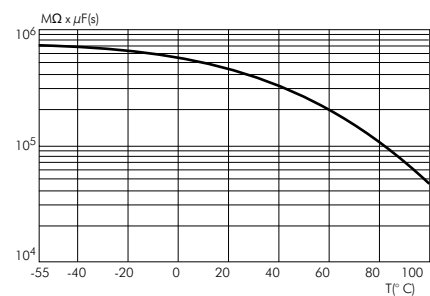

Insulation resistance change versus temperature (general guide).

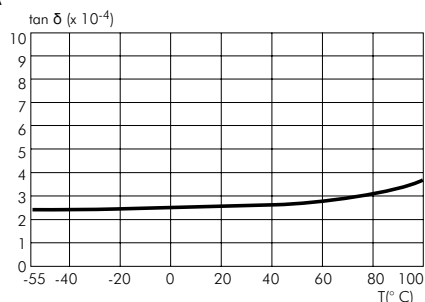

Dissipation factor change versus temperature (f=1 kHz) (general guide).

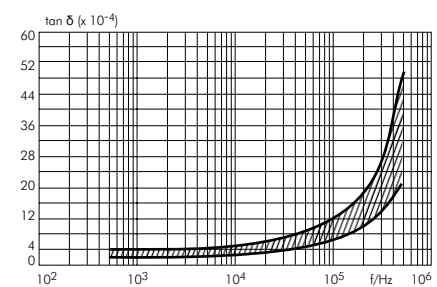

Dissipation factor change versus frequency (general guide).

Recommendation for Processing and Application of SMD Capacitors



Layout Form

The components can generally be positioned on the carrier material as desired. In order to prevent soldering shadows or ensure regular temperature distribution, extreme concentration of the components should be avoided. In practice, it has proven best to keep a minimum distance of the soldering surfaces between two WIMA SMDs of twice the height of the components.

Solder Pad Recommendation

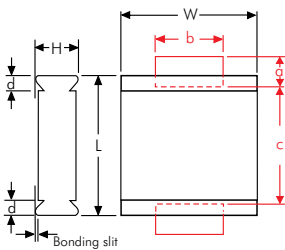

Size code	L ± 0.3	W ± 0.3	d	a min.	b min.	c max.
1812	4.8	3.3	0.5	1.2	3.5	3.5
2220	5.7	5.1	0.5	1.2	4	4.5
2824	7.2	6.1	0.5	1.2	4	6.5
4030	10.2	7.6	0.5	2.5	6	9
5040	12.7	10.2	0.7	2.5	6	11.5
6054	15.3	13.7	0.7	2.5	6	14

The solder pad size recommendations given for each individual series are to be understood as minimum dimensions which can at any time be adjusted to the layout form.

Processing

The processing of SMD components

- assembling
- soldering
- electrical final inspection/calibrating

must be regarded as a complete process. The soldering of the printed circuit board, for example, can constitute considerable stress on all the electronic components. The manufacturer's instructions on the processing of the components are mandatory.

Soldering Process

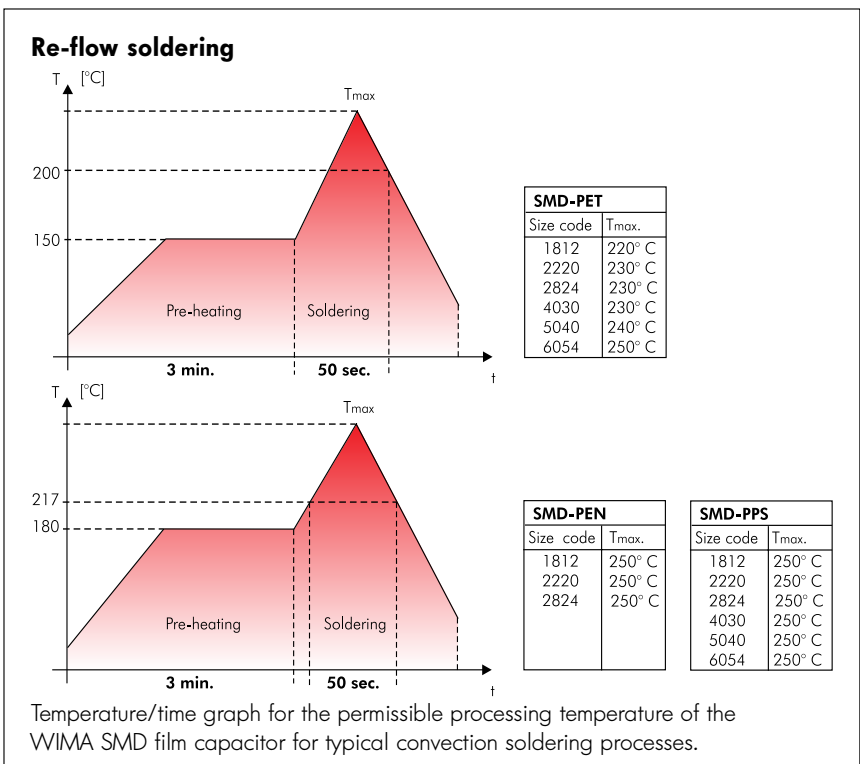

Due to versatile procedures exact processing parameters for re-flow soldering processes cannot be specified. The graph depicted is to be understood as a recommendation to help establishing a suitable soldering profile fulfilling the requirements

in practice at the user. During processing a max. temperature of T=210° C inside the component should not be exceeded. Due to the differing heat absorption the length of the soldering process should be kept as short as possible for smaller size codes.

SMD Handsoldering

WIMA SMD capacitors with plastic film dielectric are generally suitable for hand-soldering, e. g. for lab purposes, with a soldering iron where, however, similar to automated soldering processes, a certain duration and temperature should not be exceeded. These parameters are dependent on the physical size of the components and the relevant heat absorption involved.

The below data are to be regarded as guideline values and should serve to avoid damage to the dielectric caused by excessive heat during the soldering process. The soldering quality depends on the tool used and on the skill and experience of the person with the soldering iron in hand.

Size code	Temperature °C / °F	Time duration
1812	250 / 482	2 sec plate 1 / 5 sec off / 2 sec plate 2
2220	250 / 482	3 sec plate 1 / 5 sec off / 3 sec plate 2
2824	260 / 500	3 sec plate 1 / 5 sec off / 3 sec plate 2
4030	260 / 500	5 sec plate 1 / 5 sec off / 5 sec plate 2
5040	260 / 500	5 sec plate 1 / 5 sec off / 5 sec plate 2
6054	260 / 500	5 sec plate 1 / 5 sec off / 5 sec plate 2

Recommendation for Processing and Application of SMD Capacitors (Continuation)

Solder Paste

To achieve reliable soldering results one of the following solder alloys have from case to case proven being workable:

Lead free solder paste

Sn - Bi
Sn - Zn (Bi)
Sn - Ag - Cu (suitable for SMD-PET 5040/6054, SMD-PEN and SMD-PPS)

Solder paste with lead

Sn - Pb - Ag (Sn60-Pb40-A, Sn63-Pb37-A)

Washing

WIMA SMD components with plastic encapsulation - like all other components of similar construction irrespective of the make - cannot be regarded as hermetically sealed. Due to today's common washing substances, e. g. on aqueous basis instead of the formerly used halogenated hydrocarbons, with enhanced washing efficiency it became obvious that assembled SMD capacitors may show an impermissibly high deviation of the electrical parameters after a corresponding washing process. Hence it is recommended to refrain from applying industrial washing processes for WIMA SMD capacitors in order to avoid possible damages.

Initial Operation/Calibration

Due to the stress which the components are subjected to during processing, reversible parameter changes occur in almost all electronic components. The capacitance recovery accuracy to be expected with careful processing is within a scope of

$$|\Delta C/C| \leq 5 \%$$

For the initial operation of the device a minimum storage time of

$$t \geq 24 \text{ hours}$$

is to be taken into account. With calibrated devices or when the application is largely dependent on capacitance it is

advisable to prolong the storage time to

$$t \geq 10 \text{ days}$$

In this way ageing effects of the capacitor structure can be anticipated. Parameter changes due to processing are not to be expected after this period of time

Humidity Protection Bags

Taped WIMA SMD capacitors are shipped in humidity protection bags according to JEDEC standard (ESD/EMI-shield/water-vapour proof).

Under controlled conditions the components can be stored two years and more in the originally sealed bag. Opened packing units should immediately be used up for processing. If storage is necessary the opened packing units should be stored air-tight in the original plastic bag.

Reliability

Taking account of the manufacturer's guidelines and compatible processing, the WIMA SMD stand out for the same high quality and reliability as the analogous through-hole WIMA series. The technology of metallized film capacitors used e.g. in WIMA SMD-PET achieves the best values for all fields of application. The expected value is about:

$$\lambda_0 \leq 2 \text{ fit}$$

Furthermore the production of all WIMA components is subject to the regulations laid down by ISO 9001:2008 as well as the guidelines for component specifications set out by IEC quality assessment system (IECQ) for electronic components.

Electrical Characteristics and Fields of Application

Basically the WIMA SMD series have the same electrical characteristics as the analogous through-hole WIMA capacitors. Compared to ceramic or tantalum dielectrics WIMA SMD capacitors have a

number of other outstanding qualities:

- favourable pulse rise time
- low ESR
- low dielectric absorption
- available in high voltage series
- large capacitance spectrum
- stand up to high mechanical stress
- good long-term stability

As regards technical performance as well as quality and reliability, the WIMA SMD series offer the possibility to cover nearly all applications of conventionally through-hole film capacitors with SMD components. Furthermore, the WIMA SMD series can now be used for all the demanding capacitor applications for which, in the past, the use of through-hole components was mandatory:

- measuring techniques
- oscillator circuits
- differentiating and integrating circuits
- A/D or D/A transformers
- sample and hold circuits
- automotive electronics

With the WIMA SMD programme available today, the major part of all plastic film capacitors can be replaced by WIMA SMD components. The field of application ranges from standard coupling capacitors to use in switch-mode power supplies as filter or charging capacitors with high voltage and capacitance values, as well as in telecommunications e.g. the well-known telephone capacitor $1 \mu\text{F}/250\text{VDC}$.

Recommendation for Processing and Application of Through-Hole Capacitors

Soldering Process

Internal temperature of the capacitor must be kept as follows:

Polyester: preheating: $T_{max.} \leq 125^{\circ}C$
soldering: $T_{max.} \leq 135^{\circ}C$

Polypropylene: preheating: $T_{max.} \leq 100^{\circ}C$
soldering: $T_{max.} \leq 110^{\circ}C$

Single wave soldering

Soldering bath temperature: $T < 260^{\circ}C$
Dwell time: $t < 5 \text{ sec}$

Double wave soldering

Soldering bath temperature: $T < 260^{\circ}C$
Dwell time: $\Sigma t < 5 \text{ sec}$

Due to different soldering processes and heat requirements the graphs are to be regarded as a recommendation only.

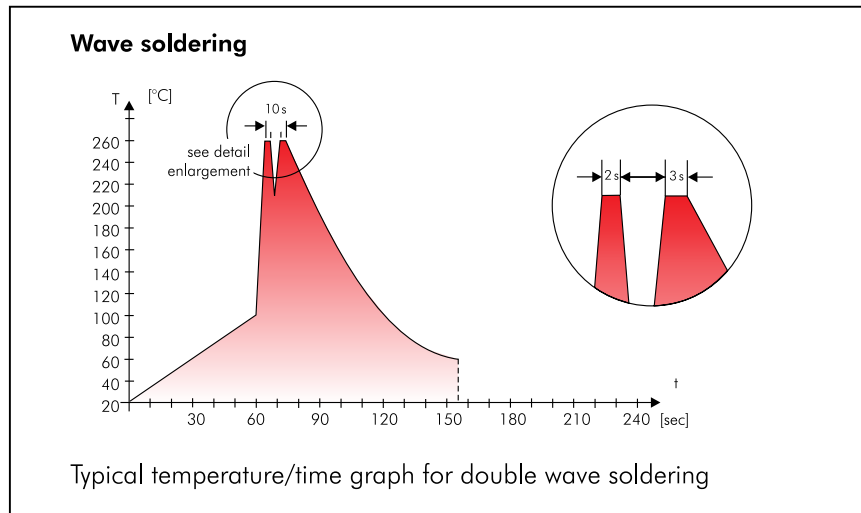

WIMA Quality and Environmental Philosophy

ISO 9001:2008 Certification

ISO 9001:2008 is an international basic standard of quality assurance systems for all branches of industry. The approval according to ISO 9001:2008 of our factories by the infaz (Institut für Auditierung und Zertifizierung) certifies that organisation, equipment and monitoring of quality assurance in our factories correspond to internationally recognized standards.

WIMA WPCS

The WIMA Process Control System (WPCS) is a quality surveillance and optimization system developed by WIMA. WPCS is a major part of the quality-oriented WIMA production. Points of application during production process:

- incoming material inspection
- metallization
- film inspection
- schoopage
- pre-healing
- pin attachment
- cast resin preparation/encapsulation
- 100% final inspection
- Testing as per customer requirements

WIMA Environmental Policy

All WIMA capacitors, irrespective of whether through-hole devices or SMD, are made of environmentally friendly materials. Neither during manufacture nor in the product itself any toxic substances are used, e.g.

- Lead
- PCB
- CFC
- Hydrocarbon chloride
- Chromium 6+
- PBB/PBDE
- Arsenic
- Cadmium
- Mercury
- etc.

We merely use pure, recyclable materials for packing our components, such as:

- carton
- cardboard
- adhesive tape made of paper
- polystyrene

We almost completely refrain from using packing materials such as:

- foamed polystyrene (Styropor®)
- adhesive tapes made of plastic
- metal clips

RoHS Compliance

According to the RoHS Directive 2011/65/EU certain hazardous substances like e.g. lead, cadmium, mercury must not be used any longer in electronic equipment as of July 1st, 2006. For the sake of the environment WIMA has refrained from using such substances since years already.



WIMA Kondensatoren sind bleifrei konform RoHS 2011/65/EU

WIMA capacitors are lead free in accordance with RoHS 2011/65/EU

Tape for lead-free WIMA capacitors

DIN EN ISO 14001:2004

WIMA's environmental management has been established in accordance with the guidelines of DIN EN ISO 14001:2004 to optimize the production processes with regard to energy and resources.

WIMA SMD Capacitors in Accordance with RoHS 2011/65/EU

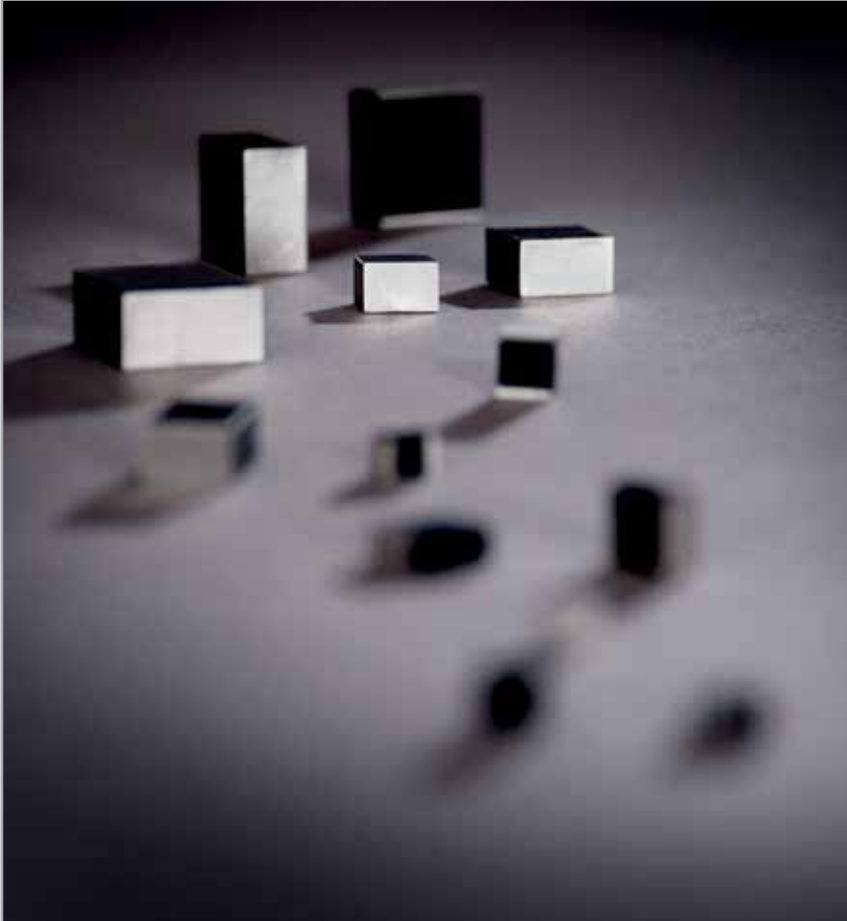

WIMA SMD-PET

WIMA SMD-PEN

WIMA SMD-PPS

WIMA SMD capacitors in size codes 1812, 2220, 2824, 4030, 5040 and 6054, capacitance values from 0.01 μF through 6.8 μF and voltage ranges of 63 VDC, 100 VDC, 250 VDC, 400 VDC, 630 VDC and 1000 VDC cover nearly the entire application range of conventional through-hole plastic film capacitors.

The WIMA SMD-PET is designed for general DC-applications e.g. coupling and decoupling, blocking, by-passing or timing and corresponds to the RoHS 2011/65/EU guidelines (Restriction of Hazardous Substances) of the EU.

The WIMA SMD-PEN is applicable for operating temperatures up to +125° C and thus suitable for lead-free solder pro-

cesses in accordance with RoHS.

The WIMA SMD-PPS has an operating temperature range up to +140° C and stands out for its stable capacitance and frequency behaviour versus temperature. Capacitors of this range are environmentally compatible with the RoHS 2011/65/EU guidelines.

All WIMA SMD series are produced with the proven box technology, showing the following advantages in comparison with non-encapsulated or moulded SMD capacitor versions:

- Safe protection of the capacitor element against mechanical and thermal stresses during processing and operation. When using more temperature resistant dielectrics like PEN or PPS an even larger safety margin than with non-encapsulated parts is obtained.
- No danger of internal cracks or tearing away of the contacts due to construction elasticity.
- No danger of delamination due to solder plates covering the capacitor's entire end surfaces.
- Solvent-resistant, flame-retardant plastic case in accordance with UL 94 V-0.

These features and the wide capacitance range enable WIMA SMDs to substitute other capacitor technologies and become standard components in electronic developments.

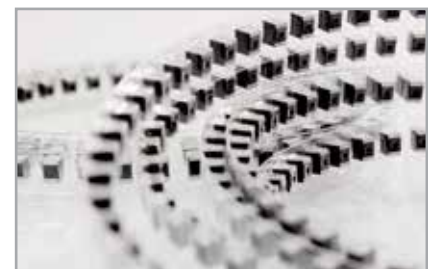

Metallized Polyester (PET) SMD Film Capacitors with Box Encapsulation. Capacitances from 0.01 μF to 6.8 μF . Rated Voltages from 63 VDC to 1000 VDC. Size Codes from 1812 to 6054.

Special Features

- Size codes 1812, 2220, 2824, 4030, 5040 and 6054 with PET and encapsulated
- Operating temperature up to 100° C
- Self-healing
- According to RoHS 2011/65/EU

Typical Applications

For general DC-applications e.g.

- By-pass
- Blocking
- Coupling and decoupling
- Timing

Construction

Dielectric:

Polyethylene-terephthalate (PET) film

Capacitor electrodes:

Vacuum-deposited

Internal construction:

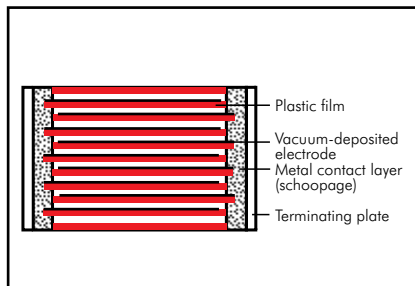

Encapsulation:

Solvent-resistant, flame-retardant plastic case, UL 94 V-0

Terminations:

Tinned plates.

Marking:

Box colour: Black.

Electrical Data

Capacitance range:

0.01 μF to 6.8 μF

Rated voltages:

63 VDC, 100 VDC, 250 VDC, 400 VDC, 630 VDC, 1000 VDC

Capacitance tolerances:

$\pm 20\%$, $\pm 10\%$ ($\pm 5\%$ available subject to special enquiry)

Operating temperature range:

-55°C to $+100^\circ\text{C}$ ($+125^\circ\text{C}$ available subject to special enquiry)

Climatic test category:

55/100/21 according to IEC

for size codes 1812 to 2824

55/100/56 according to IEC

for size codes 4030 to 6054

Insulation resistance at $+20^\circ\text{C}$:

U_r	U_{test}	$C \leq 0.33 \mu\text{F}$	$0.33 \mu\text{F} < C \leq 6.8 \mu\text{F}$
63 VDC	50 V	$\geq 3.75 \times 10^3 \text{ M}\Omega$	$\geq 1250 \text{ sec} (\text{M}\Omega \times \mu\text{F})$
100 VDC	100 V	(mean value: $1 \times 10^4 \text{ M}\Omega$)	(mean value: 3000 sec)
$\geq 250 \text{ VDC}$	100 V	$\geq 1 \times 10^4 \text{ M}\Omega$	$\geq 3000 \text{ sec} (\text{M}\Omega \times \mu\text{F})$
		(mean value: $5 \times 10^4 \text{ M}\Omega$)	(mean value: 10000 sec)

Measuring time: 1 min.

Dissipation factors at $+20^\circ\text{C}$: $\tan \delta$

at f	$C \leq 0.1 \mu\text{F}$	$0.1 \mu\text{F} < C \leq 1.0 \mu\text{F}$	$C > 1.0 \mu\text{F}$
1 kHz	$\leq 8 \times 10^{-3}$	$\leq 8 \times 10^{-3}$	$\leq 10 \times 10^{-3}$
10 kHz	$\leq 15 \times 10^{-3}$	$\leq 15 \times 10^{-3}$	–
100 kHz	$\leq 30 \times 10^{-3}$	–	–

Maximum pulse rise time: for pulses equal to the rated voltage

Capacitance μF	Pulse rise time V/ μsec max. operation/test					
	63 VDC	100 VDC	250 VDC	400 VDC	630 VDC	1000 VDC
0.01 ... 0.022	30/300	35/350	40/400	35/350	40/400	50/500
0.033 ... 0.068	20/200	20/200	40/400	21/210	25/250	32/320
0.1 ... 0.22	10/100	10/100	12/120	14/140	17/170	–
0.33 ... 0.68	8/80	6/60	9/90	10/100	–	–
1.0 ... 2.2	3.5/35	4/40	7/70	–	–	–
3.3 ... 6.8	3/30	3/30	–	–	–	–

Dip Solder Test/Processing

Resistance to soldering heat:

Test Tb in accordance with DIN IEC

60068-2-58/DIN EN 60384-19.

Soldering bath temperature max. 260°C .

Soldering duration max. 5 sec.

Change in capacitance $\Delta C/C < 5\%$.

Soldering process:

Re-flow soldering (see temperature/time graphs page 131).

Packing

Available taped and reeled in blister pack.

Detailed taping information and graphs at the end of the catalogue.

For further details and graphs please refer to Technical Information.

Continuation

General Data

Capacitance	63 VDC/40 VAC*			100 VDC/63 VAC*			250 VDC/160 VAC*					
	Size code	H ± 0.3	Part number	Size code	H ± 0.3	Part number	Size code	H ± 0.3	Part number			
0.01 µF	1812	3.0	SMDTC02100KA00	1812	3.0	SMDTD02100KA00	2220	3.5	SMDTF02100QA00			
	2220	3.5	SMDTC02100QA00	2220	3.5	SMDTD02100QA00	2824	3.0	SMDTF02100TA00			
	2824	3.0	SMDTC02100TA00	2824	3.0	SMDTD02100TA00						
0.015 "	1812	3.0	SMDTC02150KA00	1812	3.0	SMDTD02150KA00	2220	3.5	SMDTF02150QA00			
	2220	3.5	SMDTC02150QA00	2220	3.5	SMDTD02150QA00	2824	3.0	SMDTF02150TA00			
	2824	3.0	SMDTC02150TA00	2824	3.0	SMDTD02150TA00						
0.022 "	1812	3.0	SMDTC02220KA00	1812	3.0	SMDTD02220KA00	2220	3.5	SMDTF02220QA00			
	2220	3.5	SMDTC02220QA00	2220	3.5	SMDTD02220QA00	2824	3.0	SMDTF02220TA00			
	2824	3.0	SMDTC02220TA00	2824	3.0	SMDTD02220TA00						
0.033 "	1812	3.0	SMDTC02330KA00	1812	3.0	SMDTD02330KA00	2220	3.5	SMDTF02330QA00			
	2220	3.5	SMDTC02330QA00	2220	3.5	SMDTD02330QA00	2824	3.0	SMDTF02330TA00			
	2824	3.0	SMDTC02330TA00	2824	3.0	SMDTD02330TA00	4030	5.0	SMDTF02330VA00			
0.047 "	1812	3.0	SMDTC02470KA00	1812	3.0	SMDTD02470KA00	2220	3.5	SMDTF02470QA00			
	2220	3.5	SMDTC02470QA00	2220	3.5	SMDTD02470QA00	2824	3.0	SMDTF02470TA00			
	2824	3.0	SMDTC02470TA00	2824	3.0	SMDTD02470TA00	4030	5.0	SMDTF02470VA00			
0.068 "	1812	3.0	SMDTC02680KA00	1812	3.0	SMDTD02680KA00	2220	4.5*	SMDTF02680QB00			
	2220	3.5	SMDTC02680QA00	2220	3.5	SMDTD02680QA00	2824	3.0	SMDTF02680TA00			
	2824	3.0	SMDTC02680TA00	2824	3.0	SMDTD02680TA00	4030	5.0	SMDTF02680VA00			
0.1 µF	1812	4.0*	SMDTC03100KB00	1812	4.0*	SMDTD03100KB00	2220	4.5*	SMDTF03100QB00			
	2220	3.5	SMDTC03100QA00	2220	3.5	SMDTD03100QA00	2824	5.0	SMDTF03100TB00			
	2824	3.0	SMDTC03100TA00	2824	3.0	SMDTD03100TA00	4030	5.0	SMDTF03100VA00			
0.15 "	1812	4.0*	SMDTC03150KB00	1812	4.0	SMDTD03150KB00	2824	5.0	SMDTF03150TB00			
	2220	3.5	SMDTC03150QA00	2220	3.5	SMDTD03150QA00	4030	5.0	SMDTF03150VA00			
	2824	3.0	SMDTC03150TA00	2824	3.0	SMDTD03150TA00						
0.22 "	1812	4.0*	SMDTC03220KB00	1812	4.0	SMDTD03220KB00	2824	5.0	SMDTF03220TB00			
	2220	3.5	SMDTC03220QA00	2220	3.5	SMDTD03220QA00	4030	5.0	SMDTF03220VA00			
	2824	3.0	SMDTC03220TA00	2824	3.0	SMDTD03220TA00						
0.33 "	1812	4.0	SMDTC03330KB00	2220	4.5	SMDTD03330QB00	2824	5.0	SMDTF03330TB00			
	2220	4.5*	SMDTC03330QB00	2824	5.0	SMDTD03330TB00	4030	5.0	SMDTF03330VA00			
	2824	5.0*	SMDTC03330TB00	4030	5.0	SMDTD03330VA00	5040	6.0	SMDTF03330XA00			
0.47 "	1812	4.0	SMDTC03470KB00	2220	4.5	SMDTD03470QB00	4030	5.0	SMDTF03470VA00			
	2220	4.5*	SMDTC03470QB00	2824	5.0	SMDTD03470TB00	5040	6.0	SMDTF03470XA00			
	2824	5.0*	SMDTC03470TB00	4030	5.0	SMDTD03470VA00						
0.68 "	2220	4.5	SMDTC03680QB00	2824	5.0	SMDTD03680TB00	5040	6.0	SMDTF03680XA00			
	2824	5.0*	SMDTC03680TB00	4030	5.0	SMDTD03680VA00						
	4030	5.0	SMDTC03680VA00	5040	6.0	SMDTD03680XA00						
1.0 µF	2220	4.5	SMDTC04100QB00	2824	5.0	SMDTD04100TB00	6054	7.0	SMDTF04100YA00			
	2824	5.0*	SMDTC04100TB00	4030	5.0	SMDTD04100VA00						
	4030	5.0	SMDTC04100VA00	5040	6.0	SMDTD04100XA00						
1.5 "	2824	5.0	SMDTC04150TB00	4030	5.0	SMDTD04150VA00	* Version according to catalogue 2013 still available <div style="border: 1px solid black; padding: 5px; width: fit-content;"> Part number completion: Tolerance: 20 % = M 10 % = K 5 % = J Packing: bulk = S Pin length: none = 00 Taped version see page 144. </div>					
	4030	5.0	SMDTC04150VA00	5040	6.0	SMDTD04150XA00						
2.2 "	2824	5.0	SMDTC04220TB00	5040	6.0	SMDTD04220XA00						
	4030	5.0	SMDTC04220VA00									
3.3 "	4030	5.0	SMDTC04330VA00	5040	6.0	SMDTD04330XA00						
4.7 "	5040	6.0	SMDTC04470XA00	6054	7.0	SMDTD04470YA00						
6.8 "	6054	7.0	SMDTC04680YA00									

* AC voltage: $f = 50 \text{ Hz}$; $1.4 \times U_{\text{rms}} + U_{\text{DC}} \leq U_r$

Dims. in mm.

Rights reserved to amend design data without prior notification.

Continuation

General Data

Capacitance	400 VDC/200 VAC*			630 VDC/300 VAC*			1000 VDC/400 VAC*		
	Size code	H ± 0.3	Part number	Size code	H ± 0.3	Part number	Size code	H ± 0.3	Part number
0.01 μ F	2824 4030	3.0 5.0	SMDTG02100TA00_____ SMDTG02100VA00_____ SMDTG02150TA00_____ SMDTG02150VA00_____	4030	5.0	SMDTJ02100VA00_____ SMDTJ02150VA00_____ SMDTJ02220XA00_____ SMDTJ02330XA00_____ SMDTJ02470XA00_____ SMDTJ02680XA00_____			
0.015 "	2824 4030	3.0 5.0		4030	5.0		5040	6.0	SMDTO12150XA00_____ SMDTO12220XA00_____ SMDTO12330XA00_____ SMDTO12470YA00_____
0.022 "	2824 4030	5.0* 5.0		5040	6.0		5040	6.0	
0.033 "	2824 4030	5.0 5.0		5040	6.0		5040	6.0	
0.047 "	2824 4030	5.0 5.0		5040	6.0		6054	7.0	
0.068 "	4030 5040	5.0 6.0		5040	6.0				
0.1 μ F	4030 5040	5.0 6.0	SMDTG03100VA00_____ SMDTG03100XA00_____ SMDTG03150VA00_____ SMDTG03150XA00_____ SMDTG03220XA00_____ SMDTG03330XA00_____ SMDTG03470YA00_____	6054	7.0	SMDTJ03100YA00_____ SMDTJ03150YA00_____ SMDTJ03220YA00_____ SMDTJ03330YA00_____			
0.15 "	4030 5040	5.0 6.0		6054	7.0				
0.22 "	5040	6.0		6054	7.0				
0.33 "	5040	6.0							
0.47 "	6054	7.0							

* AC voltage: $f = 50 \text{ Hz}$; $1.4 \times U_{\text{rms}} + U_{\text{DC}} \leq U_r$

* Version according to catalogue 2013 still available

Dims. in mm.

Solder pad recommendation

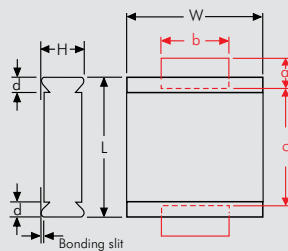

Part number completion:	
Tolerance:	20 % = M
	10 % = K
	5 % = J
Packing:	bulk = S
Pin length:	none = 00
Taped version see page 144.	

Size code	L ±0.3	W ±0.3	d	a min.	b min.	c max.
1812	4.8	3.3	0.5	1.2	3.5	3.5
2220	5.7	5.1	0.5	1.2	4	4.5
2824	7.2	6.1	0.5	1.2	4	6.5
4030	10.2	7.6	0.5	2.5	6	9
5040	12.7	10.2	0.7	2.5	6	11.5
6054	15.3	13.7	0.7	2.5	6	14

Rights reserved to amend design data without prior notification.

Metallized Polyethylene-Naphthalate (PEN) SMD Film Capacitors with Box Encapsulation. Capacitances from 0.01 μF to 1.0 μF . Rated Voltages from 63 VDC to 400 VDC. Size Codes from 1812 to 2824.

Special Features

- Size codes 1812, 2220 and 2824, with PEN and encapsulated
- Operating temperature up to 125° C
- Self-healing
- Suitable for lead-free soldering
- According to RoHS 2011/65/EU

Typical Applications

For general DC-applications e.g.

- By-pass
- Blocking
- Coupling and decoupling
- Timing

Construction

Dielectric:

Polyethylene-Naphthalate (PEN) film

Capacitor electrodes:

Vacuum-deposited

Internal construction:

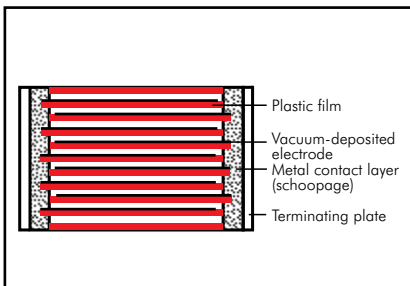

Encapsulation:

Solvent-resistant, flame-retardant plastic case, UL 94 V-0

Terminations:

Tinned plates.

Marking:

Colour: Black.

Electrical Data

Capacitance range:

0.01 μF to 1.0 μF

Rated voltages:

63 VDC, 100 VDC, 250 VDC, 400 VDC

Capacitance tolerances:

$\pm 20\%$, $\pm 10\%$ ($\pm 5\%$ available subject to special enquiry)

Operating temperature range:

-55° C to +125° C

Climatic test category:

55/125/21 according to IEC

Insulation resistance at +20° C:

U_r	U_{test}	$C \leq 0.33 \mu\text{F}$	$0.33 \mu\text{F} < C \leq 1.0 \mu\text{F}$
63 VDC 100 VDC	50 V 100 V	$\geq 3.75 \times 10^3 \text{ M}\Omega$ (mean value: $1 \times 10^4 \text{ M}\Omega$)	$\geq 1250 \text{ sec (M}\Omega \times \mu\text{F)}$ (mean value: 3000 sec)
$\geq 250 \text{ VDC}$	100 V	$\geq 1 \times 10^4 \text{ M}\Omega$ (mean value: $5 \times 10^4 \text{ M}\Omega$)	$\geq 3000 \text{ sec (M}\Omega \times \mu\text{F)}$ (mean value: 10000 sec)

Measuring time: 1 min.

Dissipation factors at +20° C: $\tan \delta$

at f	$C \leq 0.1 \mu\text{F}$	$0.1 \mu\text{F} < C \leq 1.0 \mu\text{F}$
1 kHz	$\leq 8 \times 10^{-3}$	$\leq 8 \times 10^{-3}$
10 kHz	$\leq 15 \times 10^{-3}$	$\leq 15 \times 10^{-3}$
100 kHz	$\leq 30 \times 10^{-3}$	-

Maximum pulse rise time: for pulses equal to the rated voltage

Capacitance μF	Pulse rise time V/ μsec max. operation/test			
	63 VDC	100 VDC	250 VDC	400 VDC
0.01 ... 0.022	30/300	35/350	40/400	35/350
0.033 ... 0.068	20/200	20/200	40/400	21/210
0.1 ... 0.22	10/100	10/100	12/120	-
0.33 ... 0.68	8/80	6/60	-	-
1.0	3,5/35	4/40	-	-

Dip Solder Test/Processing

Resistance to soldering heat:

Test Tb in accordance with DIN IEC

60068-2-58/DIN EN 60384-23.

Soldering bath temperature max. 260° C.

Soldering duration max. 5 sec.

Change in capacitance $\Delta C/C < 5\%$.

Soldering process:

Re-flow soldering (see temperature/time graphs page 13).

Packing

Available taped and reeled in blister pack.

Detailed taping information and graphs at the end of the catalogue.

For further details and graphs please refer to Technical Information.

Continuation

General Data

Capacitance	63 VDC/40 VAC*			100 VDC/63 VAC*		
	Size code	H ± 0.3	Part number	Size code	H ± 0.3	Part number
0.01 μF	1812	3.0	SMDNC02100KA00_____	1812	3.0	SMDND02100KA00_____
	2220	3.5	SMDNC02100QA00_____	2220	3.5	SMDND02100QA00_____
	2824	3.0	SMDNC02100TA00_____	2824	3.0	SMDND02100TA00_____
0.015 "	1812	3.0	SMDNC02150KA00_____	1812	3.0	SMDND02150KA00_____
	2220	3.5	SMDNC02150QA00_____	2220	3.5	SMDND02150QA00_____
	2824	3.0	SMDNC02150TA00_____	2824	3.0	SMDND02150TA00_____
0.022 "	1812	3.0	SMDNC02220KA00_____	1812	3.0	SMDND02220KA00_____
	2220	3.5	SMDNC02220QA00_____	2220	3.5	SMDND02220QA00_____
	2824	3.0	SMDNC02220TA00_____	2824	3.0	SMDND02220TA00_____
0.033 "	1812	3.0	SMDNC02330KA00_____	1812	3.0	SMDND02330KA00_____
	2220	3.5	SMDNC02330QA00_____	2220	3.5	SMDND02330QA00_____
	2824	3.0	SMDNC02330TA00_____	2824	3.0	SMDND02330TA00_____
0.047 "	1812	3.0	SMDNC02470KA00_____	1812	3.0	SMDND02470KA00_____
	2220	3.5	SMDNC02470QA00_____	2220	3.5	SMDND02470QA00_____
	2824	3.0	SMDNC02470TA00_____	2824	3.0	SMDND02470TA00_____
0.068 "	1812	3.0	SMDNC02680KA00_____	1812	3.0	SMDND02680KA00_____
	2220	3.5	SMDNC02680QA00_____	2220	3.5	SMDND02680QA00_____
	2824	3.0	SMDNC02680TA00_____	2824	3.0	SMDND02680TA00_____
0.1 μF	1812	4.0	SMDNC03100KB00_____	1812	4.0	SMDND03100KB00_____
	2220	3.5	SMDNC03100QA00_____	2220	3.5	SMDND03100QA00_____
	2824	3.0	SMDNC03100TA00_____	2824	3.0	SMDND03100TA00_____
0.15 "	1812	4.0	SMDNC03150KB00_____	1812	4.0	SMDND03150KB00_____
	2220	3.5	SMDNC03150QA00_____	2220	3.5	SMDND03150QA00_____
	2824	3.0	SMDNC03150TA00_____	2824	3.0	SMDND03150TA00_____
0.22 "	2220	3.5	SMDNC03220QA00_____	2220	3.5	SMDND03220QA00_____
	2824	3.0	SMDNC03220TA00_____	2824	3.0	SMDND03220TA00_____
0.33 "	2220	4.5	SMDNC03330QB00_____	2220	4.5	SMDND03330QB00_____
	2824	5.0	SMDNC03330TB00_____	2824	5.0	SMDND03330TB00_____
0.47 "	2220	4.5	SMDNC03470QB00_____	2220	4.5	SMDND03470QB00_____
	2824	5.0	SMDNC03470TB00_____	2824	5.0	SMDND03470TB00_____
0.68 "	2824	5.0	SMDNC03680TB00_____	2824	5.0	SMDND03680TB00_____
1.0 μF	2824	5.0	SMDNC04100TB00_____	2824	5.0	SMDND04100TB00_____

* AC voltage: $f = 50 \text{ Hz}$; $1.4 \times U_{\text{rms}} + \text{UDC} \leq U_r$

Dims in mm.

Part number completion:

Tolerance: 20 % = M
 10 % = K
 5 % = J
 Packing: bulk = S
 Pin length: none = 00
 Taped version see page 144.

Rights reserved to amend design data without prior notification.

Continuation page 22

Continuation

General Data

Capacitance	250 VDC/160 VAC*			400 VDC/200 VAC*		
	Size code	H ± 0.3	Part number	Size code	H ± 0.3	Part number
0.01 μF	2220 2824	3.5 3.0	SMDNF02100QA00_____ SMDNF02100TA00_____ SMDNF02100TA00_____ SMDNF02100TA00_____	2824	3.0	SMDNG02100TA00_____ SMDNG02100TA00_____ SMDNG02100TA00_____ SMDNG02100TA00_____
0.015 „	2220 2824	3.5 3.0	SMDNF02150QA00_____ SMDNF02150TA00_____ SMDNF02150TA00_____ SMDNF02150TA00_____	2824	3.0	SMDNG02150TA00_____ SMDNG02150TA00_____ SMDNG02150TA00_____ SMDNG02150TA00_____
0.022 „	2220 2824	3.5 3.0	SMDNF02220QA00_____ SMDNF02220TA00_____ SMDNF02220TA00_____ SMDNF02220TA00_____	2824	5.0	SMDNG02220TB00_____ SMDNG02220TB00_____ SMDNG02220TB00_____ SMDNG02220TB00_____
0.033 „	2220 2824	3.5 3.0	SMDNF02330QA00_____ SMDNF02330TA00_____ SMDNF02330TA00_____ SMDNF02330TA00_____	2824	5.0	SMDNG02330TB00_____ SMDNG02330TB00_____ SMDNG02330TB00_____ SMDNG02330TB00_____
0.047 „	2220 2824	3.5 3.0	SMDNF02470QA00_____ SMDNF02470TA00_____ SMDNF02470TA00_____ SMDNF02470TA00_____	2824	5.0	SMDNG02470TB00_____ SMDNG02470TB00_____ SMDNG02470TB00_____ SMDNG02470TB00_____
0.068 „	2220 2824	4.5 3.0	SMDNF02680QB00_____ SMDNF02680TA00_____ SMDNF02680TA00_____ SMDNF02680TA00_____			
0.1 μF	2220 2824	4.5 5.0	SMDNF03100QB00_____ SMDNF03100TB00_____ SMDNF03100TB00_____ SMDNF03100TB00_____			
0.15 „	2824	5.0	SMDNF03150TB00_____ SMDNF03150TB00_____ SMDNF03150TB00_____ SMDNF03150TB00_____			

* AC voltage: $f = 50 \text{ Hz}$; $1.4 \times U_{\text{rms}} + \text{UDC} \leq U_r$

Dims in mm.

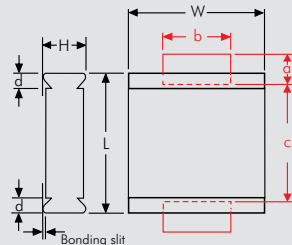

Part number completion:	
Tolerance:	20 % = M
	10 % = K
	5 % = J
Packing:	bulk = S
Pin length:	none = 00
Taped version see page 144.	

Size code	L ±0.3	W ±0.3	d	a min.	b min.	c max.
1812	4.8	3.3	0.5	1.2	3.5	3.5
2220	5.7	5.1	0.5	1.2	4	4.5
2824	7.2	6.1	0.5	1.2	4	6.5

Rights reserved to amend design data without prior notification.

Metallized Polyphenylene-Sulphide (PPS) SMD Film Capacitors with Box Encapsulation. Capacitances from 0.01 μF to 2.2 μF . Rated Voltages from 63 VDC to 1000 VDC. Size Codes from 1812 to 6054.

Special Features

- Size codes 1812, 2220, 2824, 4030, 5040 and 6054 with PPS and encapsulated
- Operating temperature up to 140° C
- Self-healing
- Suitable for lead-free soldering
- Low dissipation factor
- Low dielectric absorption
- Very constant capacitance value versus temperature
- According to RoHS 2011/65/EU

Typical Applications

For general applications in high temperature circuits e.g.

- By-pass
- Blocking
- Coupling and decoupling
- Timing
- Filtering
- Oscillating circuits

Construction

Dielectric:

Polyphenylene-sulphide (PPS) film

Capacitor electrodes:

Vacuum-deposited

Internal construction:

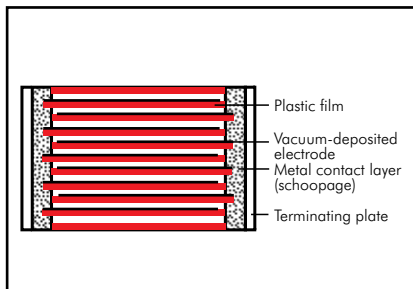

Encapsulation:

Solvent-resistant, flame-retardant plastic case, UL 94 V-0

Terminations:

Tinned plates.

Marking:

Box colour: Black.

Electrical Data

Capacitance range: 0.01 μF to 2.2 μF

Rated voltages:

63 VDC, 100 VDC, 250 VDC, 400 VDC, 630 VDC, 1000 VDC

Capacitance tolerances:

$\pm 20\%$, $\pm 10\%$ ($\pm 5\%$ available subject to special enquiry)

Operating temperature range:

-55°C to $+140^\circ\text{C}$

Climatic test category:

55/140/56 in accordance with IEC

Insulation resistance at $+20^\circ\text{C}$:

U_r	U_{test}	$C \leq 0.33 \mu\text{F}$	$0.33 \mu\text{F} < C \leq 2.2 \mu\text{F}$
63 VDC 100 VDC	50 V 100 V	$\geq 1 \times 10^4 \text{ M}\Omega$ (mean value: $3 \times 10^4 \text{ M}\Omega$)	$\geq 3000 \text{ sec (M}\Omega \times \mu\text{F)}$ (mean value: 6000 sec)
$\geq 250 \text{ VDC}$	100 V	$\geq 3 \times 10^4 \text{ M}\Omega$ (mean value: $6 \times 10^4 \text{ M}\Omega$)	$\geq 6000 \text{ sec (M}\Omega \times \mu\text{F)}$ (mean value: 12000 sec)

Measuring time: 1 min.

Dissipation factors at $+20^\circ\text{C}$: $\tan \delta$

at f	$C \leq 0.1 \mu\text{F}$	$0.1 \mu\text{F} < C \leq 1.0 \mu\text{F}$	$C > 1.0 \mu\text{F}$
1 kHz	$\leq 15 \times 10^{-4}$	$\leq 20 \times 10^{-4}$	$\leq 20 \times 10^{-4}$
10 kHz	$\leq 20 \times 10^{-4}$	$\leq 25 \times 10^{-4}$	-
100 kHz	$\leq 50 \times 10^{-4}$	-	-

Maximum pulse rise time: for pulses equal to the rated voltage

Capacitance μF	Pulse rise time V/ μsec max. operation/test					
	63 VDC	100 VDC	250 VDC	400 VDC	630 VDC	1000 VDC
0.01 ... 0.022	25/250	25/250	30/300	35/350	40/400	45/450
0.033 ... 0.068	15/150	15/150	20/200	25/250	28/280	32/320
0.1 ... 0.22	10/100	10/100	12/120	15/150	-	-
0.33 ... 0.68	5/50	5/50	6/60	8/80	-	-
1.0 ... 2.2	3/30	3/30	-	-	-	-

Dip Solder Test/Processing

Resistance to soldering heat:

Test Tb in accordance with DIN IEC

60068-2-58/DIN EN 60384-20.

Soldering bath temperature max. 260°C .

Soldering duration max. 5 sec.

Change in capacitance $\Delta C/C < 5\%$.

Soldering process:

Re-flow soldering (see temperature/time graphs page 13).

Packing

Available taped and reeled in blister pack.

Detailed taping information and graphs at the end of the catalogue.

For further details and graphs please refer to Technical Information.

Continuation

General Data

Capacitance	63 VDC/40 VAC*			100 VDC/63 VAC*			250 VDC/160 VAC*						
	Size code	H ± 0.3	Part number	Size code	H ± 0.3	Part number	Size code	H ± 0.3	Part number				
0.01 μ F	1812	3.0	SMDIC02100KA00_____	1812	3.0	SMDID02100KA00_____	2220	3.5	SMDIF02100QA00_____				
	2220	3.5	SMDIC02100QA00_____	2220	3.5	SMDID02100QA00_____							
0.015 "	1812	3.0	SMDIC02150KA00_____	1812	3.0	SMDID02150KA00_____	2220	3.5	SMDIF02150QA00_____				
	2220	3.5	SMDIC02150QA00_____	2220	3.5	SMDID02150QA00_____							
0.022 "	1812	3.0	SMDIC02220KA00_____	1812	3.0	SMDID02220KA00_____	2220	3.5	SMDIF02220QA00_____				
	2220	3.5	SMDIC02220QA00_____	2220	3.5	SMDID02220QA00_____		2824	3.0	SMDIF02220TA00_____			
0.033 "	1812	3.0	SMDIC02330KA00_____	1812	3.0	SMDID02330KA00_____	2824	3.0	SMDIF02330TA00_____				
	2220	3.5	SMDIC02330QA00_____	2220	3.5	SMDID02330QA00_____		4030	5.0	SMDIF02330VA00_____			
	2824	3.0	SMDIC02330TA00_____	2824	3.0	SMDID02330TA00_____							
0.047 "	1812	3.0	SMDIC02470KA00_____	1812	3.0	SMDID02470KA00_____	2824	5.0	SMDIF02470TB00_____				
	2220	3.5	SMDIC02470QA00_____	2220	3.5	SMDID02470QA00_____		4030	5.0	SMDIF02470VA00_____			
	2824	3.0	SMDIC02470TA00_____	2824	3.0	SMDID02470TA00_____							
0.068 "	1812	3.0	SMDIC02680KA00_____	2220	3.5	SMDID02680QA00_____	2824	5.0	SMDIF02680TB00_____				
	2220	3.5	SMDIC02680QA00_____	2824	3.0	SMDID02680TA00_____		4030	5.0	SMDIF02680VA00_____			
	2824	3.0	SMDIC02680TA00_____										
0.1 μ F	1812	3.0	SMDIC03100KA00_____	2220	3.5	SMDID03100QA00_____	2824	5.0	SMDIF03100TB00_____				
	2220	3.5	SMDIC03100QA00_____	2824	3.0	SMDID03100TA00_____		4030	5.0	SMDIF03100VA00_____			
	2824	3.0	SMDIC03100TA00_____						5040	6.0	SMDIF03100XA00_____		
0.15 "	1812	4.0	SMDIC03150KB00_____	2824	3.0	SMDID03150TA00_____	4030	5.0	SMDIF03150VA00_____				
	2220	3.5	SMDIC03150QA00_____					5040	6.0	SMDIF03150XA00_____			
	2824	3.0	SMDIC03150TA00_____					6054	7.0	SMDIF03150YA00_____			
0.22 "	2220	4.5	SMDIC03220QB00_____	2220	4.5	SMDID03220QB00_____	4030	5.0	SMDIF03220VA00_____				
		5.0	SMDIC03220TB00_____					2824	5.0	SMDID03220TB00_____	5040	6.0	SMDIF03220XA00_____
											6054	7.0	SMDIF03220YA00_____
0.33 "	2220	4.5	SMDIC03330QB00_____	2824	5.0	SMDID03330TB00_____	5040	6.0	SMDIF03330XA00_____				
		5.0	SMDIC03330TB00_____					4030	5.0	SMDID03330VA00_____	6054	7.0	SMDIF03330YA00_____
		5.0	SMDIC03330VA00_____										
0.47 "	2220	4.5	SMDIC03470QB00_____	2824	5.0	SMDID03470TB00_____	6054	7.0	SMDIF03470YA00_____				
		5.0	SMDIC03470TB00_____										
		4030	5.0							SMDIC03470VA00_____			
0.68 "	2824	5.0	SMDIC03680TB00_____	4030	5.0	SMDID03680VA00_____							
			4030				5.0	SMDIC03680VA00_____					
1.0 μ F	2824	5.0	SMDIC04100TB00_____	5040	6.0	SMDID04100XA00_____							
		4030	5.0				SMDIC04100VA00_____						
		5040	6.0				SMDIC04100XA00_____						
1.5 "	4030	5.0	SMDIC04150VA00_____	6054	7.0	SMDID04150YA00_____							
		5040	6.0				SMDIC04150XA00_____						
2.2 "	6054	7.0	SMDIC04220YA00_____	6054	7.0	SMDID04220YA00_____							

Part number completion:
Tolerance: 20 % = M
 10 % = K
 5 % = J
Packing: bulk = S
Pin length: none = 00
Taped version see page 144.

* AC voltages: $f \leq 400$ Hz; $1.4 \times U_{rms} + UDC \leq U_r$

Dims. in mm.

Rights reserved to amend design data without prior notification.

Continuation page 25

Continuation

General Data

Capacitance	400 VDC/200 VAC*			630 VDC/300 VAC*			1000 VDC/400 VAC*		
	Size code	H ± 0.3	Part number	Size code	H ± 0.3	Part number	Size code	H ± 0.3	Part number
0.01 μF				5040	6.0	SMDIJ02100XA00_	5040	6.0	SMDIO12100XA00_
0.015 "				5040	6.0	SMDIJ02150XA00_	5040	6.0	SMDIO12150XA00_
0.022 "	4030 5040	5.0 6.0	SMDIG02220VA00_ SMDIG02220XA00_	5040	6.0	SMDIJ02220XA00_	6054	7.0	SMDIO12220YA00_
0.033 "	4030 5040	5.0 6.0	SMDIG02330VA00_ SMDIG02330XA00_	5040	6.0	SMDIJ02330XA00_	6054	7.0	SMDIO12330YA00_
0.047 "	4030 5040	5.0 6.0	SMDIG02470VA00_ SMDIG02470XA00_	5040	6.0	SMDIJ02470XA00_			
0.068 "	4030 5040	5.0 6.0	SMDIG02680VA00_ SMDIG02680XA00_	6054	7.0	SMDIJ02680YA00_			
0.1 μF	4030 5040 6054	5.0 6.0 7.0	SMDIG03100VA00_ SMDIG03100XA00_ SMDIG03100YA00_						
0.15 "	5040 6054	6.0 7.0	SMDIG03150XA00_ SMDIG03150YA00_						
0.22 "	6054	7.0	SMDIG03220YA00_						
0.33 "	6054	7.0	SMDIG03330YA00_						

* AC voltages: $f \leq 400 \text{ Hz}$; $1.4 \times U_{\text{rms}} + U_{\text{DC}} \leq U_{\text{r}}$

 New value

Dims. in mm.

Solder pad recommendation

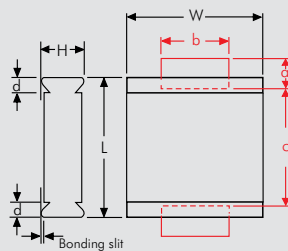

Part number completion:

Tolerance: 20 % = M

10 % = K

5 % = J

Packing: bulk = S

Pin length: none = 00

Taped version see page 144.

Size code	L ±0.3	W ±0.3	d	a min.	b min.	c max.
1812	4.8	3.3	0.5	1.2	3.5	3.5
2220	5.7	5.1	0.5	1.2	4	4.5
2824	7.2	6.1	0.5	1.2	4	6.5
4030	10.2	7.6	0.5	2.5	6	9
5040	12.7	10.2	0.7	2.5	6	11.5
6054	15.3	13.7	0.7	2.5	6	14

Rights reserved to amend design data without prior notification.

WIMA Miniature Capacitors in PCM 2.5 mm



WIMA FKP 02

WIMA MKS 02

WIMA plastic film capacitors in PCM 2.5 mm are available in metallized, self-healing version WIMA MKS 02 or in pulse duty film and foil versions WIMA FKP 02. As a dielectric, Polyester or Polypropylene film is used. The capacitance range includes values of 100 pF through 1.0 μ F and voltage ratings of 50 VDC, 63 VDC, 100 VDC, 250 VDC and 400 VDC.

The realization of the smallest plastic film capacitors in the world has been made possible by the use of ultra-thin plastic film in thicknesses of 0.8 μ m and below. The film processing with highly sensitive machines requires a high degree of experience and technical know-how.

The WIMA series with PCM 2.5 mm are contacted at the end surfaces and have very low self-inductance due to the small pin spacing of the capacitor and its fully contacted electrodes. Furthermore, the pulse and current loading capacities basically increase, the smaller the PCM can be designed, because – provided that the thickness of the film is the same – a longer band length is needed to achieve a particular capacitance value.

WIMA capacitors are produced with the proven box technology using solvent-resistant, flame-retardant plastic cases according to UL 94 V-0. They are environmentally compatible with the RoHS 2011/65/EU guidelines of the European Union.

WIMA subminiature capacitors in PCM 2.5 mm are outstandingly suitable as reservoir and decoupling capacitors for high-speed digital circuits and for HF decoupling in the field of high frequencies. Due to their excellent electrical properties they can replace ceramic capacitors in applications where quality and reliability are required. Due to their reduced dimensions they open up new possibilities for use in applications with limited space requirements and high package density.

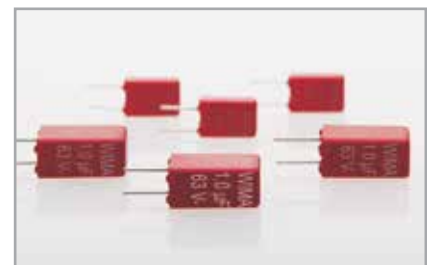

**Polypropylene (PP) Film/Foil Capacitors for Pulse Applications in PCM 2.5 mm.
Capacitances from 100 pF to 0.01 µF. Rated Voltages from 63 VDC to 400 VDC.**

Special Features

- Pulse duty construction
- PCM 2.5 mm
- Close tolerances up to $\pm 2.5\%$
- Very low dissipation factor
- Negative capacitance change versus temperature
- Very low dielectric absorption
- According to RoHS 2011/65/EU

Typical Applications

For high frequency applications e.g.

- Sample and hold
- Timing
- LC-Filtering
- Oscillating circuits
- Audio equipment

Construction

Dielectric:

Polypropylene (PP) film

Capacitor electrodes:

Metal foil

Internal construction:

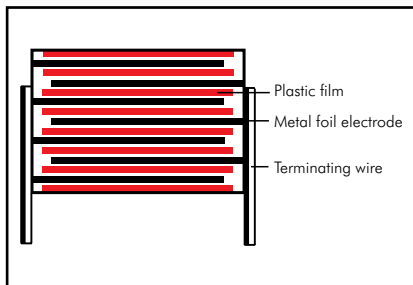

Encapsulation:

Solvent-resistant, flame-retardant plastic case with epoxy resin seal, UL 94 V-0

Terminations:

Tinned wire.

Marking:

Colour: Red. Marking: Black.

Epoxy resin seal: Yellow

Electrical Data

Capacitance range:

100 pF to 0.01 µF (E12-values on request)

Rated voltages:

63 VDC, 100 VDC, 250 VDC, 400 VDC

Capacitance tolerances:

$\pm 20\%$, $\pm 10\%$, $\pm 5\%$, $\pm 2.5\%$

Operating temperature range:

-55°C to $+100^{\circ}\text{C}$

Test specifications:

In accordance with IEC 60384-13

Climatic test category:

55/100/21 in accordance with IEC

Insulation resistance at $+20^{\circ}\text{C}$:

$\geq 5 \times 10^5 \text{ M}\Omega$

(mean value: $1 \times 10^6 \text{ M}\Omega$)

Measuring voltage:

$U_r = 63 \text{ V}$; $U_{\text{test}} = 50 \text{ V}/1 \text{ min.}$

$U_r \geq 100 \text{ V}$; $U_{\text{test}} = 100 \text{ V}/1 \text{ min.}$

Test voltage: $2 U_r$, 2 sec.

Maximum pulse rise time:

1000 V/ μsec for pulses equal to the rated voltage

Dielectric absorption:

0.05%

Temperature coefficient:

$-200 \times 10^{-6}/^{\circ}\text{C}$ (typical)

Dissipation factors at $+20^{\circ}\text{C}$: $\tan \delta$

at f	$C \leq 0.01 \mu\text{F}$
1 kHz	$\leq 4 \times 10^{-4}$
10 kHz	$\leq 4 \times 10^{-4}$
100 kHz	$\leq 6 \times 10^{-4}$

Voltage derating:

A voltage derating factor of 1.35 % per K must be applied from $+85^{\circ}\text{C}$ for DC voltages and from $+75^{\circ}\text{C}$ for AC voltages.

Reliability:

Operational life $> 300\,000$ hours

Failure rate $< 5 \text{ fit}$ ($0.5 \times U_r$ and 40°C)

Mechanical Tests

Pull test on pins:

10 N in direction of pins according to IEC 60068-2-21

Vibration:

6 hours at 10...2000 Hz and 0.75 mm displacement amplitude or 10 g in accordance with IEC 60068-2-6

Low air density:

1kPa = 10 mbar in accordance with IEC 60068-2-13

Bump test:

4000 bumps at $390 \text{ m}/\text{sec}^2$ in accordance with IEC 60068-2-29

Packing

Available taped and reeled.

Detailed taping information and graphs at the end of the catalogue.

For further details and graphs please refer to Technical Information.

Continuation

General Data

Capacitance	63 VDC/40 VAC*					100 VDC/63 VAC*				
	W	H	L	PCM**	Part number	W	H	L	PCM**	Part number
100 pF	2.5	7	4.6	2.5	FKPOC001000B00_____	2.5	7	4.6	2.5	FKPOD001000B00_____
150 "	2.5	7	4.6	2.5	FKPOC001500B00_____	2.5	7	4.6	2.5	FKPOD001500B00_____
220 "	2.5	7	4.6	2.5	FKPOC002200B00_____	2.5	7	4.6	2.5	FKPOD002200B00_____
330 "	2.5	7	4.6	2.5	FKPOC003300B00_____	2.5	7	4.6	2.5	FKPOD003300B00_____
470 "	2.5	7	4.6	2.5	FKPOC004700B00_____	2.5	7	4.6	2.5	FKPOD004700B00_____
680 "	2.5	7	4.6	2.5	FKPOC006800B00_____	2.5	7	4.6	2.5	FKPOD006800B00_____
1000 pF	2.5	7	4.6	2.5	FKPOC011000B00_____	2.5	7	4.6	2.5	FKPOD011000B00_____
1500 "	2.5	7	4.6	2.5	FKPOC011500B00_____	2.5	7	4.6	2.5	FKPOD011500B00_____
2200 "	3	7.5	4.6	2.5	FKPOC012200C00_____	3	7.5	4.6	2.5	FKPOD012200C00_____
3300 "	3.8	8.5	4.6	2.5	FKPOC013300D00_____	3.8	8.5	4.6	2.5	FKPOD013300D00_____
4700 "	4.6	9	4.6	2.5	FKPOC014700E00_____	4.6	9	4.6	2.5	FKPOD014700E00_____
6800 "	4.6	9	4.6	2.5	FKPOC016800E00_____	4.6	9	4.6	2.5	FKPOD016800E00_____
0.01 µF	5.5	10	4.6	2.5	FKPOC021000F00_____	5.5	10	4.6	2.5	FKPOD021000F00_____

Capacitance	250 VDC/160 VAC*					400 VDC/200 VAC*				
	W	H	L	PCM**	Part number	W	H	L	PCM**	Part number
100 pF	2.5	7	4.6	2.5	FKPOF001000B00_____	2.5	7	4.6	2.5	FKPOG001000B00_____
150 "	2.5	7	4.6	2.5	FKPOF001500B00_____	2.5	7	4.6	2.5	FKPOG001500B00_____
220 "	2.5	7	4.6	2.5	FKPOF002200B00_____	2.5	7	4.6	2.5	FKPOG002200B00_____
330 "	2.5	7	4.6	2.5	FKPOF003300B00_____	2.5	7	4.6	2.5	FKPOG003300B00_____
470 "	2.5	7	4.6	2.5	FKPOF004700B00_____	2.5	7	4.6	2.5	FKPOG004700B00_____
680 "	2.5	7	4.6	2.5	FKPOF006800B00_____	3	7.5	4.6	2.5	FKPOG006800C00_____
1000 pF	2.5	7	4.6	2.5	FKPOF011000B00_____	3.8	8.5	4.6	2.5	FKPOG011000D00_____
1500 "	3	7.5	4.6	2.5	FKPOF011500C00_____	4.6	9	4.6	2.5	FKPOG011500E00_____
2200 "	3.8	8.5	4.6	2.5	FKPOF012200D00_____	4.6	9	4.6	2.5	FKPOG012200E00_____
3300 "	4.6	9	4.6	2.5	FKPOF013300E00_____	5.5	10	4.6	2.5	FKPOG013300F00_____
4700 "	5.5	10	4.6	2.5	FKPOF014700F00_____					

* AC voltage: $f \leq 400 \text{ Hz}$; $1.4 \times U_{\text{rms}} + U_{\text{DC}} \leq U_r$

** PCM = Printed circuit module = pin spacing

Dims. in mm.

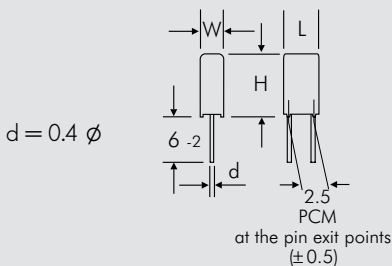

Part number completion:	
Tolerance:	20 % = M
	10 % = K
	5 % = J
	2.5 % = H
Packing:	bulk = S
Pin length:	6-2 = SD
Taped version see page 145.	

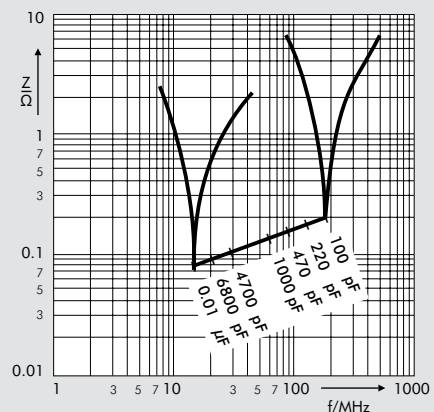

Impedance change with frequency (general guide).

Rights reserved to amend design data without prior notification.

The values of the WIMA FKS 02 and WIMA FKM 02 ranges according to the main catalogue 2009 are still available on request.

Metallized Polyester (PET) Capacitors in PCM 2.5 mm. Capacitances from 3300 pF to 1.0 µF. Rated Voltages from 50 VDC to 250 VDC.

Special Features

- High volume/capacitance ratio and reduced base
- PCM 2.5 mm
- Self-healing
- According to RoHS 2011/65/EU

Typical Applications

For general DC-applications e.g.

- By-pass
- Blocking
- Coupling and decoupling
- Timing

Construction

Dielectric:

Polyethylene-terephthalate (PET) film

Capacitor electrodes:

Vacuum-deposited

Internal construction:

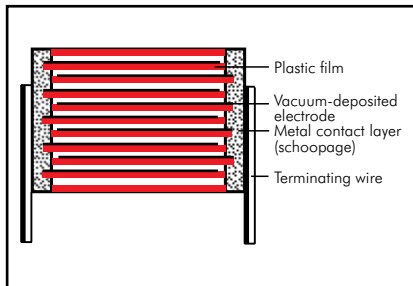

Encapsulation:

Solvent-resistant, flame-retardant plastic case with epoxy resin seal, UL 94 V-0

Terminations:

Tinned wire.

Marking:

Colour: Red. Marking: Silver.

Epoxy resin seal: Yellow

Electrical Data

Capacitance range:

3300 pF to 1.0 µF (E12-values on request)

Rated voltages:

50 VDC, 63 VDC, 100 VDC, 250 VDC

Capacitance tolerances:

±20%, ±10% (±5% available subject to special enquiry)

Operating temperature range:

-55° C to +100° C

Test specifications:

In accordance with IEC 60384-2

Climatic test category:

55/100/21 in accordance with IEC

Insulation resistance at +20° C:

U_r	U_{test}	$C \leq 0.33 \mu F$	$0.33 \mu F < C \leq 1.0 \mu F$
50 VDC	10 V	$\geq 3.75 \times 10^3 M\Omega$ (mean value: $1 \times 10^4 M\Omega$)	$\geq 1250 \text{ sec} (M\Omega \times \mu F)$ (mean value: 3000 sec)
63 VDC	50 V	$\geq 3.75 \times 10^3 M\Omega$ (mean value: $1 \times 10^4 M\Omega$)	$\geq 1250 \text{ sec} (M\Omega \times \mu F)$ (mean value: 3000 sec)
$\geq 100 \text{ VDC}$	100 V	$\geq 1 \times 10^4 M\Omega$ (mean value: $2 \times 10^4 M\Omega$)	-

Measuring time: 1 min.

Test voltage: $1.6 U_r$, 2 sec.

Maximum pulse rise time:

Capacitance pF/µF	Pulse rise time V/µsec max. operation/test
3300 ... 6800	100 / 1000
0.01 ... 0.022	50 / 500
0.033 ... 0.068	30 / 300
0.1 ... 0.33	20 / 200
0.47 ... 1.0	15 / 150

for pulses equal to the rated voltage

Mechanical Tests

Pull test on pins:

10 N in direction of pins according to IEC 60068-2-21

Vibration:

6 hours at 10...2000 Hz and 0.75 mm displacement amplitude or 10 g in accordance with IEC 60068-2-6

Low air density:

1kPa = 10 mbar in accordance with IEC 60068-2-13

Bump test:

4000 bumps at 390 m/sec² in accordance with IEC 60068-2-29

Dissipation factors at +20° C: tan δ

at f	$C \leq 0.1 \mu F$	$0.1 \mu F < C \leq 1.0 \mu F$
1 kHz	$\leq 8 \times 10^{-3}$	$\leq 8 \times 10^{-3}$
10 kHz	$\leq 15 \times 10^{-3}$	$\leq 15 \times 10^{-3}$
100 kHz	$\leq 30 \times 10^{-3}$	-

Voltage derating:

A voltage derating factor of 1.25 % per K must be applied from +85° C for DC voltages and from +75° C for AC voltages.

Reliability:

Operational life > 300 000 hours

Failure rate < 2 fit ($0.5 \times U_r$ and 40° C)

Packing

Available taped and reeled.

Detailed taping information and graphs at the end of the catalogue.

For further details and graphs please refer to Technical Information.

Continuation

General Data

Capacitance	50 VDC/30 VAC*					63 VDC/40 VAC*				
	W	H	L	PCM**	Part number	W	H	L	PCM**	Part number
0.01 μ F						2.5	7	4.6	2.5	MKS0C021000B00_
0.015 "						2.5	7	4.6	2.5	MKS0C021500B00_
0.022 "						2.5	7	4.6	2.5	MKS0C022200B00_
0.033 "						2.5	7	4.6	2.5	MKS0C023300B00_
0.047 "						2.5	7	4.6	2.5	MKS0C024700B00_
0.068 "						2.5	7	4.6	2.5	MKS0C026800B00_
0.1 μ F						3	7.5	4.6	2.5	MKS0C031000C00_
0.15 "						3	7.5	4.6	2.5	MKS0C031500C00_
0.22 "						3	7.5	4.6	2.5	MKS0C032200C00_
0.33 "						3.8	8.5	4.6	2.5	MKS0C033300D00_
0.47 "						4.6	9	4.6	2.5	MKS0C034700E00_
0.68 "						5.5	10	4.6	2.5	MKS0C036800F00_
1.0 μ F	5.5	10	4.6	2.5	MKS0B041000F00_					

Capacitance	100 VDC/63 VAC*					250 VDC/160 VAC*				
	W	H	L	PCM**	Part number	W	H	L	PCM**	Part number
3300 pF						2.5	7	4.6	2.5	MKS0F013300B00_
4700 "						2.5	7	4.6	2.5	MKS0F014700B00_
6800 "						2.5	7	4.6	2.5	MKS0F016800B00_
0.01 μ F	2.5	7	4.6	2.5	MKS0D021000B00_	2.5	7	4.6	2.5	MKS0F021000B00_
0.015 "	2.5	7	4.6	2.5	MKS0D021500B00_	2.5	7	4.6	2.5	MKS0F021500B00_
0.022 "	2.5	7	4.6	2.5	MKS0D022200B00_	2.5	7	4.6	2.5	MKS0F022200B00_
0.033 "	2.5	7	4.6	2.5	MKS0D023300B00_	3	7.5	4.6	2.5	MKS0F023300C00_
0.047 "	2.5	7	4.6	2.5	MKS0D024700B00_	3.8	8.5	4.6	2.5	MKS0F024700D00_
0.068 "	2.5	7	4.6	2.5	MKS0D026800B00_	4.6	9	4.6	2.5	MKS0F026800E00_
0.1 μ F	3	7.5	4.6	2.5	MKS0D031000C00_	5.5	10	4.6	2.5	MKS0F031000F00_
0.15 "	3.8	8.5	4.6	2.5	MKS0D031500D00_					
0.22 "	4.6	9	4.6	2.5	MKS0D032200E00_					
0.33 "	5.5	10	4.6	2.5	MKS0D033300F00_					

* AC voltage: $f = 50 \text{ Hz}$; $1.4 \times U_{\text{rms}} + U_{\text{DC}} \leq U_r$

** PCM = Printed circuit module = pin spacing

Dims. in mm.

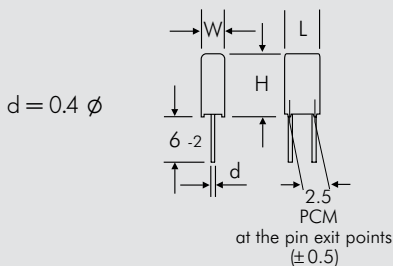

Part number completion:	
Tolerance:	20 % = M
	10 % = K
	5 % = J
Packing:	bulk = S
Pin length:	6-2 = SD
Taped version see page 145.	

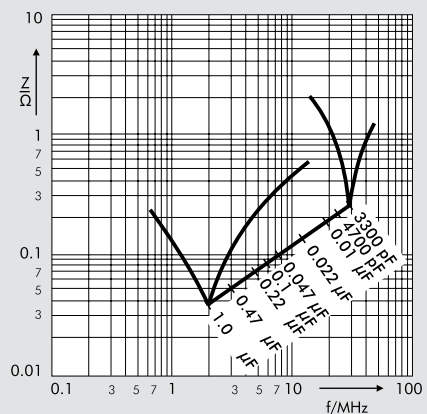

Impedance change with frequency (general guide).

Rights reserved to amend design data without prior notification.

WIMA Capacitors in PCM 5 - 15 mm with Pulse Duty Film/Foil Construction

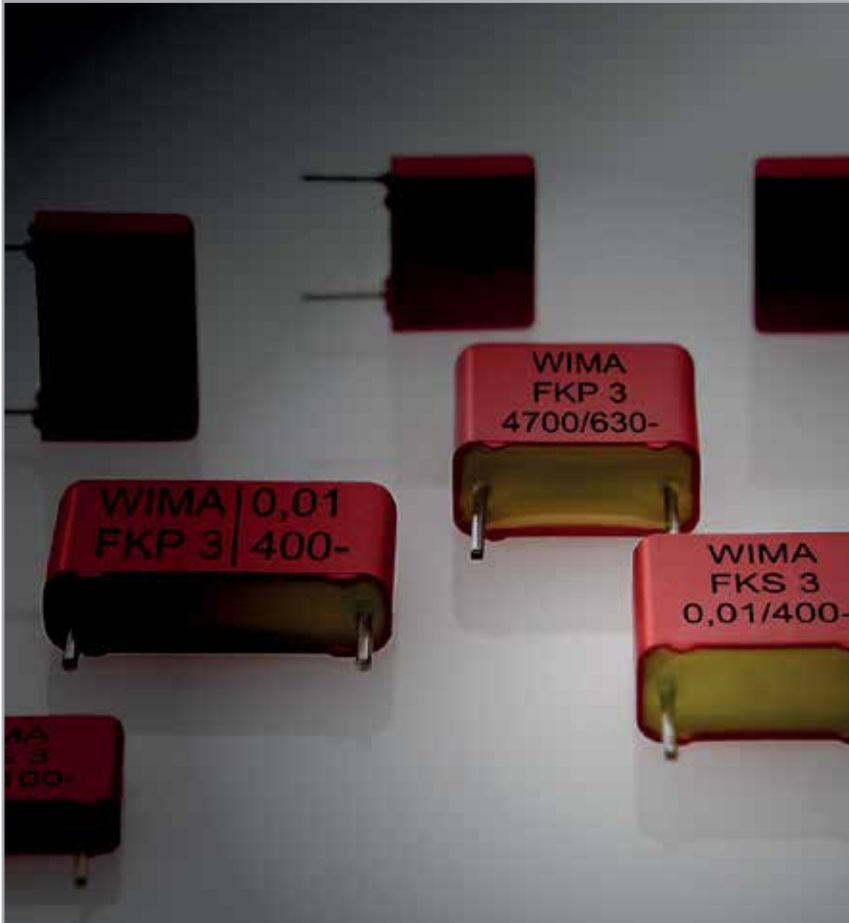

ined from the specific breakdown strength of the material.

WIMA film/foil capacitors in PCM 5 mm, 7.5 mm, 10 mm and 15 mm are available in two dielectric versions.

Capacitors with a Polyester dielectric (PET) are suitable for general applications such as coupling, decoupling and by-passing.

Polypropylene capacitors (PP) are used in the high frequency field. This includes resonant circuits, power supplies, deflection circuits, oscillator circuits and audio equipment.

WIMA capacitors are produced with the proven box technology using solvent-resistant, flame-retardant plastic cases according to UL 94 V-0. They are environmentally compatible with the RoHS 2011/65/EU regulations of the European Union.

WIMA FKS 2

WIMA FKP 2

WIMA FKS 3

WIMA FKP 3

In the case of film and foil types, the electrode is not applied as for the metalized capacitors, but is wound with the dielectric as a metal foil. Due to their lower series resistance, the components produced this way have excellent pulse and current carrying capability, as well as a very high insulation resistance.

The film/foil construction is mainly used for capacitors with smaller capacitance value. The advantage of this construction principle is the easy contactability of the metal foil electrodes and the good pulse strength. To avoid breakdowns caused by weak spots in the dielectric, the insulating film chosen is always thicker than theoretically required by the values which are deter-



Polyester (PET) Film/Foil Capacitors for Pulse Applications in PCM 5 mm. Capacitances from 1000 pF to 0.047 μ F. Rated Voltages from 63 VDC to 630 VDC.

Special Features

- Pulse duty construction
- According to RoHS 2011/65/EU

Typical Applications

For general DC-applications e.g.

- Coupling
- Decoupling

Construction

Dielectric:

Polyethylene-terephthalate (PET) film

Capacitor electrodes:

Metal foil

Internal construction:

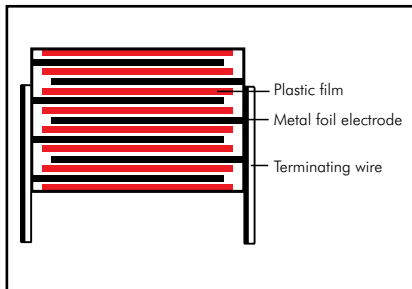

Encapsulation:

Solvent-resistant, flame-retardant plastic case with epoxy resin seal, UL 94 V-0

Terminations:

Tinned wire.

Marking:

Colour: Red. Marking: Silver.

Epoxy resin seal: Yellow.

Electrical Data

Capacitance range:

1000 pF to 0.047 μ F
(E12-values on request)

Rated voltages:

63 VDC, 100 VDC, 250 VDC, 400 VDC, 630 VDC

Capacitance tolerances:

$\pm 20\%$, $\pm 10\%$, $\pm 5\%$

Operating temperature range:

-55° C to $+100^{\circ}$ C

Test specifications:

In accordance with IEC 60384-11

Climatic test category:

55/100/56 in accordance with IEC

Insulation resistance at $+20^{\circ}$ C:

$\geq 3 \times 10^4$ M Ω

(mean value: 8×10^5 M Ω)

Measuring voltage: 100 V/1 min.

Test voltage: $2 U_r$, 2 sec.

Maximum pulse rise time:

1000 V/ μ sec for pulses equal to the rated voltage

Dissipation factors at $+20^{\circ}$ C: $\tan \delta$

at f	$C \leq 0.047 \mu\text{F}$
1 kHz	$\leq 7 \times 10^{-3}$
10 kHz	$\leq 15 \times 10^{-3}$
100 kHz	$\leq 20 \times 10^{-3}$

Voltage derating:

A voltage derating factor of 1.25 % per K must be applied from $+85^{\circ}$ C for DC voltages and from $+75^{\circ}$ C for AC voltages.

Reliability:

Operational life > 300 000 hours

Failure rate < 5 fit ($0.5 \times U_r$ and 40° C)

Mechanical Tests

Pull test on pins:

10 N in direction of pins according to IEC 60068-2-21

Vibration:

6 hours at 10...2000 Hz and 0.75 mm displacement amplitude or 10 g in accordance with IEC 60068-2-6

Low air density:

1kPa = 10 mbar in accordance with IEC 60068-2-13

Bump test:

4000 bumps at 390 m/sec² in accordance with IEC 60068-2-29

Packing

Available taped and reeled.

Detailed taping information and graphs at the end of the catalogue.

For further details and graphs please refer to Technical Information.

Continuation

General Data

Capacitance	63 VDC/40 VAC*					100 VDC/63 VAC*				
	W	H	L	PCM**	Part number	W	H	L	PCM**	Part number
1000 pF	2.5	6.5	7.2	5	FKS2C011001A00_____	2.5	6.5	7.2	5	FKS2D011001A00_____
1500 "	2.5	6.5	7.2	5	FKS2C011501A00_____	2.5	6.5	7.2	5	FKS2D011501A00_____
2200 "	2.5	6.5	7.2	5	FKS2C012201A00_____	2.5	6.5	7.2	5	FKS2D012201A00_____
3300 "	2.5	6.5	7.2	5	FKS2C013301A00_____	2.5	6.5	7.2	5	FKS2D013301A00_____
4700 "	2.5	6.5	7.2	5	FKS2C014701A00_____	2.5	6.5	7.2	5	FKS2D014701A00_____
6800 "	2.5	6.5	7.2	5	FKS2C016801A00_____	2.5	6.5	7.2	5	FKS2D016801A00_____
0.01 µF	3	7.5	7.2	5	FKS2C021001B00_____	3	7.5	7.2	5	FKS2D021001B00_____
0.015 "	3.5	8.5	7.2	5	FKS2C021501C00_____	3.5	8.5	7.2	5	FKS2D021501C00_____
0.022 "	4.5	9.5	7.2	5	FKS2C022201E00_____	4.5	9.5	7.2	5	FKS2D022201E00_____
0.033 "	5.5	11.5	7.2	5	FKS2C023301H00_____	5.5	11.5	7.2	5	FKS2D023301H00_____
0.047 "	7.2	13	7.2	5	FKS2C024701K00_____	7.2	13	7.2	5	FKS2D024701K00_____

Capacitance	250 VDC/160 VAC*					400 VDC/200 VAC*				
	W	H	L	PCM**	Part number	W	H	L	PCM**	Part number
1000 pF	2.5	6.5	7.2	5	FKS2F011001A00_____	2.5	6.5	7.2	5	FKS2G011001A00_____
1500 "	2.5	6.5	7.2	5	FKS2F011501A00_____	2.5	6.5	7.2	5	FKS2G011501A00_____
2200 "	2.5	6.5	7.2	5	FKS2F012201A00_____	2.5	6.5	7.2	5	FKS2G012201A00_____
3300 "	2.5	6.5	7.2	5	FKS2F013301A00_____	2.5	6.5	7.2	5	FKS2G013301A00_____
4700 "	2.5	6.5	7.2	5	FKS2F014701A00_____	2.5	6.5	7.2	5	FKS2G014701A00_____
6800 "	2.5	6.5	7.2	5	FKS2F016801A00_____	3	7.5	7.2	5	FKS2G016801B00_____
0.01 µF	3	7.5	7.2	5	FKS2F021001B00_____	3.5	8.5	7.2	5	FKS2G021001C00_____
0.015 "	3.5	8.5	7.2	5	FKS2F021501C00_____	4.5	9.5	7.2	5	FKS2G021501E00_____
0.022 "	4.5	9.5	7.2	5	FKS2F022201E00_____	5.5	11.5	7.2	5	FKS2G022201H00_____
0.033 "	5.5	11.5	7.2	5	FKS2F023301H00_____	7.2	13	7.2	5	FKS2G023301K00_____
0.047 "	7.2	13	7.2	5	FKS2F024701K00_____					

Capacitance	630 VDC/250 VAC*				
	W	H	L	PCM**	Part number
1000 pF	3	7.5	7.2	5	FKS2J011001B00_____
1500 "	3	7.5	7.2	5	FKS2J011501B00_____
2200 "	3	7.5	7.2	5	FKS2J012201B00_____
3300 "	3	7.5	7.2	5	FKS2J013301B00_____
4700 "	3.5	8.5	7.2	5	FKS2J014701C00_____
6800 "	4.5	9.5	7.2	5	FKS2J016801E00_____
0.01 µF	4.5	9.5	7.2	5	FKS2J021001E00_____
0.015 "	5.5	11.5	7.2	5	FKS2J021501H00_____
0.022 "	7.2	13	7.2	5	FKS2J022201K00_____

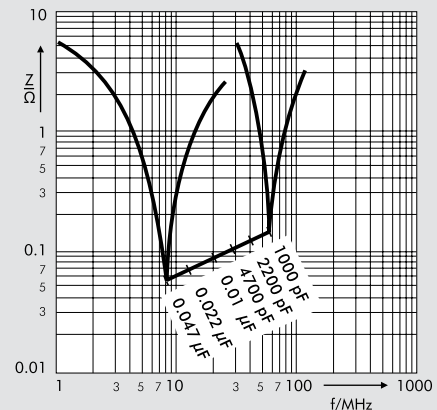

Impedance change with frequency (general guide).

Part number completion:	
Tolerance:	20 % = M
	10 % = K
	5 % = J
Packing:	bulk = S
Pin length:	6-2 = SD
Taped version see page 145.	

* AC voltage: $f = 50 \text{ Hz}$; $1.4 \times U_{\text{rms}} + \text{UDC} \leq U_r$

■ New ranges

** PCM = Printed circuit module = pin spacing

Dims. in mm.

$d = 0.5 \phi$

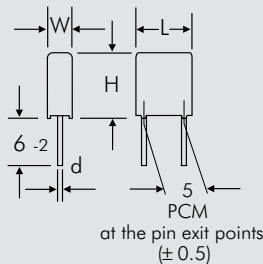

Rights reserved to amend design data without prior notification.

Continuation

General Data

Capacitance	63 VDC/40 VAC*					100 VDC/63 VAC*				
	W	H	L	PCM**	Part number	W	H	L	PCM**	Part number
100 pF	4.5	6	7.2	5	FKP2C001001D00_____	4.5	6	7.2	5	FKP2D001001D00_____
150 "	4.5	6	7.2	5	FKP2C001501D00_____	4.5	6	7.2	5	FKP2D001501D00_____
220 "	4.5	6	7.2	5	FKP2C002201D00_____	4.5	6	7.2	5	FKP2D002201D00_____
330 "	4.5	6	7.2	5	FKP2C003301D00_____	4.5	6	7.2	5	FKP2D003301D00_____
470 "	4.5	6	7.2	5	FKP2C004701D00_____	4.5	6	7.2	5	FKP2D004701D00_____
680 "	4.5	6	7.2	5	FKP2C006801D00_____	4.5	6	7.2	5	FKP2D006801D00_____
1000 pF	4.5	6	7.2	5	FKP2C011001D00_____	4.5	6	7.2	5	FKP2D011001D00_____
1500 "	4.5	6	7.2	5	FKP2C011501D00_____	4.5	6	7.2	5	FKP2D011501D00_____
2200 "	4.5	6	7.2	5	FKP2C012201D00_____	4.5	6	7.2	5	FKP2D012201D00_____
3300 "	4.5	6	7.2	5	FKP2C013301D00_____	5.5	7	7.2	5	FKP2D013301G00_____
4700 "	4.5	6	7.2	5	FKP2C014701D00_____	5.5	7	7.2	5	FKP2D014701G00_____
6800 "	4.5	6	7.2	5	FKP2C016801D00_____	5.5	7	7.2	5	FKP2D016801G00_____
0.01 µF	5.5	7	7.2	5	FKP2C021001G00_____	6.5	8	7.2	5	FKP2D021001I00_____
0.015 "	6.5	8	7.2	5	FKP2C021501I00_____	7.2	8.5	7.2	5	FKP2D021501J00_____
0.022 "	7.2	8.5	7.2	5	FKP2C022201J00_____	8.5	10	7.2	5	FKP2D022201L00_____
0.033 "	8.5	10	7.2	5	FKP2C023301L00_____					

Capacitance	250 VDC/160 VAC*					400 VDC/220 VAC*				
	W	H	L	PCM**	Part number	W	H	L	PCM**	Part number
100 pF	4.5	6	7.2	5	FKP2F001001D00_____	4.5	6	7.2	5	FKP2G001001D00_____
150 "	4.5	6	7.2	5	FKP2F001501D00_____	4.5	6	7.2	5	FKP2G001501D00_____
220 "	4.5	6	7.2	5	FKP2F002201D00_____	4.5	6	7.2	5	FKP2G002201D00_____
330 "	4.5	6	7.2	5	FKP2F003301D00_____	4.5	6	7.2	5	FKP2G003301D00_____
470 "	4.5	6	7.2	5	FKP2F004701D00_____	4.5	6	7.2	5	FKP2G004701D00_____
680 "	4.5	6	7.2	5	FKP2F006801D00_____	4.5	6	7.2	5	FKP2G006801D00_____
1000 pF	4.5	6	7.2	5	FKP2F011001D00_____	4.5	6	7.2	5	FKP2G011001D00_____
1500 "	4.5	6	7.2	5	FKP2F011501D00_____	4.5	6	7.2	5	FKP2G011501D00_____
2200 "	4.5	6	7.2	5	FKP2F012201D00_____	4.5	6	7.2	5	FKP2G012201D00_____
3300 "	5.5	7	7.2	5	FKP2F013301G00_____	5.5	7	7.2	5	FKP2G013301G00_____
4700 "	6.5	8	7.2	5	FKP2F014701I00_____	6.5	8	7.2	5	FKP2G014701I00_____
6800 "	6.5	8	7.2	5	FKP2F016801I00_____	7.2	8.5	7.2	5	FKP2G016801J00_____
0.01 µF	7.2	8.5	7.2	5	FKP2F021001J00_____	8.5	10	7.2	5	FKP2G021001L00_____
0.015 "	8.5	10	7.2	5	FKP2F021501L00_____					

* AC voltage: $f \leq 1000 \text{ Hz}$; $1.4 \times U_{\text{rms}} + U_{\text{DC}} \leq U_r$

** PCM = Printed circuit module = pin spacing.

E12 values and individual values available from 27 pF up on request.

Dims. in mm.

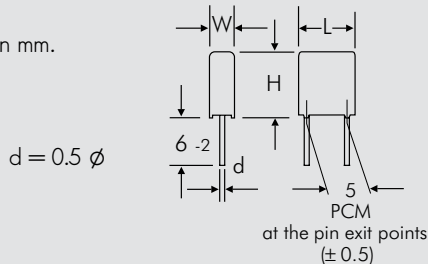

Part number completion:

- Tolerance: 20 % = M
- 10 % = K
- 5 % = J
- 2.5 % = H
- 2 % = G
- 1.5 % = F
- 1 % = E

Packing: bulk = S

Pin length: 6-2 = SD

Taped version see page 145.

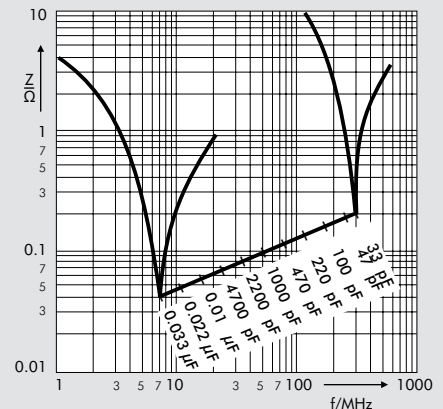

Impedance change with frequency (general guide).

Rights reserved to amend design data without prior notification.

Continuation

General Data

Capacitance	630 VDC/250 VAC*					800 VDC/250 VAC*				
	W	H	L	PCM**	Part number	W	H	L	PCM**	Part number
100 pF	4.5	6	7.2	5	FKP2J001001D00_	4.5	6	7.2	5	FKP2L001001D00_
150 "	4.5	6	7.2	5	FKP2J001501D00_	4.5	6	7.2	5	FKP2L001501D00_
220 "	4.5	6	7.2	5	FKP2J002201D00_	4.5	6	7.2	5	FKP2L002201D00_
330 "	4.5	6	7.2	5	FKP2J003301D00_	4.5	6	7.2	5	FKP2L003301D00_
470 "	4.5	6	7.2	5	FKP2J004701D00_	5.5	7	7.2	5	FKP2L004701G00_
680 "	4.5	6	7.2	5	FKP2J006801D00_	5.5	7	7.2	5	FKP2L006801G00_
1000 pF	4.5	6	7.2	5	FKP2J011001D00_	5.5	7	7.2	5	FKP2L011001G00_
1500 "	4.5	6	7.2	5	FKP2J011501D00_	5.5	7	7.2	5	FKP2L011501G00_
2200 "	5.5	7	7.2	5	FKP2J012201G00_	6.5	8	7.2	5	FKP2L012201I00_
3300 "	6.5	8	7.2	5	FKP2J013301I00_	7.2	8.5	7.2	5	FKP2L013301J00_
4700 "	6.5	8	7.2	5	FKP2J014701I00_	8.5	10	7.2	5	FKP2L014701L00_
6800 "	7.2	8.5	7.2	5	FKP2J016801J00_					
0.01 µF	8.5	10	7.2	5	FKP2J021001L00_					

Capacitance	1000 VDC/250 VAC*				
	W	H	L	PCM**	Part number
33 pF	4.5	6	7.2	5	FKP2O100331D00_
47 "	4.5	6	7.2	5	FKP2O100471D00_
68 "	4.5	6	7.2	5	FKP2O100681D00_
100 pF	4.5	6	7.2	5	FKP2O101001D00_
150 "	4.5	6	7.2	5	FKP2O101501D00_
220 "	4.5	6	7.2	5	FKP2O102201D00_
330 "	4.5	6	7.2	5	FKP2O103301D00_
470 "	5.5	7	7.2	5	FKP2O104701G00_
680 "	5.5	7	7.2	5	FKP2O106801G00_
1000 pF	6.5	8	7.2	5	FKP2O111001I00_
1500 "	7.2	8.5	7.2	5	FKP2O111501J00_
2200 "	8.5	10	7.2	5	FKP2O112201L00_

E12 values and individual values available from 27 pF up on request.

Dims. in mm.

Part number completion:	
Tolerance:	20 % = M
	10 % = K
	5 % = J
	2.5 % = H
	2 % = G
	1.5 % = F
	1 % = E
Packing:	bulk = S
Pin length:	6-2 = SD
Taped version see page 145.	

* AC voltage: $f \leq 1000 \text{ Hz}$; $1.4 \times U_{\text{rms}} + \text{UDC} \leq U_r$

** PCM = Printed circuit module = pin spacing.

Rights reserved to amend design data without prior notification.

Permissible AC voltage in relation to frequency at 10° C internal temperature rise (general guide).

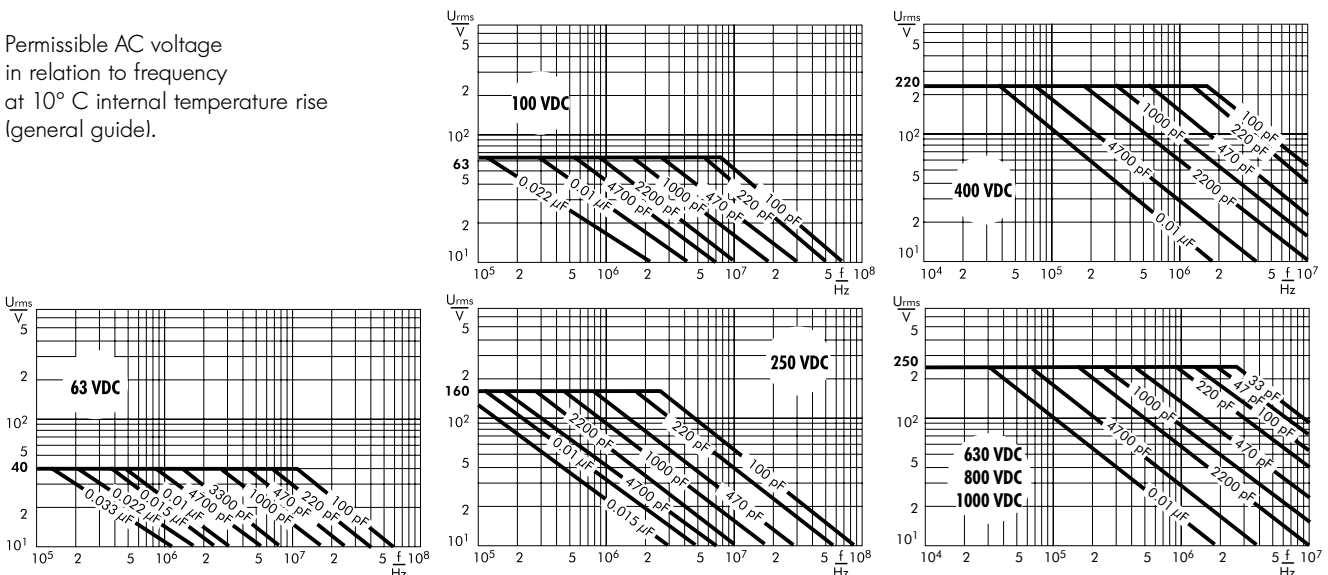

**Polyester (PET) Film/Foil Capacitors for Pulse Applications
in PCM 7.5 mm to 15 mm. Capacitances from 1000 pF to 0.22 µF.
Rated Voltages from 100 VDC to 630 VDC.**

Special Features

- Pulse duty construction
- According to RoHS 2011/65/EU

Typical Applications

For general DC-applications e.g.

- Coupling
- Decoupling

Construction

Dielectric:

Polyethylene-terephthalate (PET) film

Capacitor electrodes:

Metal foil

Internal construction:

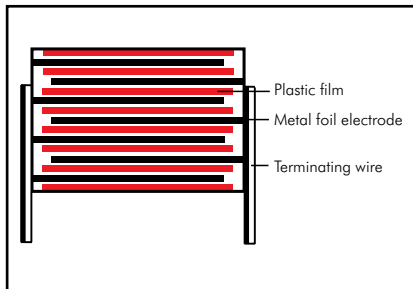

Encapsulation:

Solvent-resistant, flame-retardant plastic case with epoxy resin seal, UL 94 V-0

Terminations:

Tinned wire.

Marking:

Colour: Red. Marking: Black.
Epoxy resin seal: Yellow.

Electrical Data

Capacitance range:

1000 pF to 0.22 µF (E12-values on request)

Rated voltages:

100 VDC, 250 VDC, 400 VDC, 630 VDC

Capacitance tolerances:

± 20%, ± 10%, ± 5%,

Operating temperature range:

-55° C to +100° C

Test specifications:

In accordance with IEC 60384-11

Climatic test category:

55/100/56 in accordance with IEC

Insulation resistance at +20° C:

≥ 3 x 10⁴ MΩ

(mean value: 5 x 10⁵ MΩ)

Measuring voltage: 100 V/1 min.

Test voltage: 2 U_r, 2 sec.

Maximum pulse rise time:

1000 V/µsec for pulses equal to the rated voltage

Dissipation factors at +20° C: tan δ

at f	C ≤ 0.01 µF	0.01 µF < C ≤ 0.22 µF
1 kHz	≤ 8 x 10 ⁻³	≤ 8 x 10 ⁻³
10 kHz	≤ 15 x 10 ⁻³	≤ 20 x 10 ⁻³
100 kHz	≤ 20 x 10 ⁻³	≤ 25 x 10 ⁻³

Voltage derating:

A voltage derating factor of 1.25 % per K must be applied from +85° C for DC voltages and from +75° C for AC voltages.

Reliability:

Operational life > 300 000 hours

Failure rate < 5 fit (0.5 x U_r and 40° C)

Mechanical Tests

Pull test on pins:

10 N in direction of pins according to IEC 60068-2-21

Vibration:

6 hours at 10...2000 Hz and 0.75 mm displacement amplitude or 10 g in accordance with IEC 60068-2-6

Low air density:

1 kPa = 10 mbar in accordance with IEC 60068-2-13

Bump test:

4000 bumps at 390 m/sec² in accordance with IEC 60068-2-29

Packing

Available taped and reeled.

Detailed taping information and graphs at the end of the catalogue.

For further details and graphs please refer to Technical Information.

Continuation

General Data

Capacitance	100 VDC/63 VAC*					250 VDC/160 VAC*				
	W	H	L	PCM**	Part number	W	H	L	PCM**	Part number
1000 pF	3	8.5	10	7.5	FKS3D011002B00_____	3	8.5	10	7.5	FKS3F011002B00_____
1500 "	3	8.5	10	7.5	FKS3D011502B00_____	3	8.5	10	7.5	FKS3F011502B00_____
2200 "	3	8.5	10	7.5	FKS3D012202B00_____	3	8.5	10	7.5	FKS3F012202B00_____
3300 "	3	8.5	10	7.5	FKS3D013302B00_____	3	8.5	10	7.5	FKS3F013302B00_____
4700 "	3	8.5	10	7.5	FKS3D014702B00_____	3	8.5	10	7.5	FKS3F014702B00_____
						3	9	13	10	FKS3F014703A00_____
6800 "	3	8.5	10	7.5	FKS3D016802B00_____	3	8.5	10	7.5	FKS3F016802B00_____
						3	9	13	10	FKS3F016803A00_____
0.01 µF	3	8.5	10	7.5	FKS3D021002B00_____	3	9	13	10	FKS3F021003A00_____
	3	9	13	10	FKS3D021003A00_____					
0.015 "	3	8.5	10	7.5	FKS3D021502B00_____	4	9.5	13	10	FKS3F021503D00_____
	3	9	13	10	FKS3D021503A00_____					
0.022 "	3	8.5	10	7.5	FKS3D022202B00_____	5	11	13	10	FKS3F022203F00_____
	3	9	13	10	FKS3D022203A00_____					
0.033 "	4	9.5	13	10	FKS3D023303D00_____	6	12	13	10	FKS3F023303G00_____
0.047 "	4	9.5	13	10	FKS3D024703D00_____	6	12.5	18	15	FKS3F024704C00_____
0.068 "	5	11	13	10	FKS3D026803F00_____	7	14	18	15	FKS3F026804D00_____
0.1 µF	6	12	13	10	FKS3D031003G00_____	8	15	18	15	FKS3F031004F00_____
0.15 "	7	14	18	15	FKS3D031504D00_____	9	16	18	15	FKS3F031504J00_____
0.22 "	8	15	18	15	FKS3D032204F00_____					

* AC voltage: $f = 50 \text{ Hz}$; $1.4 \times U_{\text{rms}} + U_{\text{DC}} \leq U_r$

 New values

** PCM = Printed circuit module = pin spacing.

Dims. in mm.

The values of the WIMA FKM 3 range according to the main catalogue 2009 are still available on request.

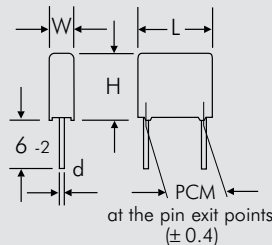

Part number completion:

Tolerance: 20 % = M

10 % = K

5 % = J

Packing: bulk = S

Pin length: 6-2 = SD

Taped version see page 145.

$d = 0.5 \phi$ if $W = 3$
 $d = 0.6 \phi$ if $W \geq 4$
 $d = 0.8 \phi$ if $PCM = 15$

} PCM 7.5 and 10

Rights reserved to amend design data without prior notification.

Continuation page 39

Continuation

General Data

Capacitance	400 VDC/250 VAC*					630 VDC/300 VAC*				
	W	H	L	PCM**	Part number	W	H	L	PCM**	Part number
1000 pF	3	9	13	10	FKS3G011003A00_____	3	9	13	10	FKS3J011003A00_____
1500 "	3	9	13	10	FKS3G011503A00_____	3	9	13	10	FKS3J011503A00_____
2200 "	3	9	13	10	FKS3G012203A00_____	3	9	13	10	FKS3J012203A00_____
3300 "	3	9	13	10	FKS3G013303A00_____	4	9.5	13	10	FKS3J013303D00_____
4700 "	3	9	13	10	FKS3G014703A00_____	4	9.5	13	10	FKS3J014703D00_____
6800 "	3	9	13	10	FKS3G016803A00_____	5	11	13	10	FKS3J016803F00_____
0.01 µF	4	9.5	13	10	FKS3G021003D00_____	6	12	13	10	FKS3J021003G00_____
0.015 "	5	11	13	10	FKS3G021503F00_____	6	12.5	18	15	FKS3J021504C00_____
0.022 "	6	12	13	10	FKS3G022203G00_____	7	14	18	15	FKS3J022204D00_____
0.033 "	6	12.5	18	15	FKS3G023304C00_____	8	15	18	15	FKS3J023304F00_____
0.047 "	7	14	18	15	FKS3G024704D00_____					
0.068 "	8	15	18	15	FKS3G026804F00_____					
0.1 µF	9	16	18	15	FKS3G031004J00_____					

* AC voltage: $f = 50 \text{ Hz}; 1.4 \times U_{\text{rms}} + \text{UDC} \leq U_r$

New ranges

** PCM = Printed circuit module = pin spacing.

Dims. in mm.

The values of the WIMA FKM 3 range according to the main catalogue 2009 are still available on request..

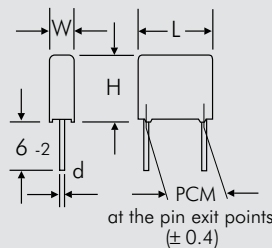

Part number completion:	
Tolerance:	20 % = M
	10 % = K
	5 % = J
Packing:	bulk = S
Pin length:	6-2 = SD
Taped version see page 145.	

$d = 0.5 \varnothing$ if $W = 3$
 $d = 0.6 \varnothing$ if $W \geq 4$
 $d = 0.8 \varnothing$ if $\text{PCM} = 15$

Rights reserved to amend design data without prior notification.

Permissible AC voltage in relation to frequency at 10° C internal temperature rise (general guide).

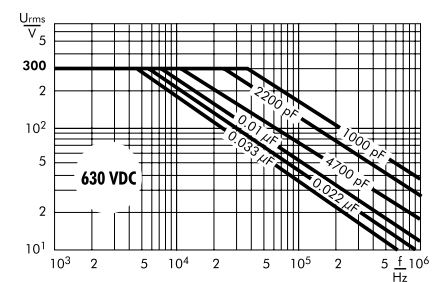
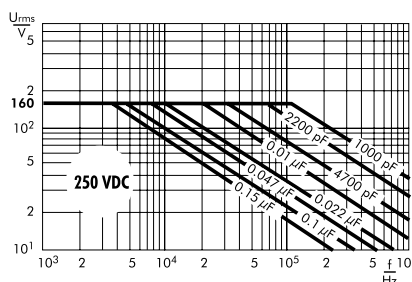
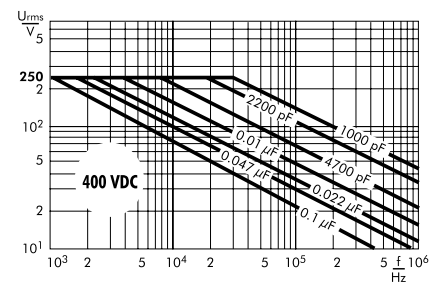
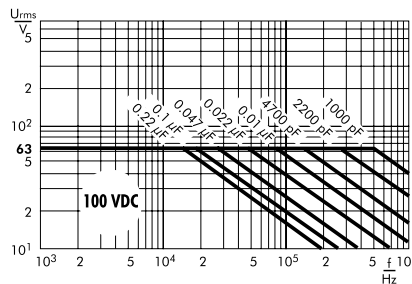

Polypropylene (PP) Film and Foil Capacitors for Pulse Applications in PCM 7.5 mm to 15 mm. Capacitances from 100 pF to 0.22 µF. Rated Voltages from 63 VDC to 1000 VDC.

Special Features

- Pulse duty construction
- Very low dissipation factor
- Negative capacitance change versus temperature
- Very low dielectric absorption
- According to RoHS 2011/65/EU

Typical Applications

For high frequency applications e.g.

- Sample and hold
- Timing
- LC-Filtering
- Oscillating circuits
- Audio equipment

Construction

Dielectric:

Polypropylene (PP) film

Capacitor electrodes:

Metal foil

Internal construction:

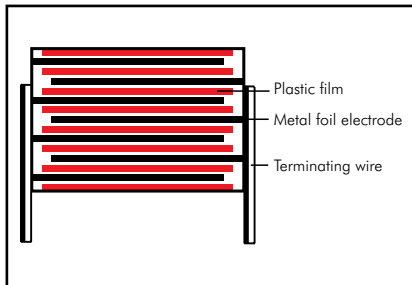

Encapsulation:

Solvent-resistant, flame-retardant plastic case with epoxy resin seal, UL 94 V-0

Terminations:

Tinned wire.

Marking:

Colour: Red. Marking: Black.

Epoxy resin seal: Yellow

Electrical Data

Capacitance range:

100 pF to 0.22 µF (E12-values on request)

Rated voltages:

63 VDC, 100 VDC, 250 VDC, 400 VDC, 630 VDC, 1000 VDC

Capacitance tolerances:

±20%, ±10%, ±5%

Operating temperature range:

-55° C to +100° C

Test specifications:

In accordance with IEC 60384-13

Climatic test category:

55/100/56 in accordance with IEC

Insulation resistance at +20° C:

≥ 5 x 10⁵ MΩ

(mean value: 1 x 10⁶ MΩ)

Measuring voltage:

U_r = 63 V; U_{test} = 50 V/1 min.

U_r ≥ 100 V; U_{test} = 100 V/1 min.

Test voltage: 2 U_r, 2 sec.

Maximum pulse rise time:

1000 V/µsec for pulses equal to the rated voltage

Dielectric absorption:

0.05 %

Temperature coefficient:

-200 x 10⁻⁶/° C (general guide)

Dissipation factors at +20° C: tan δ

at f	C ≤ 0.1 µF	0.1 µF < C ≤ 0.22 µF
1 kHz	≤ 4 x 10 ⁻⁴	≤ 3 x 10 ⁻⁴
10 kHz	≤ 5 x 10 ⁻⁴	≤ 6 x 10 ⁻⁴
100 kHz	≤ 10 x 10 ⁻⁴	-

Voltage derating:

A voltage derating factor of 1.35 % per K must be applied from +85° C for DC voltages and from +75° C for AC voltages.

Reliability:

Operational life > 300 000 hours

Failure rate < 5 fit (0.5 x U_r and 40° C)

Mechanical Tests

Pull test on pins:

10 N in direction of pins according to IEC 60068-2-21

Vibration:

6 hours at 10...2000 Hz and 0.75 mm displacement amplitude or 10 g in accordance with IEC 60068-2-6

Low air density:

1 kPa = 10 mbar in accordance with IEC 60068-2-13

Bump test:

4000 bumps at 390 m/sec² in accordance with IEC 60068-2-29

Packing

Available taped and reeled.

Detailed taping information and graphs at the end of the catalogue.

For further details and graphs please refer to Technical Information.

Continuation

General Data

Capacitance	63 VDC/40 VAC*					100 VDC/63 VAC*				
	W	H	L	PCM**	Part number	W	H	L	PCM**	Part number
100 pF						3	8.5	10	7.5	FKP3D001002B00_____
150 "						3	8.5	10	7.5	FKP3D001502B00_____
220 "						3	8.5	10	7.5	FKP3D002202B00_____
330 "						3	8.5	10	7.5	FKP3D003302B00_____
470 "						3	8.5	10	7.5	FKP3D004702B00_____
680 "						3	8.5	10	7.5	FKP3D006802B00_____
1000 pF						3	8.5	10	7.5	FKP3D011002B00_____
1500 "						3	8.5	10	7.5	FKP3D011502B00_____
2200 "						3	8.5	10	7.5	FKP3D012202B00_____
3300 "						3	8.5	10	7.5	FKP3D013302B00_____
4700 "						3	8.5	10	7.5	FKP3D014702B00_____
6800 "						4	9	10	7.5	FKP3D016802C00_____
0.01 µF						4	9	10	7.5	FKP3D021002C00_____
0.015 "	4	9	10	7.5	FKP3C021502C00_____	4	9.5	13	10	FKP3D021503D00_____
0.022 "	4	9.5	13	10	FKP3C022203D00_____	5	11	13	10	FKP3D022203F00_____
0.033 "	4	9.5	13	10	FKP3C023303D00_____	6	12	13	10	FKP3D023303G00_____
0.047 "	5	11	13	10	FKP3C024703F00_____	5	11	18	15	FKP3D024704B00_____
0.068 "	6	12	13	10	FKP3C026803G00_____	6	12.5	18	15	FKP3D026804C00_____
0.1 µF	6	12.5	18	15	FKP3C031004C00_____	7	14	18	15	FKP3D031004D00_____
0.15 "	8	15	18	15	FKP3C031504F00_____	9	16	18	15	FKP3D031504J00_____
0.22 "	9	16	18	15	FKP3C032204J00_____					

Capacitance	250 VDC/160 VAC*					400 VDC/250 VAC*				
	W	H	L	PCM**	Part number	W	H	L	PCM**	Part number
100 pF	3	8.5	10	7.5	FKP3F001002B00_____	3	8.5	10	7.5	FKP3G001002B00_____
150 "	3	8.5	10	7.5	FKP3F001502B00_____	3	8.5	10	7.5	FKP3G001502B00_____
220 "	3	8.5	10	7.5	FKP3F002202B00_____	3	8.5	10	7.5	FKP3G002202B00_____
330 "	3	8.5	10	7.5	FKP3F003302B00_____	3	8.5	10	7.5	FKP3G003302B00_____
470 "	3	8.5	10	7.5	FKP3F004702B00_____	3	8.5	10	7.5	FKP3G004702B00_____
680 "	3	8.5	10	7.5	FKP3F006802B00_____	3	8.5	10	7.5	FKP3G006802B00_____
1000 pF	3	8.5	10	7.5	FKP3F011002B00_____	3	8.5	10	7.5	FKP3G011002B00_____
1500 "	3	8.5	10	7.5	FKP3F011502B00_____	4	9	10	7.5	FKP3G011502C00_____
2200 "	4	9	10	7.5	FKP3F012202C00_____	4	9	10	7.5	FKP3G012202C00_____
						4	9.5	13	10	FKP3G012203D00_____
3300 "	3	9	13	10	FKP3F013303A00_____	4	9.5	13	10	FKP3G013303D00_____
4700 "	4	9.5	13	10	FKP3F014703D00_____	5	11	13	10	FKP3G014703F00_____
6800 "	5	11	13	10	FKP3F016803F00_____	6	12	13	10	FKP3G016803G00_____
0.01 µF	5	11	13	10	FKP3F021003F00_____	5	11	18	15	FKP3G021004B00_____
0.015 "	6	12	13	10	FKP3F021503G00_____	6	12.5	18	15	FKP3G021504C00_____
0.022 "	5	11	18	15	FKP3F021504B00_____					
0.033 "	6	12.5	18	15	FKP3F022204C00_____	7	14	18	15	FKP3G022204D00_____
0.047 "	7	14	18	15	FKP3F023304D00_____	8	15	18	15	FKP3G023304F00_____
0.068 "	8	15	18	15	FKP3F024704F00_____	9	16	18	15	FKP3G024704J00_____
	9	16	18	15	FKP3F026804J00_____					

* AC voltage: $f \leq 1000 \text{ Hz}$; $1.4 \times U_{\text{rms}} + U_{\text{DC}} \leq U_r$

** PCM = Printed circuit module = pin spacing

Dims. in mm.

Part number completion:

Tolerance: 20 % = M

10 % = K

5 % = J

Packing: bulk = S

Pin length: 6-2 = SD

Taped version see page 145.

Rights reserved to amend design data without prior notification.

Continuation

General Data

Capacitance	630 VDC/300 VAC*					1000 VDC/300 VAC*				
	W	H	L	PCM**	Part number	W	H	L	PCM**	Part number
100 pF	3	8.5	10	7.5	FKP3J001002B00_	3	8.5	10	7.5	FKP3O101002B00_
150 "	3	8.5	10	7.5	FKP3J001502B00_	3	8.5	10	7.5	FKP3O101502B00_
220 "	3	8.5	10	7.5	FKP3J002202B00_	3	8.5	10	7.5	FKP3O102202B00_
330 "	3	8.5	10	7.5	FKP3J003302B00_	3	8.5	10	7.5	FKP3O103302B00_
470 "	3	8.5	10	7.5	FKP3J004702B00_	3	8.5	10	7.5	FKP3O104702B00_
680 "	3	8.5	10	7.5	FKP3J006802B00_	3	8.5	10	7.5	FKP3O106802B00_
1000 pF	4	9	10	7.5	FKP3J011002C00_	4	9	10	7.5	FKP3O111002C00_
1500 "	4	9.5	13	10	FKP3J011503D00_	4	9.5	13	10	FKP3O111503D00_
2200 "	4	9.5	13	10	FKP3J012203D00_	4	9.5	13	10	FKP3O112203D00_
3300 "	5	11	13	10	FKP3J013303F00_	5	11	13	10	FKP3O113303F00_
4700 "	6	12	13	10	FKP3J014703G00_	6	12	13	10	FKP3O114703G00_
6800 "	5	11	18	15	FKP3J016804B00_	5	11	18	15	FKP3O116804B00_
0.01 µF	6	12.5	18	15	FKP3J021004C00_	6	12.5	18	15	FKP3O121004C00_
0.015 "	8	15	18	15	FKP3J021504F00_	8	15	18	15	FKP3O121504F00_
0.022 "	9	16	18	15	FKP3J022204J00_	9	16	18	15	FKP3O122204J00_
0.033 "	9	16	18	15	FKP3J023304J00_	9	16	18	15	FKP3O123304J00_

* AC voltage: $f \leq 1000 \text{ Hz}$; $1.4 \times U_{\text{rms}} + \text{UDC} \leq U_r$

** PCM = Printed circuit module = pin spacing

Dims. in mm.

$d = 0.5 \phi$ if $W = 3$
 $d = 0.6 \phi$ if $W \geq 4$
 $d = 0.8 \phi$ if $\text{PCM} = 15$

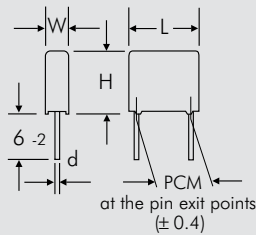

Part number completion:

Tolerance: 20 % = M
 10 % = K
 5 % = J
 Packing: bulk = S
 Pin length: 6-2 = SD
 Taped version see page 145.

Rights reserved to amend design data without prior notification.

Permissible AC voltage in relation to frequency at 10° C internal temperature rise (general guide).

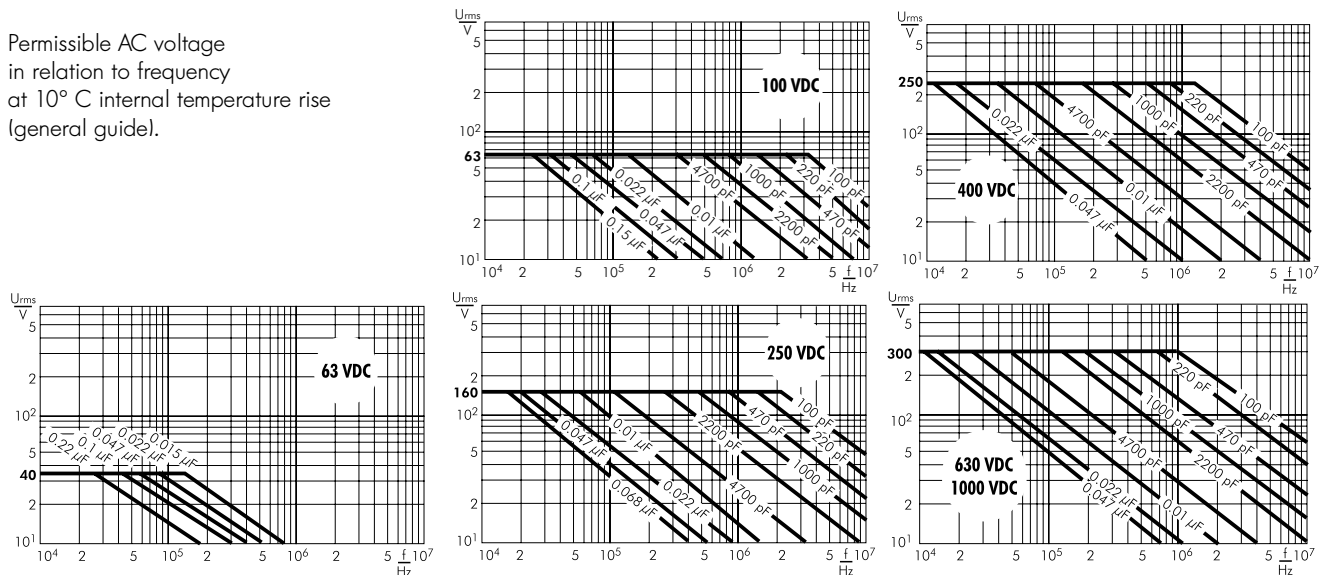

WIMA Capacitors with Metallized, Self-Healing Construction PCM 5 to 52.5 mm

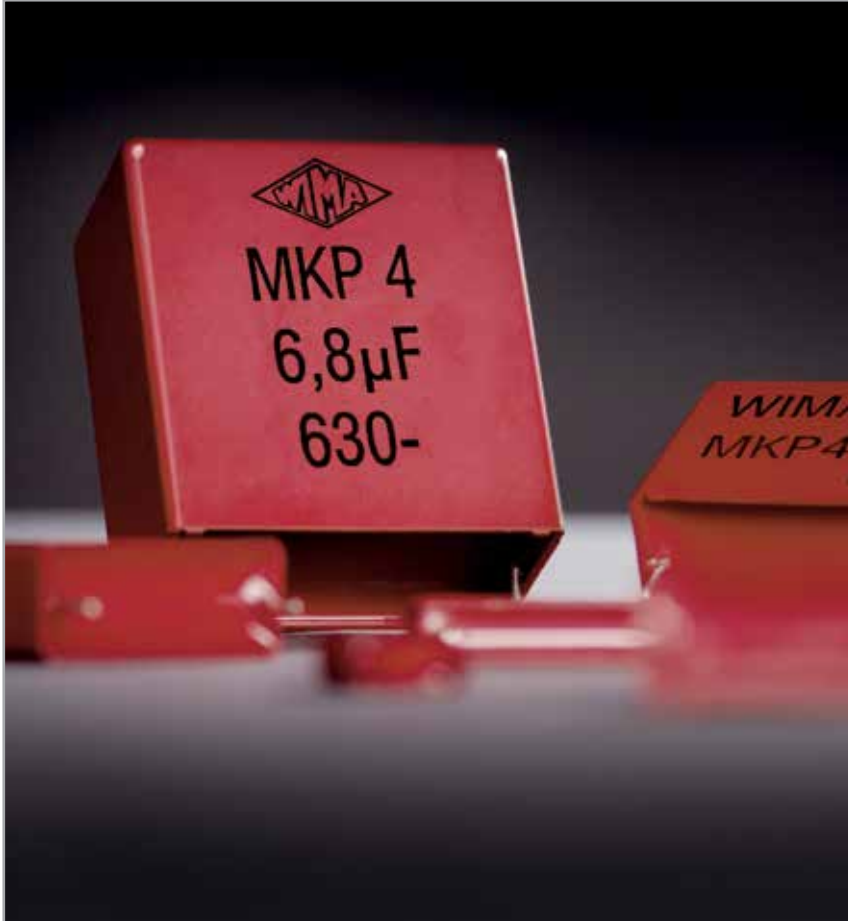

WIMA MKS 2

WIMA MKP 2

WIMA MKS 4

WIMA MKP 4C

WIMA MKP 4

In the case of metallized capacitors, thin layers of aluminium (approx. 0.03 μm) are vacuum-deposited on the insulating film as conducting electrodes. In the case of a breakdown, the short circuit current causes the thin metal coating to evaporate around the point of failure and an insulating area is formed. The capacitor remains intact (self-healing). Due to their construction principle metallized capacitors stand out for their very favourable capacitance/volume ratio.

Metallized WIMA capacitors in PCM 5 mm – 52.5 mm are available in two dielectric versions.

Capacitors with a Polyester dielectric (PET) are suitable for general applications such

as coupling, decoupling and by-passing. By making use of ultra thin film and appropriate manufacturing experience, it has been possible to achieve high capacitance values in very small box sizes. The WIMA MKS 2 for example is available with capacitance values up to 10 μF in PCM 5 mm whereas the MKS 4 is offering capacitances up to 680 μF in PCM 52.5 mm.

Polypropylene capacitors (PP) are used in the high frequency field. This includes resonant circuits, power supplies, deflection circuits, oscillator circuits and audio equipment. WIMA metallized Polypropylene capacitors in PCM 5 - 37.5 mm are available with capacitance values up to 10 μF and voltage ratings up to 1000 VDC.

Upon customer request, larger box sizes can be supplied in 4-pin versions. Types with terminating plates can also be manufactured on request. The advantage of this method of construction, besides the improved mechanical stability of the component on the board, is the excellent electrical contact reliability.

WIMA capacitors are produced with the proven box technology using solvent-resistant, flame-retardant plastic cases according to UL 94 V-0. They are environmentally compatible with the RoHS 2011/65/EU regulations of the European Union.



Metallized Polyester (PET) Capacitors in PCM 5 mm. Capacitances from 0.01 µF to 10 µF. Rated Voltages from 50 VDC to 630 VDC.

Special Features

- High volume/capacitance ratio
- Self-healing
- AEC-Q200 qualified
- According to RoHS 2011/65/EU

Typical Applications

For general DC-applications e.g.

- By-pass
- Blocking
- Coupling and decoupling
- Timing

Construction

Dielectric:

Polyethylene-terephthalate (PET) film

Capacitor electrodes:

Vacuum-deposited

Internal construction:

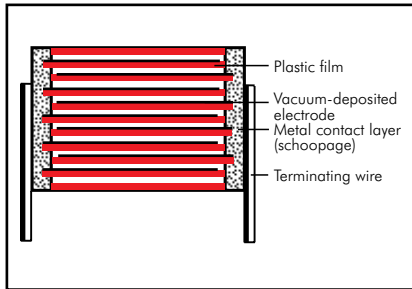

Encapsulation:

Solvent-resistant, flame-retardant plastic case with epoxy resin seal, UL 94 V-0

Terminations:

Tinned wire.

Marking:

Colour: Red. Marking: Silver/White.

Epoxy resin seal: Red

Electrical Data

Capacitance range:

0.01 µF to 10 µF (E12-values on request)

Rated voltages:

50 VDC, 63 VDC, 100 VDC, 250 VDC, 400 VDC, 630 VDC

Capacitance tolerances:

±20%, ±10%, ±5%

Operating temperature range:

$U_r = 50$ VDC: -55° C to +100° C

$U_r \geq 63$ VDC: -55° C to +125° C

Climatic test category:

55/100/21 in accordance with IEC

Insulation resistance at +20° C:

U_r	U_{test}	$C \leq 0.33 \mu F$	$0.33 \mu F < C \leq 10 \mu F$
50 VDC	10V	$\geq 5 \times 10^3 M\Omega$ (mean value: $3 \times 10^4 M\Omega$)	≥ 1000 sec ($M\Omega \times \mu F$) (mean value: 3000 sec)
63 VDC	50V	$\geq 1 \times 10^4 M\Omega$ (mean value: $5 \times 10^4 M\Omega$)	≥ 1250 sec ($M\Omega \times \mu F$) (mean value: 3000 sec)
≥ 100 VDC	100V	$\geq 1.5 \times 10^4 M\Omega$ (mean value: $1 \times 10^5 M\Omega$)	≥ 3000 sec ($M\Omega \times \mu F$) (mean value: 6000 sec)

Measuring time: 1 min.

Dissipation factors at +20° C: $\tan \delta$

at f	$C \leq 0.1 \mu F$	$0.1 \mu F < C \leq 1.0 \mu F$	$C > 1.0 \mu F$
1 kHz	$\leq 8 \times 10^{-3}$	$\leq 8 \times 10^{-3}$	$\leq 10 \times 10^{-3}$
10 kHz	$\leq 15 \times 10^{-3}$	$\leq 15 \times 10^{-3}$	-
100 kHz	$\leq 30 \times 10^{-3}$	-	-

Maximum pulse rise time: for pulses equal to the rated voltage

Capacitance µF	Pulse rise time V/µsec max. operation/test					
	50 VDC	63 VDC	100 VDC	250 VDC	400 VDC	630 VDC
0.01 ... 0.022	-	35/350	35/350	50/500	80/800	110/1100
0.033 ... 0.068	-	20/200	25/250	50/500	80/800	90/900
0.1 ... 0.47	10/100	15/150	20/200	50/500	80/800	-
0.68 ... 1.0	8/80	12/120	15/150	25/250	-	-
1.5 ... 3.3	8/80	7.5/75	10/100	-	-	-
4.7	5/50	5/50	-	-	-	-
6.8	3/30	3/30	-	-	-	-
10	2.5/25	-	-	-	-	-

Mechanical Tests

Pull test on pins:

10 N in direction of pins according to IEC 60068-2-21

Vibration:

6 hours at 10 ... 2000 Hz and 0.75 mm displacement amplitude or 10 g in accordance with IEC 60068-2-6

Low air density:

1kPa = 10 mbar in accordance with IEC 60068-2-13

Bump test:

4000 bumps at 390 m/sec² in accordance with IEC 60068-2-29

Packing

Available taped and reeled.

Detailed taping information and graphs at the end of the catalogue.

For further details and graphs please refer to Technical Information.

Continuation

General Data

Capacitance	50 VDC/30 VAC*					63 VDC/40 VAC*				
	W	H	L	PCM**	Part number	W	H	L	PCM**	Part number
0.01 μ F						2.5	6.5	7.2	5	MKS2C021001A00_____
0.015 "						2.5	6.5	7.2	5	MKS2C021501A00_____
0.022 "						2.5	6.5	7.2	5	MKS2C022201A00_____
0.033 "						2.5	6.5	7.2	5	MKS2C023301A00_____
0.047 "						2.5	6.5	7.2	5	MKS2C024701A00_____
0.068 "						2.5	6.5	7.2	5	MKS2C026801A00_____
0.1 μ F						2.5	6.5	7.2	5	MKS2C031001A00_____
0.15 "						2.5	6.5	7.2	5	MKS2C031501A00_____
0.22 "						3	7.5	7.2	5	MKS2C032201B00_____
0.33 "	2.5	6.5	7.2	5	MKS2B033301A00_____	3.5	8.5	7.2	5	MKS2C033301C00_____
0.47 "	3	7.5	7.2	5	MKS2B034701B00_____	3.5	8.5	7.2	5	MKS2C034701C00_____
0.68 "	3.5	8.5	7.2	5	MKS2B036801C00_____	4.5	9.5	7.2	5	MKS2C036801E00_____
1.0 μ F	3.5	8.5	7.2	5	MKS2B041001C00_____	5	10	7.2	5	MKS2C041001F00_____
1.5 "	4.5	9.5	7.2	5	MKS2B041501E00_____	5.5	11.5	7.2	5	MKS2C041501H00_____
2.2 "	5	10	7.2	5	MKS2B042201F00_____	7.2	13	7.2	5	MKS2C042201K00_____
3.3 "	5.5	11.5	7.2	5	MKS2B043301H00_____	7.2	13	7.2	5	MKS2C043301K00_____
4.7 "	7.2	13	7.2	5	MKS2B044701K00_____	8.5	14	7.2	5	MKS2C044701M00_____
6.8 "	8.5	14	7.2	5	MKS2B046801M00_____	11	16	7.2	5	MKS2C046801N00_____
10 μ F	11	16	7.2	5	MKS2B051001N00_____					

Capacitance	100 VDC/63 VAC*					250 VDC/160 VAC*				
	W	H	L	PCM**	Part number	W	H	L	PCM**	Part number
0.01 μ F	2.5	6.5	7.2	5	MKS2D021001A00_____	2.5	6.5	7.2	5	MKS2F021001A00_____
0.015 "	2.5	6.5	7.2	5	MKS2D021501A00_____	2.5	6.5	7.2	5	MKS2F021501A00_____
0.022 "	2.5	6.5	7.2	5	MKS2D022201A00_____	2.5	6.5	7.2	5	MKS2F022201A00_____
0.033 "	2.5	6.5	7.2	5	MKS2D023301A00_____	3.5	8.5	7.2	5	MKS2F023301C00_____
0.047 "	2.5	6.5	7.2	5	MKS2D024701A00_____	3.5	8.5	7.2	5	MKS2F024701C00_____
0.068 "	2.5	6.5	7.2	5	MKS2D026801A00_____	3.5	8.5	7.2	5	MKS2F026801C00_____
0.1 μ F	2.5	6.5	7.2	5	MKS2D031001A00_____	4.5	9.5	7.2	5	MKS2F031001E00_____
0.15 "	3.5	8.5	7.2	5	MKS2D031501C00_____	5	10	7.2	5	MKS2F031501F00_____
0.22 "	3.5	8.5	7.2	5	MKS2D032201C00_____	5.5	11.5	7.2	5	MKS2F032201H00_____
0.33 "	4.5	9.5	7.2	5	MKS2D033301E00_____	7.2	13	7.2	5	MKS2F033301K00_____
0.47 "	4.5	9.5	7.2	5	MKS2D034701E00_____	8.5	14	7.2	5	MKS2F034701M00_____
0.68 "	5	10	7.2	5	MKS2D036801F00_____	11	16	7.2	5	MKS2F036801N00_____
1.0 μ F	7.2	13	7.2	5	MKS2D041001K00_____					
1.5 "	8.5	14	7.2	5	MKS2D041501M00_____					
2.2 "	11	16	7.2	5	MKS2D042201N00_____					

* AC voltage: $f = 50 \text{ Hz}$; $1.4 \times U_{\text{rms}} + U_{\text{DC}} \leq U_r$

** PCM = Printed circuit module = pin spacing.

Dims. in mm.

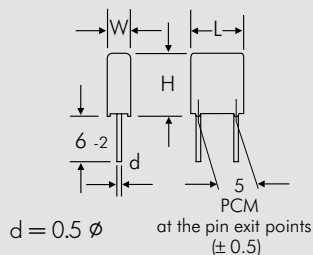

Part number completion:

Tolerance: 20 % = M

10 % = K

5 % = J

Packing: bulk = S

Pin length: 6-2 = SD

Taped version see page 145.

Rights reserved to amend design data without prior notification.

Continuation page 46

Continuation

General Data

Capacitance	400 VDC/200 VAC*					630 VDC/220 VAC*				
	W	H	L	PCM**	Part number	W	H	L	PCM**	Part number
0.01 μF	2.5	6.5	7.2	5	MKS2G021001A00	5.5	11.5	7.2	5	MKS2J021001H00
0.015 "	2.5	6.5	7.2	5	MKS2G021501A00	7.2	13	7.2	5	MKS2J021501K00
0.022 "	3.5	8.5	7.2	5	MKS2G022201C00	7.2	13	7.2	5	MKS2J022201K00
0.033 "	4.5	9.5	7.2	5	MKS2G023301E00	7.2	13	7.2	5	MKS2J023301K00
0.047 "	4.5	9.5	7.2	5	MKS2G024701E00	8.5	14	7.2	5	MKS2J024701M00
0.068 "	5.5	11.5	7.2	5	MKS2G026801H00					
0.1 μF	7.2	13	7.2	5	MKS2G031001K00					
0.15 "	8.5	14	7.2	5	MKS2G031501M00					
0.22 "	11	16	7.2	5	MKS2G032201N00					

* AC voltage: $f = 50 \text{ Hz}$; $1.4 \times U_{\text{rms}} + U_{\text{DC}} \leq U_r$

** PCM = Printed circuit module = pin spacing.

Dims. in mm.

The values of the WIMA MKM 2 range according to the main catalogue 2009 are still available on request.

Part number completion:

Tolerance: 20 % = M

10 % = K

5 % = J

Packing: bulk = S

Pin length: 6-2 = SD

Taped version see page 145.

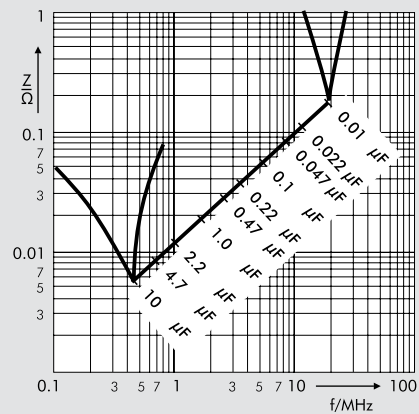

Impedance change with frequency (general guide).

Rights reserved to amend design data without prior notification.

Permissible AC voltage in relation to frequency at 10° C internal temperature rise (general guide).

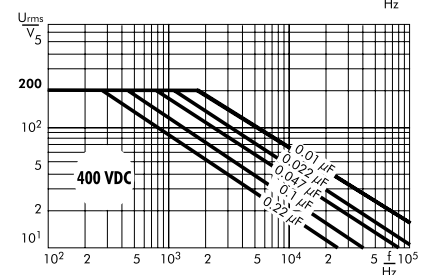
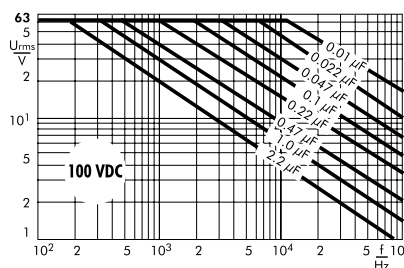
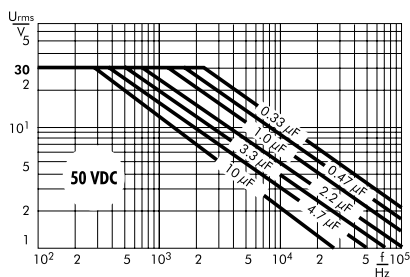
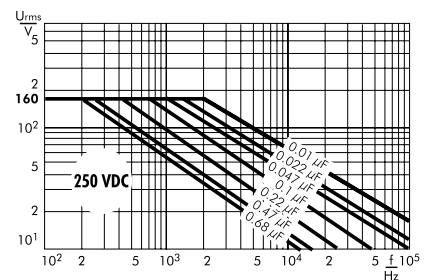
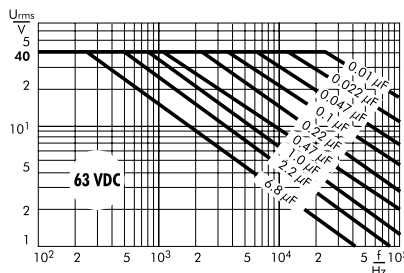

Metallized Polypropylene (PP) Capacitors in PCM 5 mm.
Capacitances from 1000 pF to 1.0 μF. Rated Voltages from 63 VDC to 1000 VDC.

Special Features

- High volume/capacitance ratio
- Self-healing
- Increased pulse duty from 250 VDC rated voltage
- Very low dissipation factor
- Negative capacitance change versus temperature
- Very low dielectric absorption
- AEC-Q200 qualified
- According to RoHS 2011/65/EU

Typical Applications

- For high frequency applications e.g.
- Sample and hold
 - Timing
 - Oscillating circuits
 - High frequency coupling and decoupling

Construction

Dielectric:

Polypropylene (PP) film

Capacitor electrodes:

Vacuum-deposited

Internal construction:

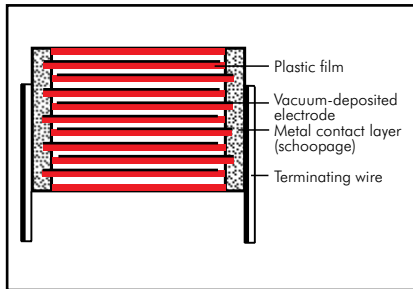

Encapsulation:

Solvent-resistant, flame-retardant plastic case with epoxy resin seal, UL 94 V-0

Terminations:

Tinned wire.

Marking:

Colour: Red. Marking: Black.
 Epoxy resin seal: Red

Electrical Data

Capacitance range:

1000 pF to 1.0 μF (E12-values on request)

Rated voltages:

63 VDC, 100 VDC, 250 VDC, 400 VDC,
 630 VDC, 800 VDC, 1000 VDC

Capacitance tolerances:

± 20%, ±10%, ±5%

Operating temperature range:

-55° C to +100° C

Test specifications:

In accordance with IEC 60384-16

Climatic test category:

55/100/56 in accordance with IEC

Insulation resistance at +20° C:

≥ 3 × 10⁴ MΩ

(mean value: 1 × 10⁵ MΩ)

Measuring voltage:

U_r = 63 V: U_{test} = 50 V/1 min.

U_r ≥ 100 V: U_{test} = 100 V/1 min.

Test voltage:

1.6 U_r, 2 sec.

Maximum pulse rise time:

Capacitance pF/μF	max. pulse rise time V/μsec						
	63 VDC	100 VDC	250 VDC	400 VDC	630 VDC	800 VDC	1000 VDC
1000 ... 2200	-	-	-	300	400	450	500
3300 ... 6800	-	-	-	300	400	450	500
0.01 ... 0.022	100	100	250	300	400	450	500
0.033 ... 0.068	100	100	250	300	400	450	-
0.1 ... 0.22	100	100	250	250	-	-	-
0.33 ... 0.68	100	100	250	-	-	-	-
1.0	70	70	-	-	-	-	-

for pulses equal to the rated voltage

Mechanical Tests

Pull test on pins:

10 N in direction of pins according to IEC 60068-2-21

Vibration:

6 hours at 10 ... 2000 Hz and 0.75 mm displacement amplitude or 10 g in accordance with IEC 60068-2-6

Low air density:

1 kPa = 10 mbar in accordance with IEC 60068-2-13

Bump test:

4000 bumps at 390 m/sec² in accordance with IEC 60068-2-29

Dielectric absorption:

0.05 %

Dissipation factors at +20° C: tan δ

at f	C ≤ 0.1 μF	0.1 μF < C ≤ 1.0 μF
1 kHz	≤ 0.5 × 10 ⁻³	≤ 0.5 × 10 ⁻³
10 kHz	≤ 0.8 × 10 ⁻³	≤ 0.8 × 10 ⁻³
100 kHz	≤ 3.0 × 10 ⁻³	-

Voltage derating:

A voltage derating factor of 1.35 % per K must be applied from +85° C for DC voltages and from +75° C for AC voltages

Reliability:

Operational life > 300 000 hours

Failure rate < 2 fit (0.5 × U_r and 40° C)

Packing

Available taped and reeled.

Detailed taping information and graphs at the end of the catalogue.

For further details and graphs please refer to Technical Information.

Continuation

General Data

Capacitance	63 VDC/40 VAC*					100 VDC/63 VAC*				
	W	H	L	PCM**	Part number	W	H	L	PCM**	Part number
0.01 μ F	3	7.5	7.2	5	MKP2C021001B00_	3	7.5	7.2	5	MKP2D021001B00_
0.015 "	3	7.5	7.2	5	MKP2C021501B00_	3	7.5	7.2	5	MKP2D021501B00_
0.022 "	3	7.5	7.2	5	MKP2C022201B00_	3	7.5	7.2	5	MKP2D022201B00_
0.033 "	3	7.5	7.2	5	MKP2C023301B00_	3	7.5	7.2	5	MKP2D023301B00_
0.047 "	3.5	8.5	7.2	5	MKP2C024701C00_	3.5	8.5	7.2	5	MKP2D024701C00_
0.068 "	4.5	9.5	7.2	5	MKP2C026801E00_	4.5	9.5	7.2	5	MKP2D026801E00_
0.1 μ F	5	10	7.2	5	MKP2C031001F00_	5	10	7.2	5	MKP2D031001F00_
0.15 "	5.5	11.5	7.2	5	MKP2C031501H00_	5.5	11.5	7.2	5	MKP2D031501H00_
0.22 "	7.2	13	7.2	5	MKP2C032201K00_	7.2	13	7.2	5	MKP2D032201K00_
0.33 "	8.5	14	7.2	5	MKP2C033301M00_	8.5	14	7.2	5	MKP2D033301M00_
0.47 "	8.5	14	7.2	5	MKP2C034701M00_	8.5	14	7.2	5	MKP2D034701M00_
0.68 "	8.5	14	7.2	5	MKP2C036801M00_	8.5	14	7.2	5	MKP2D036801M00_
1.0 μ F	11	16	7.2	5	MKP2C041001N00_	11	16	7.2	5	MKP2D041001N00_

Capacitance	250 VDC/160 VAC*					400 VDC/200 VAC*				
	W	H	L	PCM**	Part number	W	H	L	PCM**	Part number
1000 pF						3	7.5	7.2	5	MKP2G011001B00_
1500 "						3	7.5	7.2	5	MKP2G011501B00_
2200 "						3	7.5	7.2	5	MKP2G012201B00_
3300 "						3	7.5	7.2	5	MKP2G013301B00_
4700 "						3	7.5	7.2	5	MKP2G014701B00_
6800 "						3	7.5	7.2	5	MKP2G016801B00_
0.01 μ F	3	7.5	7.2	5	MKP2F021001B00_	3.5	8.5	7.2	5	MKP2G021001C00_
0.015 "	3	7.5	7.2	5	MKP2F021501B00_	3.5	8.5	7.2	5	MKP2G021501C00_
0.022 "	3	7.5	7.2	5	MKP2F022201B00_	4.5	9.5	7.2	5	MKP2G022201E00_
0.033 "	3	7.5	7.2	5	MKP2F023301B00_	5.5	11.5	7.2	5	MKP2G023301H00_
0.047 "	3.5	8.5	7.2	5	MKP2F024701C00_	7.2	13	7.2	5	MKP2G024701K00_
0.068 "	4.5	9.5	7.2	5	MKP2F026801E00_	7.2	13	7.2	5	MKP2G026801K00_
0.1 μ F	5	10	7.2	5	MKP2F031001F00_	8.5	14	7.2	5	MKP2G031001M00_
0.15 "	7.2	13	7.2	5	MKP2F031501K00_	11	16	7.2	5	MKP2G031501N00_
0.22 "	7.2	13	7.2	5	MKP2F032201K00_					
0.33 "	8.5	14	7.2	5	MKP2F033301M00_					
0.47 "	11	16	7.2	5	MKP2F034701N00_					

Capacitance	630 VDC/250 VAC*				
	W	H	L	PCM**	Part number
1000 pF	3	7.5	7.2	5	MKP2J011001B00_
1500 "	3	7.5	7.2	5	MKP2J011501B00_
2200 "	3	7.5	7.2	5	MKP2J012201B00_
3300 "	3	7.5	7.2	5	MKP2J013301B00_
4700 "	3	7.5	7.2	5	MKP2J014701B00_
6800 "	3.5	8.5	7.2	5	MKP2J016801C00_
0.01 μ F	4.5	9.5	7.2	5	MKP2J021001E00_
0.015 "	5	10	7.2	5	MKP2J021501F00_
0.022 "	5.5	11.5	7.2	5	MKP2J022201H00_
0.033 "	7.2	13	7.2	5	MKP2J023301K00_
0.047 "	8.5	14	7.2	5	MKP2J024701M00_
0.068 "	11	16	7.2	5	MKP2J026801N00_

New values

** PCM = Printed circuit module = pin spacing.

Dims. in mm.

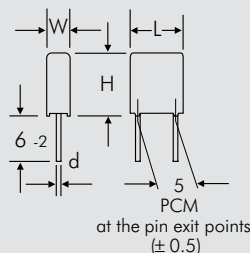

Part number completion:	
Tolerance:	20 % = M
	10 % = K
	5 % = J
Packing:	bulk = S
Pin length:	6-2 = SD
Taped version see page 145.	

* AC voltage: $f \leq 400 \text{ Hz}$; $1.4 \times U_{\text{rms}} + \text{UDC} \leq U_r$

$$d = 0.5 \phi$$

Rights reserved to amend design data without prior notification.

Continuation

General Data

Capacitance	800 VDC/250 VAC*					1000 VDC/250 VAC*				
	W	H	L	PCM**	Part number	W	H	L	PCM**	Part number
1000 pF	3	7.5	7.2	5	MKP2L011001B00_	3	7.5	7.2	5	MKP2O111001B00_
1500 "	3	7.5	7.2	5	MKP2L011501B00_	3	7.5	7.2	5	MKP2O111501B00_
2200 "	3	7.5	7.2	5	MKP2L012201B00_	3	7.5	7.2	5	MKP2O112201B00_
3300 "	3	7.5	7.2	5	MKP2L013301B00_	3.5	8.5	7.2	5	MKP2O113301C00_
4700 "	3.5	8.5	7.2	5	MKP2L014701C00_	4.5	9.5	7.2	5	MKP2O114701E00_
6800 "	4.5	9.5	7.2	5	MKP2L016801E00_	5	10	7.2	5	MKP2O116801F00_
0.01 μF	5	10	7.2	5	MKP2L021001F00_	7.2	13	7.2	5	MKP2O121001K00_
0.015 "	5.5	11.5	7.2	5	MKP2L021501H00_	8.5	14	7.2	5	MKP2O121501M00_
0.022 "	7.2	13	7.2	5	MKP2L022201K00_	11	16	7.2	5	MKP2O122201N00_
0.033 "	8.5	14	7.2	5	MKP2L023301M00_					
0.047 "	11	16	7.2	5	MKP2L024701N00_					

* AC voltage: $f \leq 400 \text{ Hz}$; $1.4 \times U_{\text{rms}} + U_{\text{DC}} \leq U_r$

New range and values

** PCM = printed circuit module = pin spacing.

Dims. in mm.

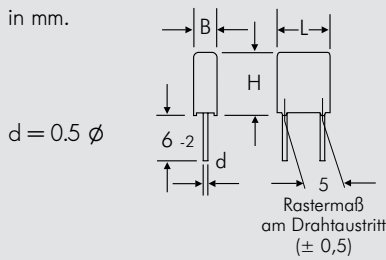

Part number completion:
 Tolerance: 20 % = M
 10 % = K
 5 % = J
 Packing: bulk = S
 Pin length: 6-2 = SD
 Taped version see page 145.

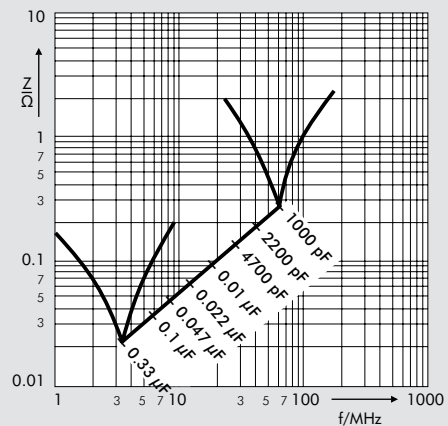

Impedance change with frequency (general guide).

Rights reserved to amend design data without prior notification.

Permissible AC voltage in relation to frequency at 10° C internal temperature rise (general guide).

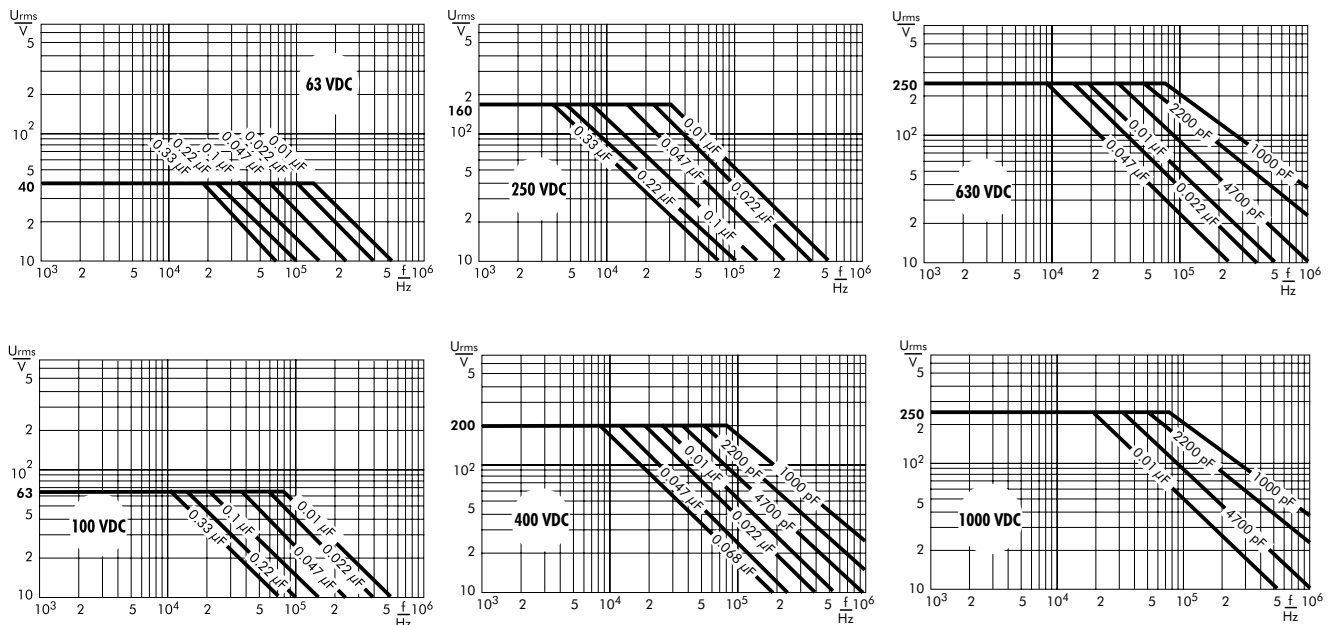

Metallized Polyester (PET) Capacitors in PCM 7.5 mm to 52.5 mm. Capacitances from 1000 pF to 680 µF. Rated Voltages from 50 VDC to 2000 VDC.

Special Features

- High volume/capacitance ratio
- Self-healing
- According to RoHS 2011/65/EU

Typical Applications

For general DC-applications e.g.

- By-pass
- Blocking
- Coupling and decoupling
- Smoothing
- Timing

Construction

Dielectric:

Polyethylene-terephthalate (PET) film

Capacitor electrodes:

Vacuum-deposited

Internal construction:

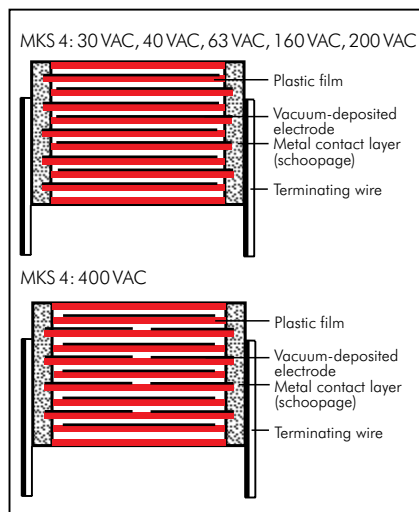

Encapsulation:

Solvent-resistant, flame-retardant plastic case with epoxy resin seal, UL 94 V-0

Terminations:

Tinned wire.

Marking:

Colour: Red. Marking: Black.

Epoxy resin seal: Red

Electrical Data

Capacitance range:

1000 pF to 680 µF (E12-values on request)

Rated voltages:

50 VDC, 63 VDC, 100 VDC, 250 VDC, 400 VDC, 630 VDC, 1000 VDC, 1500 VDC, 2000 VDC

Capacitance tolerances:

±20%, ±10% ±5%

Operating temperature range:

$U_r = 50$ VDC: -55° C to +100° C

$U_r \geq 63$ VDC: -55° C to +125° C

Climatic test category:

55/100/56 in accordance with IEC

Insulation resistance at +20° C:

U_r	U_{test}	$C \leq 0.33 \mu F$	$0.33 \mu F < C \leq 680 \mu F$
50 VDC	10V	$\geq 5 \times 10^3 M\Omega$ (mean value: $3 \times 10^4 M\Omega$)	≥ 1500 sec ($IM\Omega \times \mu F$) (mean value: 4500 sec)
63 VDC	50V	$\geq 1 \times 10^4 M\Omega$ (mean value: $5 \times 10^4 M\Omega$)	≥ 3000 sec ($IM\Omega \times \mu F$) (mean value: 6000 sec)
100 VDC	100V	$\geq 1.5 \times 10^4 M\Omega$ (mean value: $5 \times 10^4 M\Omega$)	≥ 5000 sec ($IM\Omega \times \mu F$) (mean value: 15000 sec)
≥ 250 VDC	100V	$\geq 3 \times 10^4 M\Omega$ (mean value: $1 \times 10^5 M\Omega$)	≥ 10000 sec ($IM\Omega \times \mu F$) (mean value: 40000 sec)

Test voltage: 1.6 U_r , 2 sec.

Test specifications:

In accordance with IEC 60384-2

Voltage derating:

A voltage derating factor of 1.25 % per K must be applied from +85° C for DC voltages and from +75° C for AC voltages.

Reliability:

Operational life > 300 000 hours (+125° C permitted for 1000 hours max. distributed over the entire operating life)

Failure rate < 2 fit ($10.5 \times U_r$ and 40° C)

Measuring time: 1 min.

Dissipation factors at + 20° C: $\tan \delta$

at f	$C \leq 0.1 \mu F$	$0.1 \mu F < C \leq 1.0 \mu F$	$C > 1.0 \mu F$
1 kHz	$\leq 8 \times 10^{-3}$	$\leq 8 \times 10^{-3}$	$\leq 10 \times 10^{-3}$
10 kHz	$\leq 15 \times 10^{-3}$	$\leq 15 \times 10^{-3}$	-
100 kHz	$\leq 30 \times 10^{-3}$	-	-

Maximum pulse rise time: for pulses equal to the rated voltage

Capacitance pF/µF	Pulse rise time V/µsec max. operation/test								
	50VDC	63VDC	100VDC	250VDC	400VDC	630VDC	1000VDC	1500VDC	2000VDC
1000 ... 6800	-	-	-	-	-	-	70/700	90/900	100/1000
0.01 ... 0.022	-	30/300	30/300	35/350	38/380	40/400	50/500	50/500	60/600
0.033 ... 0.068	-	15/150	15/150	20/200	25/250	32/320	26/260	35/350	40/400
0.1 ... 0.22	10/100	10/100	12/120	15/150	15/150	17/170	20/200	35/350	40/400
0.33 ... 0.68	9/90	9/90	9/90	10/100	10/100	13/130	20/200	20/200	38/380
1.0 ... 2.2	6/60	6/60	5/50	6/60	9/90	13/130	14/140	15/150	15/150
3.3 ... 6.8	2.5/25	3/30	3/30	6/60	6/60	9/90	12/120	-	-
10 ... 22	2.5/25	2.5/25	2.5/25	3/30	6/60	6/60	6/60	-	-
33 ... 68	2.5/25	2.5/25	2.5/25	3/30	3/30	3/30	-	-	-
100 ... 220	2.5/25	2.5/25	2.5/25	0.9/9	-	-	-	-	-
330 ... 680	0.2/2	0.2/2	0.3/3	-	-	-	-	-	-

Mechanical Tests

Pull test on pins:

$d \leq 0.8 \phi$: 10 N in direction of pins

$d > 0.8 \phi$: 20 N in direction of pins

according to IEC 60068-2-21

Vibration: 6 hours at 10 ... 2000 Hz and

0.75 mm displacement amplitude or 10 g

in accordance with IEC 60068-2-6

Low air density: 1kPa = 10 mbar in

accordance with IEC 60068-2-13

Bump test: 4000 bumps at 390 m/sec²

in accordance with IEC 60068-2-29

Packing

Available taped and reeled up to and including case size 15 x 26 x 31.5 / PCM 27.5 mm.

Detailed taping information and graphs at the end of the catalogue.

For further details and graphs please refer to Technical Information.

Continuation

General Data

Capacitance	50 VDC/30 VAC*					63 VDC/40 VAC*				
	W	H	L	PCM**	Part number	W	H	L	PCM**	Part number
0.01 μ F						2.5	7	10	7.5	MKS4C021002A
0.015 "						4	9	13	10	MKS4C021003C
0.022 "						2.5	7	10	7.5	MKS4C021502A
0.033 "						4	9	13	10	MKS4C021503C
0.047 "						2.5	7	10	7.5	MKS4C022202A
0.068 "						4	9	13	10	MKS4C022203C
						2.5	7	10	7.5	MKS4C023302A
						4	9	13	10	MKS4C023303C
						2.5	7	10	7.5	MKS4C024702A
						4	9	13	10	MKS4C024703C
						2.5	7	10	7.5	MKS4C026802A
						4	9	13	10	MKS4C026803C
0.1 μ F	2.5	7	10	7.5	MKS4B031002A	2.5	7	10	7.5	MKS4C031002A
0.15 "	2.5	7	10	7.5	MKS4B031502A	4	9	13	10	MKS4C031003C
0.22 "	2.5	7	10	7.5	MKS4B032202A	2.5	7	10	7.5	MKS4C031502A
0.33 "	2.5	7	10	7.5	MKS4B033302A	4	9	13	10	MKS4C031503C
0.47 "	3	8.5	10	7.5	MKS4B034702B	3	8.5	10	7.5	MKS4C032202B
0.68 "	4	9	10	7.5	MKS4B036802C	4	9	13	10	MKS4C032203C
						4	9	10	7.5	MKS4C033302C
						4	9	13	10	MKS4C033303C
						4	9	10	7.5	MKS4C034702C
						4	9	13	10	MKS4C034703C
						5	10.5	10.3	7.5	MKS4C036802E
						4	9	13	10	MKS4C036803C
1.0 μ F	4	9	10	7.5	MKS4B041002C	5	10.5	10.3	7.5	MKS4C041002E
1.5 "	5	10.5	10.3	7.5	MKS4B041502E	4	9	13	10	MKS4C041003C
2.2 "	5.7	12.5	10.3	7.5	MKS4B042202F	5.7	12.5	10.3	7.5	MKS4C041502F
3.3 "	5.7	12.5	10.3	7.5	MKS4B043302F	5	11	13	10	MKS4C041503F
4.7 "	7.2	12.5	10.3	7.5	MKS4B044702G	5	11	13	10	MKS4C042203F
6.8 "	6	12	13	10	MKS4B044703G	6	12.5	18	15	MKS4C042204C
	7.2	12.5	10.3	7.5	MKS4B046802G	6	12	13	10	MKS4C043303G
	6	12	13	10	MKS4B046803G	7	14	18	15	MKS4C043304D
						7	14	18	15	MKS4C044704D
						6	15	26.5	22.5	MKS4C044705B
						8	15	18	15	MKS4C046804F
						7	16.5	26.5	22.5	MKS4C046805D
10 μ F	9	16	18	15	MKS4B051004J	8.5	18.5	26.5	22.5	MKS4C051005F
15 "	11	21	26.5	22.5	MKS4B051505I	11	21	31.5	27.5	MKS4C051006B
22 "	11	21	31.5	27.5	MKS4B052206B	11	21	26.5	22.5	MKS4C051505I
33 "	13	24	31.5	27.5	MKS4B053306D	11	21	31.5	27.5	MKS4C051506B
47 "	15	26	31.5	27.5	MKS4B054706F	13	24	31.5	27.5	MKS4C052206D
68 "	13	24	41.5	37.5	MKS4B054707C	15	26	31.5	27.5	MKS4C053306F
	20	39.5	31.5	27.5	MKS4B056806J	17	29	31.5	27.5	MKS4C054706G
	17	29	41.5	37.5	MKS4B056807E	17	29	41.5	37.5	MKS4C054707E
						20	39.5	31.5	27.5	MKS4C056806J
						19	32	41.5	37.5	MKS4C056807F
100 μ F	19	32	41.5	37.5	MKS4B061007F	20	39.5	41.5	37.5	MKS4C061007G
150 "	20	39.5	41.5	37.5	MKS4B061507G	24	45.5	41.5	37.5	MKS4C061507H
220 "	24	45.5	41.5	37.5	MKS4B062207H	40	55	41.5	37.5	MKS4C062207K
330 "	40	55	41.5	37.5	MKS4B063307K	45	55	57	52.5	MKS4C063309H
470 "	35	50	57	52.5	MKS4B064709F	45	55	57	52.5	MKS4C064709H
680 "	45	55	57	52.5	MKS4B066809H	45	65	57	52.5	MKS4C066809J

* AC voltages: $f = 50 \text{ Hz}$; $1.4 \times U_{\text{rms}} + U_{\text{DC}} \leq U_r$

 New values

** PCM = printed circuit module = pin spacing

Dims. in mm.

Rights reserved to amend design data without prior notification.



Continuation

General Data

Capacitance	100 VDC/63 VAC*					250 VDC/160 VAC*				
	W	H	L	PCM**	Part number	W	H	L	PCM**	Part number
0.01 µF	2.5	7	10	7.5	MKS4D021002A	3	8.5	10	7.5	MKS4F021002B
	4	9	13	10	MKS4D021003C	4	9	13	10	MKS4F021003C
0.015 "	2.5	7	10	7.5	MKS4D021502A	3	8.5	10	7.5	MKS4F021502B
	4	9	13	10	MKS4D021503C	4	9	13	10	MKS4F021503C
0.022 "	2.5	7	10	7.5	MKS4D022202A	3	8.5	10	7.5	MKS4F022202B
	4	9	13	10	MKS4D022203C	4	9	13	10	MKS4F022203C
0.033 "	2.5	7	10	7.5	MKS4D023302A	3	8.5	10	7.5	MKS4F023302B
	4	9	13	10	MKS4D023303C	4	9	13	10	MKS4F023303C
0.047 "	2.5	7	10	7.5	MKS4D024702A	3	8.5	10	7.5	MKS4F024702B
	4	9	13	10	MKS4D024703C	4	9	13	10	MKS4F024703C
0.068 "	2.5	7	10	7.5	MKS4D026802A	4	9	10	7.5	MKS4F026802C
	4	9	13	10	MKS4D026803C	4	9	13	10	MKS4F026803C
0.1 µF	2.5	7	10	7.5	MKS4D031002A	4	9	10	7.5	MKS4F031002C
	4	9	13	10	MKS4D031003C	4	9	13	10	MKS4F031003C
0.15 "	3	8.5	10	7.5	MKS4D031502B	5	10.5	10.3	7.5	MKS4F031502E
	4	9	13	10	MKS4D031503C	4	9	13	10	MKS4F031503C
0.22 "	3	8.5	10	7.5	MKS4D032202B	5	10.5	10.3	7.5	MKS4F032202E
	4	9	13	10	MKS4D032203C	5	11	13	10	MKS4F032203F
0.33 "	4	9	10	7.5	MKS4D033302C	5.7	12.5	10.3	7.5	MKS4F033302F
	4	9	13	10	MKS4D033303C	5	11	13	10	MKS4F033303F
0.47 "	4.5	9.5	10.3	7.5	MKS4D034702D	6	12	13	10	MKS4F034703G
	4	9	13	10	MKS4D034703C	6	12.5	18	15	MKS4F034704C
0.68 "	5	10.5	10.3	7.5	MKS4D036802E	7	14	18	15	MKS4F036804D
	4	9	13	10	MKS4D036803C					
1.0 µF	5.7	12.5	10.3	7.5	MKS4D041002F	8	15	18	15	MKS4F041004F
	5	11	13	10	MKS4D041003F	6	15	26.5	22.5	MKS4F041005B
1.5 "	6	12	13	10	MKS4D041503G	9	16	18	15	MKS4F041504J
	7	14	18	15	MKS4D041504D	7	16.5	26.5	22.5	MKS4F041505D
2.2 "	8	15	18	15	MKS4D042204F	10.5	19	26.5	22.5	MKS4F042205G
	6	15	26.5	22.5	MKS4D042205B	9	19	31.5	27.5	MKS4F042206A
3.3 "	9	16	18	15	MKS4D043304J	11	21	26.5	22.5	MKS4F043305I
	7	16.5	26.5	22.5	MKS4D043305D	11	21	31.5	27.5	MKS4F043306B
4.7 "	10.5	19	26.5	22.5	MKS4D044705G	11	21	31.5	27.5	MKS4F044706B
	9	19	31.5	27.5	MKS4D044706A					
6.8 "	10.5	19	26.5	22.5	MKS4D046805G	13	24	31.5	27.5	MKS4F046806D
	11	21	31.5	27.5	MKS4D046806B					
10 µF	13	24	31.5	27.5	MKS4D051006D	17	29	31.5	27.5	MKS4F051006G
	13	24	31.5	27.5	MKS4D051506D	17	34.5	31.5	27.5	MKS4F051506I
22 "	15	26	31.5	27.5	MKS4D052206F	17	29	41.5	37.5	MKS4F051507E
	17	29	31.5	27.5	MKS4D053306G	19	32	41.5	37.5	MKS4F052207F
33 "	13	24	41.5	37.5	MKS4D053307C	24	45.5	41.5	37.5	MKS4F053307H
	17	29	41.5	37.5	MKS4D054707E					
47 "	17	29	41.5	37.5	MKS4D054707E	31	46	41.5	37.5	MKS4F054707I
	20	39.5	41.5	37.5	MKS4D056807G	40	55	41.5	37.5	MKS4F056807K
100 µF	24	45.5	41.5	37.5	MKS4D061007H	45	65	57	52.5	MKS4F061009J
	31	46	41.5	37.5	MKS4D061507I	45	65	57	52.5	MKS4F061509J
150 "										
220 "										
330 "										
470 "										

* AC voltages: $f = 50 \text{ Hz}$; $1.4 \times U_{\text{rms}} + U_{\text{DC}} \leq U_r$

■ New values

**PCM = printed circuit module = pin spacing

Dims. in mm.

Rights reserved to amend design data without prior notification.

Part number completion:	
Version code:	2-pin = 00 4-pin = D4
Tolerance:	20 % = M 10 % = K 5 % = J
Packing:	bulk = S
Pin length:	6-2 = SD
Taped version see page 145.	

Continuation page 53

Continuation

General Data

Capacitance	400 VDC/200 VAC*					630 VDC/400 VAC*				
	W	H	L	PCM**	Part number	W	H	L	PCM**	Part number
0.01 μ F	3	8.5	10	7.5	MKS4G021002B	3	8.5	10	7.5*	MKS4J021002B
	4	9	13	10	MKS4G021003C	4	9	13	10	MKS4J021003C
0.015 "	3	8.5	10	7.5	MKS4G021502B	4	9	10	7.5*	MKS4J021502C
	4	9	13	10	MKS4G021503C	4	9	13	10	MKS4J021503C
0.022 "	4	9	10	7.5	MKS4G022202C	4.5	9.5	10.3	7.5*	MKS4J022202D
	4	9	13	10	MKS4G022203C	4	9	13	10	MKS4J022203C
0.033 "	4	9	10	7.5	MKS4G023302C	5	10.5	10.3	7.5*	MKS4J023302E
	4	9	13	10	MKS4G023303C	5	11	13	10	MKS4J023303F
0.047 "	5	10.5	10.3	7.5	MKS4G024702E	5.7	12.5	10.3	7.5*	MKS4J024702F
	4	9	13	10	MKS4G024703C	6	12	13	10	MKS4J024703G
0.068 "	5	10.5	10.3	7.5	MKS4G026802E	6	12	13	10	MKS4J026803G
	4	9	13	10	MKS4G026803C	5	11	18	15	MKS4J026804B
0.1 μ F	5	10.5	10.3	7.5	MKS4G031002E	6	12.5	18	15	MKS4J031004C
	5	11	13	10	MKS4G031003F	6	15	26.5	22.5	MKS4J031005B
0.15 "	5.7	12.5	10.3	7.5	MKS4G031502F	7	14	18	15	MKS4J031504D
	6	12	13	10	MKS4G031503G	6	15	26.5	22.5	MKS4J031505B
0.22 "	6	12	13	10	MKS4G032203G	8	15	18	15	MKS4J032204F
	6	12.5	18	15	MKS4G032204C	6	15	26.5	22.5	MKS4J032205B
0.33 "	8	15	18	15	MKS4G033304F	7	16.5	26.5	22.5	MKS4J033305D
						9	19	31.5	27.5	MKS4J033306A
0.47 "	8	15	18	15	MKS4G034704F	10.5	19	26.5	22.5	MKS4J034705G
	6	15	26.5	22.5	MKS4G034705B	9	19	31.5	27.5	MKS4J034706A
0.68 "	7	16.5	26.5	22.5	MKS4G036805D	11	21	26.5	22.5	MKS4J036805I
						11	21	31.5	27.5	MKS4J036806B
1.0 μ F	10.5	19	26.5	22.5	MKS4G041005G	11	21	31.5	27.5	MKS4J041006B
	11	21	31.5	27.5	MKS4G041006B					
1.5 "	11	21	26.5	22.5	MKS4G041505I	15	26	31.5	27.5	MKS4J041506F
	11	21	31.5	27.5	MKS4G041506B					
2.2 "	11	21	31.5	27.5	MKS4G042206B	17	34.5	31.5	27.5	MKS4J042206I
						15	26	41.5	37.5	MKS4J042207D
3.3 "	13	24	31.5	27.5	MKS4G043306D	20	39.5	31.5	27.5	MKS4J043306J
						19	32	41.5	37.5	MKS4J043307F
4.7 "	17	29	31.5	27.5	MKS4G044706G	20	39.5	41.5	37.5	MKS4J044707G
6.8 "	17	34.5	31.5	27.5	MKS4G046806I	24	45.5	41.5	37.5	MKS4J046807H
	15	26	41.5	37.5	MKS4G046807D					
10 μ F	19	32	41.5	37.5	MKS4G051007F	35	50	41.5	37.5	MKS4J051007J
15 "	20	39.5	41.5	37.5	MKS4G051507G	40	55	41.5	37.5	MKS4J051507K
22 "	31	46	41.5	37.5	MKS4G052207I	45	55	57	52.5	MKS4J052209H
33 "	35	50	41.5	37.5	MKS4G053307J					
47 "	35	50	57	52.5	MKS4G054709F					
68 "	45	65	57	52.5	MKS4G056809J					

* AC voltages: $f = 50 \text{ Hz}$; $1.4 \times U_{\text{rms}} + U_{\text{DC}} \leq U_r$

 New values

**PCM = printed circuit module = pin spacing

* Admissible AC voltage 250 VAC max.

Dims. in mm.

Part number completion:

Version code: 2-pin = 00

4-pin = D4

Tolerance: 20 % = M

10 % = K

5 % = J

Packing: bulk = S

Pin length: 6-2 = SD

Taped version see page 145.

Rights reserved to amend design data without prior notification.

Continuation page 54

Continuation

General Data

Capacitance	1000 VDC/400 VAC*					1500 VDC/400 VAC*				
	W	H	L	PCM**	Part number	W	H	L	PCM**	Part number
1000 pF	3	8.5	10	7.5	MKS4O111002B	4	9	13	10	MKS4S011003C
	4	9	13	10	MKS4O111003C					
1500 "	3	8.5	10	7.5	MKS4O111502B	4	9	13	10	MKS4S011503C
	4	9	13	10	MKS4O111503C					
2200 "	3	8.5	10	7.5	MKS4O112202B	4	9	13	10	MKS4S012203C
	4	9	13	10	MKS4O112203C					
3300 "	4	9	10	7.5	MKS4O113302C	4	9	13	10	MKS4S013303C
	4	9	13	10	MKS4O113303C					
4700 "	4	9	10	7.5	MKS4O114702C	4	9	13	10	MKS4S014703C
	4	9	13	10	MKS4O114703C					
6800 "	4.5	9.5	10.3	7.5	MKS4O116802D	5	11	13	10	MKS4S016803F
	4	9	13	10	MKS4O116803C					
0.01 µF	5	10.5	10.3	7.5	MKS4O121002E	6	12	13	10	MKS4S021003G
	5	11	13	10	MKS4O121003F					
0.015 "	5.7	12.5	10.3	7.5	MKS4O121502F	6	12.5	18	15	MKS4S021504C
	6	12	13	10	MKS4O121503G					
0.022 "	5	11	18	15	MKS4O122204B	7	14	18	15	MKS4S022204D
0.033 "	6	12.5	18	15	MKS4O123304C	8	15	18	15	MKS4S023304F
	6	15	26.5	22.5	MKS4O123305B					
0.047 "	7	14	18	15	MKS4O124704D	7	16.5	26.5	22.5	MKS4S024705D
	6	15	26.5	22.5	MKS4O124705B					
0.068 "	8	15	18	15	MKS4O126804F	8.5	18.5	26.5	22.5	MKS4S026805F
	6	15	26.5	22.5	MKS4O126805B					
0.1 µF	9	16	18	15	MKS4O131004J	10.5	19	26.5	22.5	MKS4S031005G
	7	16.5	26.5	22.5	MKS4O131005D					
0.15 "	8.5	18.5	26.5	22.5	MKS4O131505F	11	21	31.5	27.5	MKS4S031506B
0.22 "	10.5	19	26.5	22.5	MKS4O132205G	13	24	31.5	27.5	MKS4S032206D
0.33 "	11	21	26.5	22.5	MKS4O133305I	17	34.5	31.5	27.5	MKS4S033306I
	11	21	31.5	27.5	MKS4O133306B					
0.47 "	13	24	31.5	27.5	MKS4O134706D	20	39.5	31.5	27.5	MKS4S034706J
0.68 "	15	26	31.5	27.5	MKS4O136806F	20	39.5	41.5	37.5	MKS4S036807G
1.0 µF	17	29	31.5	27.5	MKS4O141006G	24	45.5	41.5	37.5	MKS4S041007H
	17	29	41.5	37.5	MKS4O141007E					
1.5 "	19	32	41.5	37.5	MKS4O141507F	31	46	41.5	37.5	MKS4S041507I
2.2 "	20	39.5	41.5	37.5	MKS4O142207G	35	50	41.5	37.5	MKS4S042207J
						35	50	57	52.5	MKS4S042209F
3.3 "	24	45.5	41.5	37.5	MKS4O143307H	45	55	57	52.5	MKS4S043309H
4.7 "	35	50	41.5	37.5	MKS4O144707J	45	65	57	52.5	MKS4S044709J
6.8 "	40	55	41.5	37.5	MKS4O146807K					
	35	50	57	52.5	MKS4O146809F					
10 µF	45	55	57	52.5	MKS4O151009H					

* AC voltages: $f = 50 \text{ Hz}$; $1.4 \times U_{\text{rms}} + U_{\text{DC}} \leq U_r$

■ New values

** PCM = printed circuit module = pin spacing

Dims. in mm.

Rights reserved to amend design data without prior notification.

Part number completion:

Version code: 2-pin = 00

4-pin = D4

Tolerance: 20 % = M

10 % = K

5 % = J

Packing: bulk = S

Pin length: 6-2 = SD

Taped version see page 145.

Continuation page 55

Continuation

General Data

Capacitance	2000 VDC/400 VAC*				
	W	H	L	PCM**	Part number
1000 pF	4	9	13	10	MKS4U011003C
1500 "	4	9	13	10	MKS4U011503C
2200 "	5	11	13	10	MKS4U012203F
3300 "	6	12	13	10	MKS4U013303H
	5	11	18	15	MKS4U013304B
4700 "	5	11	18	15	MKS4U014704B
6800 "	6	12.5	18	15	MKS4U016804C
0.01 μF	7	14	18	15	MKS4U021004D
	6	15	26.5	22.5	MKS4U021005B
0.015 "	6	15	26.5	22.5	MKS4U021505B
0.022 "	7	16.5	26.5	22.5	MKS4U022205D
0.033 "	10.5	19	26.5	22.5	MKS4U023305G
0.047 "	11	21	26.5	22.5	MKS4U024705I
	11	21	31.5	27.5	MKS4U024706B
0.068 "	11	21	31.5	27.5	MKS4U026806B
0.1 μF	13	24	31.5	27.5	MKS4U031006D
0.15 "	17	29	31.5	27.5	MKS4U031506G
	13	24	41.5	37.5	MKS4U031507C
0.22 "	17	29	41.5	37.5	MKS4U032207E
0.33 "	20	39.5	41.5	37.5	MKS4U033307G
0.47 "	24	45.5	41.5	37.5	MKS4U034707H
0.68 "	31	46	41.5	37.5	MKS4U036807I
1.0 μF	40	55	41.5	37.5	MKS4U041007K
	35	50	57	52.5	MKS4U041009F
1.5 "	45	55	57	52.5	MKS4U041509H
2.2 "	45	65	57	52.5	MKS4U042209J

* AC voltage: $f = 50 \text{ Hz}; 1.4 \times U_{\text{rms}} + \text{UDC} \leq U_r$

■ New values

** PCM = Printed circuit module = pin spacing

Dims. in mm.

The values of the WIMA MKM 4 ranges according to the main catalogue 2009 are still available on request.

Part number completion:	
Version code:	2-pin = 00 4-pin = D4
Tolerance:	20 % = M 10 % = K 5 % = J
Packing:	bulk = S
Pin length:	6-2 = SD
Taped version see page 145.	

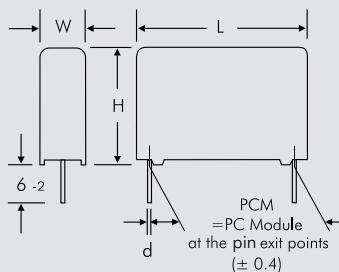

∅ d	PCM	W
0.5	7.5	≤ 3
0.6	7.5	≥ 4
0.6	10	
0.8	15 - 27.5	
1.0	37.5	

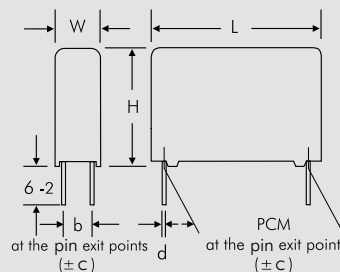

W	PCM	b	∅ d	c
17	37.5	10	1.0	0.4
19	37.5	10	1.0	0.4
20	37.5	12.5	1.0	0.4
24	37.5	12.5	1.0	0.4
31	37.5	20	1.0	0.4
35	37.5	20	1.0	0.4
40	37.5	20	1.0	0.4
35	52.5	20	1.2	0.8
45	52.5	20	1.2	0.8

Rights reserved to amend design data without prior notification.

Permissible AC voltage in relation to frequency at 10° C internal temperature rise (general guide).

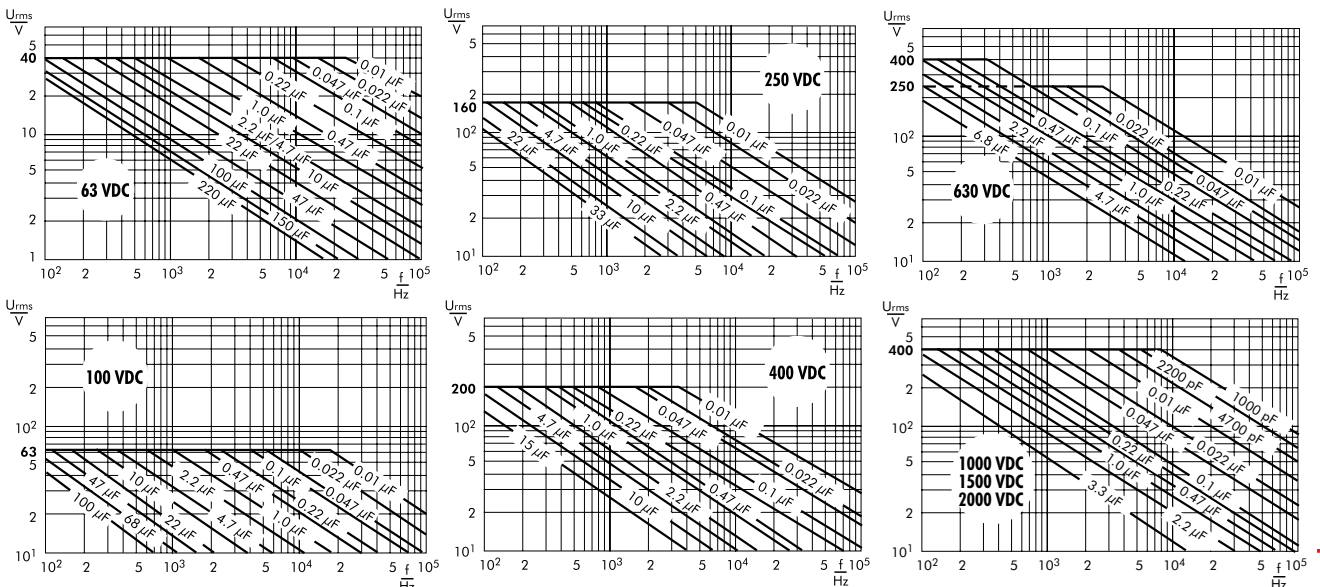

**Compact Type: Metallized Polypropylene (PP)- Capacitors
in PCM 10 mm to 22.5 mm. Capacitances from 0.068 μF to 2.2 μF .
Rated Voltages from 450 VDC to 630 VDC.**

Special Features

- Very compact size, high volume/capacitance ratio
- Self-healing
- Very high ripple and peak current
- High frequency AC operation capability
- High voltage capability
- According to RoHS 2011/65/EU

Typical Applications

- For high frequency applications e.g.
- PFC (power factor correction)

Construction

Dielectric:

Polypropylene (PP) film

Capacitor electrodes:

Vacuum-deposited

Internal construction:

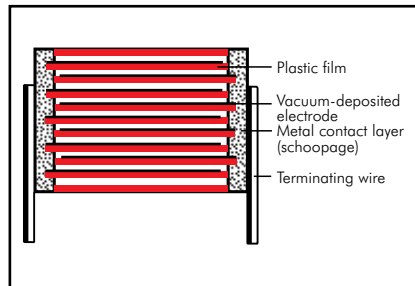

Encapsulation:

Solvent-resistant, flame-retardant plastic case with epoxy resin seal, UL 94 V-0

Terminations:

Tinned wire.

Marking:

Colour: Red. Marking: Black.

Epoxy resin seal: Red

Electrical Data

Capacitance range:

0.068 μF to 2.2 μF (E12-values on request)

Rated voltages:

450 VDC, 520 VDC, 630 VDC

Capacitance tolerances:

$\pm 20\%$, $\pm 10\%$, $\pm 5\%$

Operating temperature range:

-55°C to $+110^\circ\text{C}$

Climatic test category:

55/110/56 in accordance with IEC

Insulation resistance at $+20^\circ\text{C}$:

$C \leq 0.33 \mu\text{F}$: $\geq 1 \times 10^5 \text{ M}\Omega$

(mean value: $5 \times 10^5 \text{ M}\Omega$)

$C > 0.33 \mu\text{F}$: $\geq 30\,000 \text{ sec (M}\Omega \times \mu\text{F)}$

(mean value: 100 000 sec)

Measuring voltage: 100 V/1 min.

Test specifications:

In accordance with 60384-16

Dissipation factors at $+20^\circ\text{C}$: $\tan \delta$

at f	$C \leq 2.2 \mu\text{F}$
1 kHz	$\leq 10 \times 10^{-4}$
10 kHz	$\leq 25 \times 10^{-4}$
100 kHz	$\leq 250 \times 10^{-4}$

Reference frequency 1 kHz in accordance with IEC 60384-1

Maximum pulse rise time:

PCM	max. pulse rise time t_r V/ μsec at $T_A < 40^\circ\text{C}$		
	450 VDC	520 VDC	630 VDC
10	140	200	250
15	120	160	180
22.5	100	110	130

for pulses equal to the rated voltage

Mechanical Tests

Pull test on pins:

10 N in direction of pins according to IEC 60068-2-21

Vibration:

6 hours at 10...2000 Hz and 0.75 mm displacement amplitude or 10 g in accordance with IEC 60068-2-6

Low air density:

1 kPa = 10 mbar in accordance with IEC 60068-2-13

Bump test:

4000 bumps at 390 m/sec^2 in accordance with IEC 60068-2-29

Test voltage: $1.6 U_r$, 2sec

Dielectric absorption: 0.05%

Derating:

$85^\circ\text{C} < T_A \leq 110^\circ\text{C}$: UDC; U_{rms}

Compared to nominal voltage, the admissible AC voltage (U_{rms}) and DC voltage (UDC) have to be reduced by 1.33% per K according to the graph.

$100^\circ\text{C} \leq T_A$: I_{rms} ; U_{rms}

The admissible AC voltage (U_{rms}) or the admissible AC current (I_{rms}) must be reduced by a derating factor according to the graph:

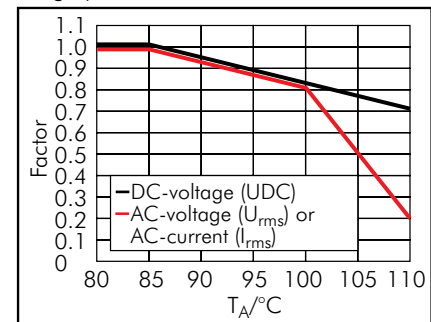

Reliability:

Operational life > 300 000 hours

Failure rate < 24 fit ($0.5 \times U_r$ and 40°C)

Packing

Available taped and reeled.

Detailed taping information and graphs at the end of the catalogue.

For further details and graphs please refer to Technical Information.

Continuation

General Data

Capacitance	450 VDC/160 VAC*					520 VDC/200 VAC*				
	W	H	L	PCM**	Part number	W	H	L	PCM**	Part number
0.068 μF	4	9	13	10	MKPCH026803C00_____	4	9	13	10	MKPCH226803C00_____
0.1 μF	4	9	13	10	MKPCH031003C00_____	5	11	13	10	MKPCH231003F00_____
	5	11	18	15	MKPCH031004B00_____					
0.15 "	4	9	13	10	MKPCH031503C00_____	5	11	13	10	MKPCH231503F00_____
	5	11	18	15	MKPCH231504B00_____					
0.22 "	5	11	13	10	MKPCH032203F00_____	6	12	13	10	MKPCH232203G00_____
	5	11	18	15	MKPCH032204B00_____					
0.33 "	6	12	13	10	MKPCH033303G00_____	6	12.5	18	15	MKPCH233304C00_____
	5	11	18	15	MKPCH033304B00_____					
0.47 "	8	12	13	10	MKPCH034703I00_____	7	14	18	15	MKPCH234704D00_____
	5	11	18	15	MKPCH034704B00_____					
0.68 "	6	12.5	18	15	MKPCH036804C00_____	9	14	18	15	MKPCH236804H00_____
	6	15	26.5	22.5	MKPCH236805B00_____					
1.0 μF	7	14	18	15	MKPCH041004D00_____	9	16	18	15	MKPCH241004J00_____
	6	15	26.5	22.5	MKPCH041005B00_____					
1.5 "	7	14	18	15	MKPCH041504D00_____	10.5	19	26.5	22.5	MKPCH241505G00_____
	7	16.5	26.5	22.5	MKPCH041505D00_____					
2.2 "	8.5	18.5	26.5	22.5	MKPCH042205F00_____	10.5	20.5	26.5	22.5	MKPCH242205H00_____

Capacitance	630 VDC/200 VAC*				
	W	H	L	PCM**	Part number
0.068 μF	4	9	13	10	MKPCJ026803C00_____
0.1 μF	5	11	13	10	MKPCJ031003F00_____
	6	12	13	10	MKPCJ031503G00_____
0.15 "	5	11	18	15	MKPCJ031504B00_____
	8	12	13	10	MKPCJ032203I00_____
0.22 "	6	12.5	18	15	MKPCJ032204C00_____
	7	14	18	15	MKPCJ033304D00_____
0.33 "	6	15	26.5	22.5	MKPCJ033305B00_____
	8	15	18	15	MKPCJ034704F00_____
0.47 "	6	15	26.5	22.5	MKPCJ034705B00_____
	9	16	18	15	MKPCJ036804H00_____
0.68 "	7	16.5	26.5	22.5	MKPCJ036805D00_____
	8.5	18.5	26.5	22.5	MKPCJ041005F00_____
1.0 μF	8.5	18.5	26.5	22.5	MKPCJ041005F00_____
1.5 "	10.5	19	26.5	22.5	MKPCJ041505G00_____
2.2 "	11	21	26.5	22.5	MKPCJ042205I00_____

Part number completion:	
Tolerance:	20 % = M
	10 % = K
	5 % = J
Packing:	bulk = S
Pin length:	6-2 = SD
Taped version see page 145.	

* AC voltages: $f \leq 1$ kHz

** PCM = Printed circuit module = pin spacing

Dims. in mm.

$d = 0.6 \phi$ if PCM = 10
 $d = 0.8 \phi$ if PCM = 15 - 22.5

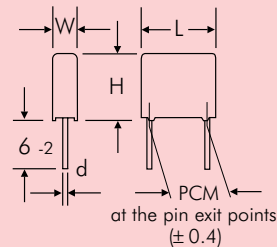

Rights reserved to amend design data without prior notification.

Continuation page 58

Continuation

Impedance change with frequency
(general guide).

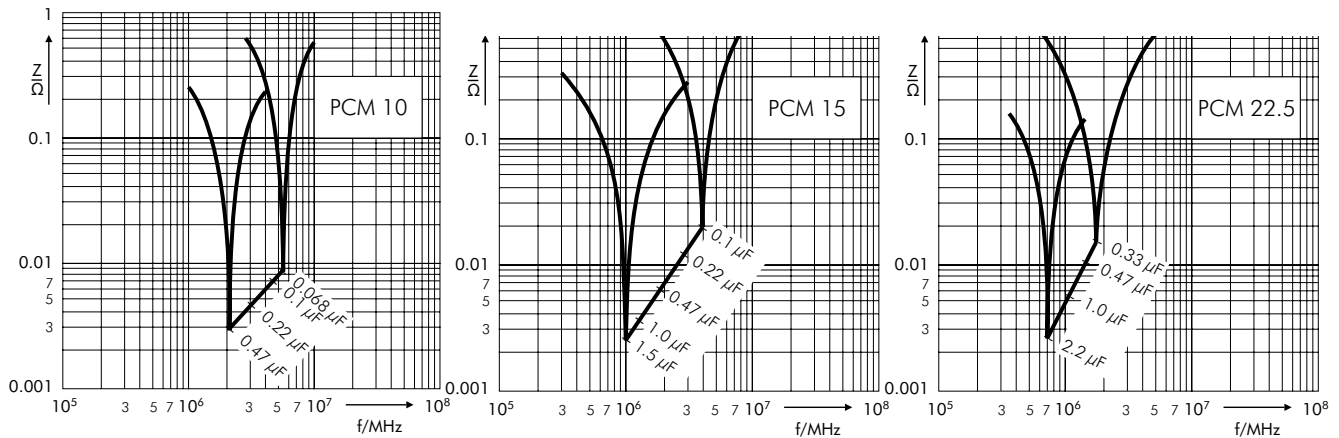

Permissible AC voltage in relation to
frequency at 10° C internal temperature rise
(general guide).

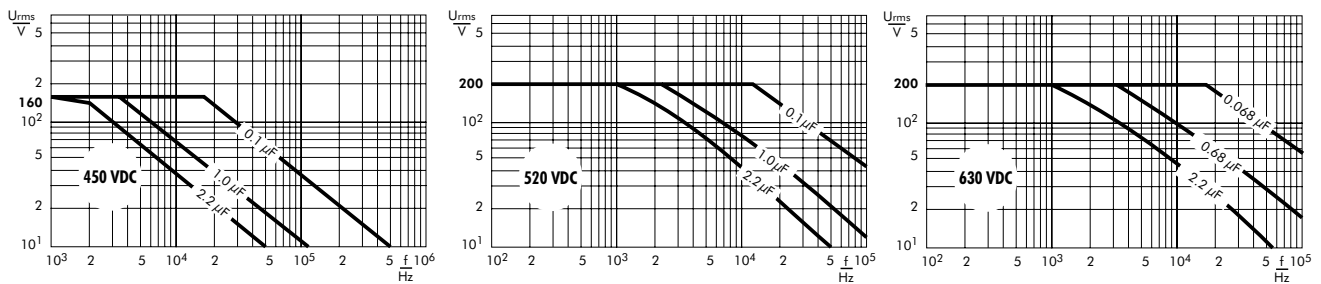

Permissible AC current in relation to
frequency at 10° C internal temperature rise
(general guide).

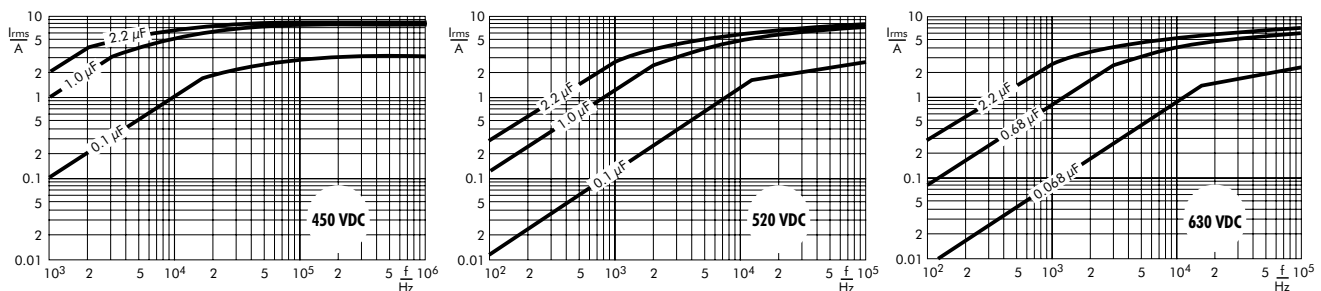

**Metallized Polypropylene (PP) Capacitors
in PCM 7.5 mm to 37.5 mm. Capacitances from 0.01 μF to 10 μF .
Rated Voltages from 100 VDC to 1000 VDC.**

Special Features

- High volume/capacitance ratio
- Self-healing
- Very low dissipation factor
- Negative capacitance change versus temperature
- Very low dielectric absorption
- According to RoHS 2011/65/EU

Typical Applications

For high frequency applications e.g.

- Sample and hold
- Timing
- Oscillating circuits
- High frequency coupling and decoupling

Construction

Dielectric:

Polypropylene (PP) film

Capacitor electrodes:

Vacuum-deposited

Internal construction:

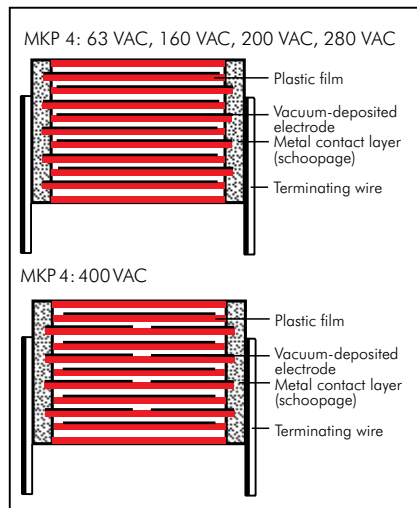

Encapsulation:

Solvent-resistant, flame-retardant plastic case with epoxy resin seal, UL 94 V-0

Terminations:

Tinned wire.

Marking:

Colour: Red. Marking: Black.
Epoxy resin seal: Red

Electrical Data

Capacitance range:

0.01 μF to 10 μF (E12-values on request)

Rated voltages:

100 VDC, 250 VDC, 400 VDC, 630 VDC, 1000 VDC

Capacitance tolerances:

$\pm 20\%$, $\pm 10\%$, $\pm 5\%$

Operating temperature range:

-55°C to $+100^\circ\text{C}$

Climatic test category:

55/100/56 in accordance with IEC

Insulation resistance at $+20^\circ\text{C}$:

$C \leq 0.33 \mu\text{F}$: $\geq 1 \times 10^5 \text{ M}\Omega$

(mean value: $5 \times 10^5 \text{ M}\Omega$)

$C > 0.33 \mu\text{F}$: $\geq 30\,000 \text{ sec (M}\Omega \times \mu\text{F)}$

(mean value: 100 000 sec)

Measuring voltage: 100 V/1 min.

Dissipation factors at $+20^\circ\text{C}$:

$\tan \delta \leq 10 \times 10^{-4}$ at 1 kHz

Maximum pulse rise time:

Capacitance μF	max. pulse rise time V/ μsec at $T_A < 40^\circ\text{C}$				
	100 VDC	250 VDC	400 VDC	630 VDC	1000 VDC
0.01 ... 0.022	450	450	450	500	550
0.033 ... 0.068	250	250	300	350	400
0.1 ... 0.22	150	150	200	250	300
0.33 ... 0.68	100	100	150	200	200
1.0 ... 2.2	75	100	100	150	150
3.3 ... 4.7	60	100	100	120	140
6.8 ... 10	40	50	60	85	–

for pulses equal to the rated voltage

Test specifications:

In accordance with IEC 60384-16

Test voltage: $1.6 U_r$, 2 sec.

Dielectric absorption: 0.05 %

Voltage derating:

A voltage derating factor of 1.35 % per K must be applied from $+85^\circ\text{C}$ for DC voltages and from $+75^\circ\text{C}$ for AC voltages.

Reliability:

Operational life $> 300\,000$ hours

Failure rate $< 2 \text{ fit (} 0.5 \times U_r \text{ and } 40^\circ\text{C)}$.

Mechanical Tests

Pull test on pins:

$d \leq 0.8 \phi$: 10 N in direction of pins

$d > 0.8 \phi$: 20 N in direction of pins

according to IEC 60068-2-21

Vibration:

6 hours at 10...2000 Hz and 0.75 mm displacement amplitude or 10 g in accordance with IEC 60068-2-6

Low air density:

1kPa = 10 mbar in accordance with

IEC 60068-2-13

Bump test:

4000 bumps at 390 m/sec²

in accordance with IEC 60068-2-29

Packing

Available taped and reeled up to and including case size 15 x 26 x 31.5 / PCM 27.5 mm.

Detailed taping information and graphs at the end of the catalogue.

For further details and graphs please refer to Technical Information.

Continuation

General Data

Capacitance	100 VDC/63 VAC*					250 VDC/160 VAC*				
	W	H	L	PCM**	Part number	W	H	L	PCM**	Part number
0.01 μ F	3	8.5	10	7.5	MKP4D021002B00_____	3	8.5	10	7.5	MKP4F021002B00_____
0.015 "	3	8.5	10	7.5	MKP4D021502B00_____	3	8.5	10	7.5	MKP4F021502B00_____
0.022 "	3	8.5	10	7.5	MKP4D022202B00_____	3	8.5	10	7.5	MKP4F022202B00_____
0.033 "	3	8.5	10	7.5	MKP4D023302B00_____	3	8.5	10	7.5	MKP4F023302B00_____
0.047 "	4	9	13	10	MKP4D023303C00_____	4	9	13	10	MKP4F023303C00_____
	4	9	10	7.5	MKP4D024702C00_____	4	9	10	7.5	MKP4F024702C00_____
0.068 "	4	9	13	10	MKP4D024703C00_____	4	9	13	10	MKP4F024703C00_____
	4	9	10	7.5	MKP4D026802C00_____	4	9	10	7.5	MKP4F026802C00_____
0.1 μ F	4	9	13	10	MKP4D026803C00_____	4	9	13	10	MKP4F026803C00_____
	4.5	9.5	10.3	7.5	MKP4D031002D00_____	4.5	9.5	10.3	7.5	MKP4F031002D00_____
0.15 "	4	9	13	10	MKP4D031003C00_____	4	9	13	10	MKP4F031003C00_____
	5	10.5	10.3	7.5	MKP4D031502E00_____	5	10.5	10.3	7.5	MKP4F031502E00_____
0.22 "	5	11	13	10	MKP4D031503F00_____	5	11	13	10	MKP4F031503F00_____
	6	12	13	10	MKP4D032203G00_____	6	12	13	10	MKP4F032203G00_____
0.33 "	5	11	18	15	MKP4D032204B00_____	5	11	18	15	MKP4F032204B00_____
	6	12.5	18	15	MKP4D033304C00_____	6	12.5	18	15	MKP4F033304C00_____
0.47 "	7	14	18	15	MKP4D034704D00_____	7	14	18	15	MKP4F034704D00_____
0.68 "	8	15	18	15	MKP4D036804F00_____	8	15	18	15	MKP4F036804F00_____
	6	15	26.5	22.5	MKP4D036805B00_____	6	15	26.5	22.5	MKP4F036805B00_____
1.0 μ F	7	16.5	26.5	22.5	MKP4D041005D00_____	7	16.5	26.5	22.5	MKP4F041005D00_____
1.5 "	10.5	19	26.5	22.5	MKP4D041505G00_____	10.5	19	26.5	22.5	MKP4F041505G00_____
2.2 "	11	21	26.5	22.5	MKP4D042205I00_____	11	21	26.5	22.5	MKP4F042205I00_____
	11	21	31.5	27.5	MKP4D042206B00_____	11	21	31.5	27.5	MKP4F042206B00_____
3.3 "	13	24	31.5	27.5	MKP4D043306D00_____	13	24	31.5	27.5	MKP4F043306D00_____
4.7 "	13	24	31.5	27.5	MKP4D044706D00_____	15	26	31.5	27.5	MKP4F044706F00_____
6.8 "	15	26	31.5	27.5	MKP4D046806F00_____	17	29	31.5	27.5	MKP4F046806G00_____
	13	24	41.5	37.5	MKP4D046807C00_____	15	26	41.5	37.5	MKP4F046807D00_____
10 μ F	17	29	41.5	37.5	MKP4D051007E00_____	19	32	41.5	37.5	MKP4F051007F00_____

* AC voltages: $f \leq 400$ Hz; $1.4 \times U_{rms} + U_{DC} \leq U_r$

** PCM = Printed circuit module = pin spacing

The high values and large box sizes according to main catalogue 2015 are still available on request.

Dims. in mm.

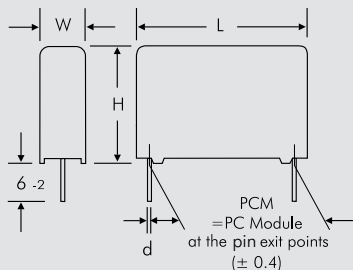

ϕ d	PCM	W
0.5	7.5	= 3
0.6	7.5	≥ 4
0.6	10	
0.8	15 - 27.5	
1.0	37.5	

Part number completion:

Tolerance: 20 % = M
10 % = K
5 % = J

Packing: bulk = S

Pin length: 6-2 = SD

Taped version see page 145.

Rights reserved to amend design data without prior notification.

Continuation page 61

Continuation

General Data

Capacitance	400 VDC/220 VAC*					630 VDC/280 VAC*				
	W	H	L	PCM**	Part number	W	H	L	PCM**	Part number
0.01 μ F	3	8.5	10	7.5	MKP4G021002B00_____	3	8.5	10	7.5	MKP4J021002B00_____
0.015 "	4	9	10	7.5	MKP4G021502C00_____	4	9	13	10	MKP4J021003C00_____
	4	9	13	10	MKP4G021503C00_____	4	9	13	10	MKP4J021502C00_____
0.022 "	4.5	9.5	10.3	7.5	MKP4G022202D00_____	4.5	9.5	10.3	7.5	MKP4J022202D00_____
	4	9	13	10	MKP4G022203C00_____	4	9	13	10	MKP4J022203C00_____
0.033 "	5	10.5	10.3	7.5	MKP4G023302E00_____	5	10.5	10.3	7.5	MKP4J023302E00_____
	4	9	13	10	MKP4G023303C00_____	4	9	13	10	MKP4J023303C00_____
0.047 "	5	10.5	10.3	7.5	MKP4G024702E00_____	5.7	12.5	10.3	7.5	MKP4J024702F00_____
	5	11	13	10	MKP4G024703F00_____	5	11	13	10	MKP4J024703F00_____
0.068 "	5.7	12.5	10.3	7.5	MKP4G026802F00_____	6	12	13	10	MKP4J026803G00_____
	5	11	13	10	MKP4G026803F00_____	6	12.5	18	15	MKP4J026804C00_____
0.1 μ F	6	12	13	10	MKP4G031003G00_____	7	14	18	15	MKP4J031004D00_____
	5	11	18	15	MKP4G031004B00_____					
0.15 "	6	12.5	18	15	MKP4G031504C00_____	8	15	18	15	MKP4J031504F00_____
						6	15	26.5	22.5	MKP4J031505B00_____
0.22 "	7	14	18	15	MKP4G032204D00_____	9	16	18	15	MKP4J032204J00_____
						7	16.5	26.5	22.5	MKP4J032205D00_____
0.33 "	8	15	18	15	MKP4G033304F00_____	8.5	18.5	26.5	22.5	MKP4J033305F00_____
	6	15	26.5	22.5	MKP4G033305B00_____					
0.47 "	7	16.5	26.5	22.5	MKP4G034705D00_____	10.5	19	26.5	22.5	MKP4J034705G00_____
						11	21	31.5	27.5	MKP4J034706B00_____
0.68 "	8.5	18.5	26.5	22.5	MKP4G036805F00_____	11	21	31.5	27.5	MKP4J036806B00_____
1.0 μ F	11	21	26.5	22.5	MKP4G041005I00_____	13	24	31.5	27.5	MKP4J041006D00_____
	11	21	31.5	27.5	MKP4G041006B00_____					
1.5 "	11	21	31.5	27.5	MKP4G041506B00_____	15	26	31.5	27.5	MKP4J041506F00_____
2.2 "	15	26	31.5	27.5	MKP4G042206F00_____	17	29	41.5	37.5	MKP4J042207E00_____
3.3 "	17	29	31.5	27.5	MKP4G043306G00_____	19	32	41.5	37.5	MKP4J043307F00_____
	17	29	41.5	37.5	MKP4G043307E00_____					
4.7 "	19	32	41.5	37.5	MKP4G044707F00_____	20	39.5	41.5	37.5	MKP4J044707G00_____
6.8 "	20	39.5	41.5	37.5	MKP4G046807G00_____	24	45.5	41.5	37.5	MKP4J046807H00_____
10 μ F	24	45.5	41.5	37.5	MKP4G051007H00_____	35	50	41.5	37.5	MKP4J051007J00_____

* AC voltages: $f \leq 400$ Hz; $1.4 \times U_{rms} + U_{DC} \leq U_r$

** PCM = Printed circuit module = pin spacing

The high values and large box sizes according to main catalogue 2015 are still available on request.

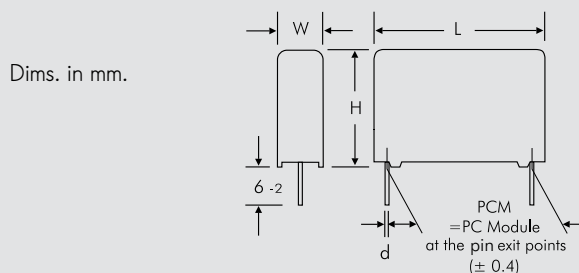

ϕ d	PCM	W
0.5	7.5	= 3
0.6	7.5	≥ 4
0.6	10	
0.8	15 - 27.5	
1.0	37.5	

Part number completion:

Tolerance: 20 % = M
10 % = K
5 % = J

Packing: bulk = S
Pin length: 6-2 = SD

Taped version see page 145.

Rights reserved to amend design data without prior notification.

Continuation page 62

Continuation

General Data

Capacitance	1000 VDC/400 VAC*				Part number
	W	H	L	PCM**	
0.01 μF	5.7	12.5	10.3	7.5	MKP4O121002F00_
	5	11	13	10	MKP4O121003F00_
0.015 "	5	11	13	10	MKP4O121503F00_
	5	11	18	15	MKP4O121504B00_
0.022 "	5	11	18	15	MKP4O122204B00_
0.033 "	6	12.5	18	15	MKP4O123304C00_
0.047 "	7	14	18	15	MKP4O124704D00_
0.068 "	8	15	18	15	MKP4O126804F00_
	6	15	26.5	22.5	MKP4O126805B00_
0.1 μF	9	16	18	15	MKP4O131004J00_
	7	16.5	26.5	22.5	MKP4O131005D00_
0.15 "	8.5	18.5	26.5	22.5	MKP4O131505F00_
0.22 "	11	21	26.5	22.5	MKP4O132205I00_
	11	21	31.5	27.5	MKP4O132206B00_
0.33 "	11	21	31.5	27.5	MKP4O133306B00_
0.47 "	13	24	31.5	27.5	MKP4O134706D00_
0.68 "	17	29	31.5	27.5	MKP4O136806G00_
1.0 μF	17	29	41.5	37.5	MKP4O141007E00_
1.5 "	20	39.5	41.5	37.5	MKP4O141507G00_
2.2 "	24	45.5	41.5	37.5	MKP4O142207H00_
3.3 "	31	46	41.5	37.5	MKP4O143307I00_
4.7 "	35	50	41.5	37.5	MKP4O144707J00_

* AC voltage: $f \leq 400 \text{ Hz}$; $1.4 \times U_{\text{rms}} + \text{UDC} \leq U_r$

** PCM = Printed circuit module = pin spacing

The high values and large box sizes according to main catalogue 2015 are still available on request.

Dims. in mm.

Part number completion:

Tolerance: 20 % = M

10 % = K

5 % = J

Packing: bulk = S

Pin length: 6-2 = SD

Taped version see page 145.

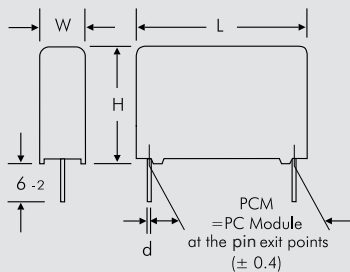

$\varnothing d$	PCM	W
0.5	7.5	= 3
0.6	7.5	≥ 4
0.6	10	
0.8	15 - 27.5	
1.0	37.5	

Rights reserved to amend design data without prior notification.

Permissible AC voltage in relation to frequency at 10° C internal temperature rise (general guide).

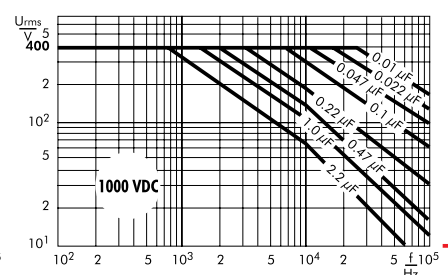
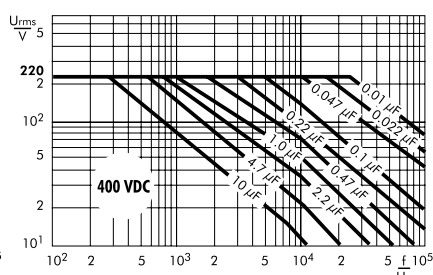
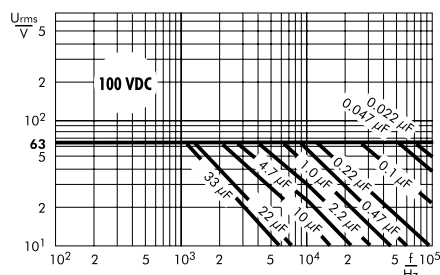
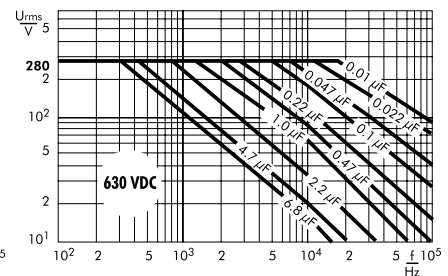
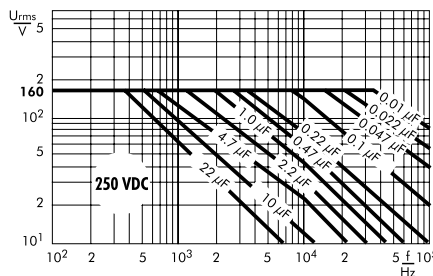

WIMA Capacitors for Good Contact at High Pulse Ratings



WIMA MKP 10

WIMA FKP 1

An important construction criterion in the manufacture of reliable, self-healing capacitors for pulse applications is the current-carrying capacity of the contacts, i.e. the connection between the terminating wires and the electrodes.

The construction principle of the WIMA MKP 10 series consists of a non-metallized dielectric film and an carrier film metallized on both sides acting as electrode. Due to the metallization on both sides, the electrical conductivity is considerably improved and the contact surface between the electrodes and the schoopage layer is doubled. This results in better contact and allows high current and pulse loading capability. The properties of metallized capacitors such as excellent self-healing

and high capacitances remain unchanged.

The WIMA FKP 1 series was developed to withstand extremely high pulse loads. It has an internal series connection, the metal foil electrodes being combined with a floating electrode metallized on both sides. The metal foil electrodes are safely contacted on both sides of the end surfaces. At the same time the capacitor is fully self-healing due to the floating electrode metallized on both sides. As regards pulse loading capability, WIMA FKP 1 represents the high-end of capacitor technology.

WIMA pulse capacitors are suitable for high pulse and high frequency applications in e.g. switch mode power supplies, TV and monitor sets, lighting industry, audio/video equipment, convertes in drives and power electronics or in electronic ballasts. They are available with capacitances from 100 pF through 47 μ F and with voltage ratings from 100 VDC through 6000 VDC.

WIMA pulse capacitors are produced with the proven box technology using solvent-resistant, flame-retardant plastic cases according to UL 94 V-0. They are environmentally compatible with the RoHS 2011/65/EU regulations.



Polypropylene (PP) Capacitors for Pulse Applications with Double-Sided Metallized Electrodes in PCM 7.5 mm to 52.5 mm. Capacitances from 1000 pF to 47 µF. Rated Voltages from 100 VDC to 3000 VDC.

Special Features

- Pulse duty construction
- Self-healing
- Very low dissipation factor
- Negative capacitance change versus temperature
- According to RoHS 2011/65/EU

Typical Applications

- For pulse applications e.g.
- Switch mode power supplies
 - TV and monitor sets
 - Lighting
 - Audio/video equipment

Construction

Dielectric: Polypropylene (PP) film
Capacitor electrodes: Double-sided metallized plastic film
Internal construction:

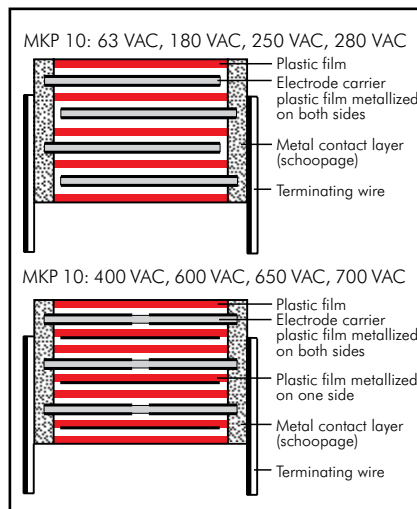

Encapsulation:

Solvent-resistant, flame-retardant plastic case with epoxy resin seal, UL 94 V-0

Terminations: Tinned wire.

Marking: Colour: Red.

Marking: Black. Epoxy resin seal: Red

Electrical Data

Capacitance range:

1000 pF to 47 µF (E12-values on request)

Rated voltages: 100 VDC, 250 VDC, 400 VDC, 630 VDC, 1000 VDC, 1600 VDC, 2000 VDC, 2500 VDC, 3000 VDC

Capacitance tolerances:

±20%, ±10%, ±5%

Operating temperature range:

-55° C to +100° C

Insulation resistance at +20° C:

$C \leq 0.33 \mu\text{F}$: $\geq 1 \times 10^5 \text{ M}\Omega$

(mean value: $5 \times 10^5 \text{ M}\Omega$)

$C > 0.33 \mu\text{F}$: $\geq 30000 \text{ sec (M}\Omega \times \mu\text{F)}$

(mean value: 100.000 sec)

Measuring voltage: 100 V/1 min.

Test voltage: 2 sec.

L	$\leq 2000 \text{ VDC}$	2500 VDC	$\geq 3000 \text{ VDC}$
< 41.5	1.6 U_r	1.4 U_r	1.2 U_r
41.5	1.4 U_r	1.4 U_r	1.2 U_r
57	1.2 U_r	1.2 U_r	1.2 U_r

Climatic test category:

55/100/56 in accordance with IEC

Dielectric absorption: 0.05%

Voltage derating:

A voltage derating factor of 1.35 % per K must be applied from +85° C for DC voltages and from +75° C for AC voltages.

Reliability:

Operational life > 300 000 hours

Failure rate < 1 fit (0.5 x U_r and 40° C)

Specific dissipation:

Box size* WxHxL in mm	Specific dissipation in Watts per K above the ambient temperature
35 x 50 x 57	0.132
45 x 55 x 57	0.164
45 x 65 x 57	0.184

* other box sizes see page 11.

Dissipation factors at +20° C: $\tan \delta$

at f	$C \leq 0.1 \mu\text{F}$	$0.1 \mu\text{F} < C \leq 1.0 \mu\text{F}$	$C > 1.0 \mu\text{F}$
1 kHz	$\leq 6 \times 10^{-4}$	$\leq 6 \times 10^{-4}$	$\leq 6 \times 10^{-4}$
10 kHz	$\leq 6 \times 10^{-4}$	$\leq 6 \times 10^{-4}$	-
100 kHz	$\leq 15 \times 10^{-4}$	-	-

Maximum pulse rise time for pulses equal to the rated voltage

Capacitance pF/µF	max. pulse rise time V/µsec at $T_A < 40^\circ \text{C}$									
	100 VDC	250 VDC	400 VDC	630 VDC	1000 VDC	1600 VDC	2000 VDC	2500 VDC	3000 VDC	
1000 ... 2200	1250	2300	2300	2300	3500	7000	11500	11500	-	
3300 ... 6800	1150	1500	1500	1500	3500	7000	11500	11500	-	
0.01 ... 0.022	900	1400	1500	1500	2700	3800	4400	11500	-	
0.033 ... 0.068	500	1000	1150	1400	2700	2700	2700	2700	2700	
0.1 ... 0.22	250	650	650	1150	1800	1800	1800	1800	1800	
0.33 ... 0.68	130	390	500	900	1150	1150	1150	1150	1150	
1.0 ... 2.2	90	250	250	500	500	650	650	650	500	
3.3 ... 4.7	65	100	130	190	230	330	-	-	-	
6.8 ... 15	45	65	90	160	-	-	-	-	-	
22 ... 47	30	45	45	-	-	-	-	-	-	

Mechanical Tests

Pull test on pins:

$d \leq 0.8 \phi$: 10 N in direction of pins

$d > 0.8 \phi$: 20 N in direction of pins

according to IEC 60068-2-21

Vibration: 6 hours at 10...2000 Hz and

0.75 mm displacement amplitude or 10 g

in accordance with IEC 60068-2-6

Low air density: 1kPa = 10 mbar in

accordance with IEC 60068-2-13

Bump test: 4000 bumps at 390 m/sec²

in accordance with IEC 60068-2-29

Packing

Available taped and reeled up to and including case size 15 x 26 x 31.5 / PCM 27.5 mm.

Detailed taping information and graphs at the end of the catalogue.

For further details and graphs please refer to Technical Information.

Continuation

General Data

Capacitance	100 VDC/63 VAC*					250 VDC/180 VAC*				
	W	H	L	PCM**	Part number	W	H	L	PCM**	Part number
1000 pF	4	9	10	7.5	MKP1D011002C	4	9	10	7.5	MKP1F011002C
1500 "	4	9	10	7.5	MKP1D011502C	4	9	10	7.5	MKP1F011502C
2200 "	4	9	10	7.5	MKP1D012202C	4	9	10	7.5	MKP1F012202C
3300 "	4	9	10	7.5	MKP1D013302C	4	9	10	7.5	MKP1F013302C
4700 "	4	9	10	7.5	MKP1D014702C	4	9	10	7.5	MKP1F014702C
6800 "	4	9	10	7.5	MKP1D016802C	4	9	10	7.5	MKP1F016802C
0.01 µF	4	9	10	7.5	MKP1D021002C	4	9	10	7.5	MKP1F021002C
0.015 "	4	9	10	7.5	MKP1D021502C	4	9	10	7.5	MKP1F021502C
0.022 "	4	9	10	7.5	MKP1D022202C	4	9	10	7.5	MKP1F022202C
0.033 "	5	10.5	10.3	7.5	MKP1D023302E	5	10.5	10.3	7.5	MKP1F023302E
0.047 "	4	9	13	10	MKP1D023303C	4	9	13	10	MKP1F023303C
0.068 "	5	10.5	10.3	7.5	MKP1D024702E	5	10.5	10.3	7.5	MKP1F024702E
	4	9	13	10	MKP1D024703C	4	9	13	10	MKP1F024703C
	5	11	13	10	MKP1D026803F	5	11	13	10	MKP1F026803F
0.1 µF	6	12	13	10	MKP1D031003G	6	12	13	10	MKP1F031003G
0.15 "	6	12.5	18	15	MKP1D031504C	6	12.5	18	15	MKP1F031504C
0.22 "	7	14	18	15	MKP1D032204D	7	14	18	15	MKP1F032204D
0.33 "	8	15	18	15	MKP1D033304F	8	15	18	15	MKP1F033304F
0.47 "	9	16	18	15	MKP1D034704J	9	16	18	15	MKP1F034704J
0.68 "	7	16.5	26.5	22.5	MKP1D034705D	7	16.5	26.5	22.5	MKP1F034705D
	8.5	18.5	26.5	22.5	MKP1D036805F	8.5	18.5	26.5	22.5	MKP1F036805F
1.0 µF	10.5	19	26.5	22.5	MKP1D041005G	11	21	26.5	22.5	MKP1F041005I
1.5 "	11	21	31.5	27.5	MKP1D041506B	11	21	31.5	27.5	MKP1F041006B
2.2 "	13	24	31.5	27.5	MKP1D042206D	13	24	31.5	27.5	MKP1F041506D
3.3 "	17	29	31.5	27.5	MKP1D043306G	13	24	41.5	37.5	MKP1F041507C
4.7 "	20	39.5	31.5	27.5	MKP1D044706J	15	26	31.5	27.5	MKP1F042206F
6.8 "	17	29	41.5	37.5	MKP1D044707E	13	24	41.5	37.5	MKP1F042207C
	19	32	41.5	37.5	MKP1D046807F	17	34.5	31.5	27.5	MKP1F043306I
10 µF	20	39.5	41.5	37.5	MKP1D051007G	17	29	41.5	37.5	MKP1F043307E
15 "	24	45.5	41.5	37.5	MKP1D051507H	20	39.5	31.5	27.5	MKP1F044706J
22 "	31	46	41.5	37.5	MKP1D051507I	19	32	41.5	37.5	MKP1F044707E
33 "	35	50	41.5	37.5	MKP1D052207J	20	39.5	41.5	37.5	MKP1F046807G
47 "	40	55	41.5	37.5	MKP1D053307K	24	45.5	41.5	37.5	MKP1F051007H
	35	50	57	52.5	MKP1D053309F	35	50	41.5	37.5	MKP1F051507J
	45	65	57	52.5	MKP1D054709J	35	50	57	52.5	MKP1F051509F
						45	65	57	52.5	MKP1F052209F
										MKP1F053309J

* AC voltage: $f \leq 1000 \text{ Hz}$; $1.4 \times U_{\text{rms}} + U_{\text{DC}} \leq U_r$

** PCM = Printed circuit module = pin spacing

Dims. in mm.

Ionisation inception level in isolated cases may be lower than admissible rated AC voltage.

Rights reserved to amend design data without prior notification.

Part number completion:

Version code:	2-pin	= 00
	4-pin	= D4
Tolerance:	20 %	= M
	10 %	= K
	5 %	= J
Packing:	bulk	= S
Pin length:	6-2	= SD
Taped version see page 145.		



Continuation

General Data

Capacitance	400 VDC/250 VAC*					630 VDC/400 VAC*				
	W	H	L	PCM**	Part number	W	H	L	PCM**	Part number
1000 pF	4	9	10	7.5	MKP1G011002C	4	9	10	7.5*	MKP1J011002C
1500 "	4	9	10	7.5	MKP1G011502C	4	9	10	7.5*	MKP1J011502C
2200 "	4	9	10	7.5	MKP1G012202C	4	9	10	7.5*	MKP1J012202C
3300 "	4	9	10	7.5	MKP1G013302C	4	9	10	7.5*	MKP1J013302C
4700 "	4	9	10	7.5	MKP1G014702C	4	9	10	7.5*	MKP1J014702C
6800 "	4	9	10	7.5	MKP1G016802C	4	9	10	7.5*	MKP1J016802C
						4	9	13	10	MKP1J016803C
0.01 µF	4	9	10	7.5	MKP1G021002C	5	10.5	10.3	7.5*	MKP1J021002E
	4	9	13	10	MKP1G021003C	4	9	13	10	MKP1J021003C
0.015 "	5	10.5	10.3	7.5	MKP1G021502E	5	11	13	10	MKP1J021503F
	4	9	13	10	MKP1G021503C	5	11	18	15	MKP1J021504B
0.022 "	5	10.5	10.3	7.5	MKP1G022202E	5	11	13	10	MKP1J022203F
	4	9	13	10	MKP1G022203C	5	11	18	15	MKP1J022204B
0.033 "	5.7	12.5	10.3	7.5	MKP1G023302F	6	12	13	10	MKP1J023303G
	5	11	13	10	MKP1G023303F	5	11	18	15	MKP1J023304B
0.047 "	6	12	13	10	MKP1G024703G	6	12.5	18	15	MKP1J024704C
	5	11	18	15	MKP1G024704B	6	15	26.5	22.5	MKP1J024705B
0.068 "	6	12.5	18	15	MKP1G026804C	7	14	18	15	MKP1J026804D
	6	15	26.5	22.5	MKP1G026805B	6	15	26.5	22.5	MKP1J026805B
0.1 µF	7	14	18	15	MKP1G031004D	9	16	18	15	MKP1J031004J
	6	15	26.5	22.5	MKP1G031005B	7	16.5	26.5	22.5	MKP1J031005D
0.15 "	8	15	18	15	MKP1G031504F	8.5	18.5	26.5	22.5	MKP1J031505F
	6	15	26.5	22.5	MKP1G031505B	9	19	31.5	27.5	MKP1J031506A
0.22 "	9	16	18	15	MKP1G032204J	8.5	18.5	26.5	22.5	MKP1J032205F
	7	16.5	26.5	22.5	MKP1G032205D	9	19	31.5	27.5	MKP1J032206A
0.33 "	8.5	18.5	26.5	22.5	MKP1G033305F	11	21	26.5	22.5	MKP1J033305I
	9	19	31.5	27.5	MKP1G033306A	11	21	31.5	27.5	MKP1J033306B
0.47 "	10.5	19	26.5	22.5	MKP1G034705G	11	21	31.5	27.5	MKP1J034706B
	9	19	31.5	27.5	MKP1G034706A					
0.68 "	11	21	26.5	22.5	MKP1G036805I	15	26	31.5	27.5	MKP1J036806F
	11	21	31.5	27.5	MKP1G036806B	13	24	41.5	37.5	MKP1J036807C
1.0 µF	13	24	31.5	27.5	MKP1G041006D	17	29	31.5	27.5	MKP1J041006G
	13	24	41.5	37.5	MKP1G041007C	15	26	41.5	37.5	MKP1J041007D
1.5 "	17	29	31.5	27.5	MKP1G041506G	20	39.5	31.5	27.5	MKP1J041506J
	13	24	41.5	37.5	MKP1G041507C	19	32	41.5	37.5	MKP1J041507F
2.2 "	20	39.5	31.5	27.5	MKP1G042206J	20	39.5	41.5	37.5	MKP1J042207G
	17	29	41.5	37.5	MKP1G042207E					
3.3 "	20	39.5	41.5	37.5	MKP1G043307G	24	45.5	41.5	37.5	MKP1J043307H
4.7 "	20	39.5	41.5	37.5	MKP1G044707G	35	50	41.5	37.5	MKP1J044707J
6.8 "	24	45.5	41.5	37.5	MKP1G046807H	40	55	41.5	37.5	MKP1J046807K
						35	50	57	52.5	MKP1J046809F
10 µF	35	50	41.5	37.5	MKP1G051007J	45	55	57	52.5	MKP1J051009H
	35	50	57	52.5	MKP1G051009F					
15 "	40	55	41.5	37.5	MKP1G051507K					
	35	50	57	52.5	MKP1G051509F					
22 "	45	65	57	52.5	MKP1G052209J					

* AC voltage: $f \leq 1000 \text{ Hz}$; $1.4 \times U_{\text{rms}} + U_{\text{DC}} \leq U_r$

** PCM = Printed circuit module = pin spacing

* Admissible AC voltage 280 VAC.

Dims. in mm.

Ionisation inception level in isolated cases may be lower than admissible rated AC voltage.

Part number completion:	
Version code:	2-pin = 00 4-pin = D4
Tolerance:	20 % = M 10 % = K 5 % = J
Packing:	bulk = S
Pin length:	6-2 = SD
Taped version see page 145.	

Rights reserved to amend design data without prior notification.

Continuation

General Data

Capacitance	1000 VDC/600 VAC*					1600 VDC/650 VAC*				
	W	H	L	PCM**	Part number	W	H	L	PCM**	Part number
1000 pF	4	9	10	7.5	MKP1O111002C_____	4	9	13	10	MKP1T011003C_____
	4	9	13	10	MKP1O111003C_____					
1500 "	4	9	10	7.5	MKP1O111502C_____	4	9	13	10	MKP1T011503C_____
	4	9	13	10	MKP1O111503C_____					
2200 "	4	9	10	7.5	MKP1O112202C_____	4	9	13	10	MKP1T012203C_____
	4	9	13	10	MKP1O112203C_____					
3300 "	4	9	10	7.5	MKP1O113302C_____	4	9	13	10	MKP1T013303C_____
	4	9	13	10	MKP1O113303C_____					
4700 "	4.5	9.5	10.3	7.5	MKP1O114702D_____	5	11	13	10	MKP1T014703F_____
	4	9	13	10	MKP1O114703C_____					
6800 "	5.7	12.5	10.3	7.5	MKP1O116802F_____	6	12	13	10	MKP1T016803G_____
	5	11	13	10	MKP1O116803F_____					
0.01 µF	5	11	13	10	MKP1O121003F_____	5	11	18	15	MKP1T021004B_____
	5	11	18	15	MKP1O121004B_____					
0.015 "	6	12	13	10	MKP1O121503G_____	6	12.5	18	15	MKP1T021504C_____
	5	11	18	15	MKP1O121504B_____					
0.022 "	6	12.5	18	15	MKP1O122204C_____	7	14	18	15	MKP1T022204D_____
	6	15	26.5	22.5	MKP1O122205B_____					
0.033 "	7	14	18	15	MKP1O123304D_____	8	15	18	15	MKP1T023304F_____
	6	15	26.5	22.5	MKP1O123305B_____					
0.047 "	8	15	18	15	MKP1O124704F_____	7	16.5	26.5	22.5	MKP1T024705D_____
	6	15	26.5	22.5	MKP1O124705B_____					
0.068 "	7	16.5	26.5	22.5	MKP1O126805D_____	10.5	19	26.5	22.5	MKP1T026805G_____
0.1 µF	8.5	18.5	26.5	22.5	MKP1O131005F_____	11	21	26.5	22.5	MKP1T031005I_____
	11	21	31.5	27.5	MKP1O131006B_____					
0.15 "	11	21	26.5	22.5	MKP1O131505I_____	13	24	31.5	27.5	MKP1T031506D_____
	11	21	31.5	27.5	MKP1O131506B_____					
0.22 "	11	21	31.5	27.5	MKP1O132206B_____	15	26	31.5	27.5	MKP1T032206F_____
0.33 "	13	24	31.5	27.5	MKP1O133306D_____	17	34.5	31.5	27.5	MKP1T033306I_____
	15	26	31.5	27.5	MKP1O133306F_____					
0.47 "	13	24	41.5	37.5	MKP1O133307C_____	17	29	41.5	37.5	MKP1T033307E_____
	17	29	31.5	27.5	MKP1O134706G_____					
0.68 "	13	24	41.5	37.5	MKP1O134707C_____	20	39.5	31.5	27.5	MKP1T034706J_____
	20	39.5	31.5	27.5	MKP1O136806J_____					
	17	29	41.5	37.5	MKP1O136807E_____	20	39.5	41.5	37.5	MKP1T036807G_____
1.0 µF	20	39.5	41.5	37.5	MKP1O141007G_____	24	45.5	41.5	37.5	MKP1T041007H_____
1.5 "	24	45.5	41.5	37.5	MKP1O141507H_____	31	46	41.5	37.5	MKP1T041507I_____
2.2 "	31	46	41.5	37.5	MKP1O142207I_____	40	55	41.5	37.5	MKP1T042207K_____
3.3 "	40	55	41.5	37.5	MKP1O143307K_____	35	50	57	52.5	MKP1T042209F_____
						45	55	57	52.5	MKP1O144709H_____

* AC voltage: $f \leq 1000 \text{ Hz}$; $1.4 \times U_{\text{rms}} + U_{\text{DC}} \leq U_r$

** PCM = Printed circuit module = pin spacing

Dims. in mm.

Ionisation inception level in isolated cases may be lower than admissible rated AC voltage.

Rights reserved to amend design data without prior notification.

Part number completion:

Version code:	2-pin = 00
	4-pin = D4
Tolerance:	20 % = M
	10 % = K
	5 % = J
Packing:	bulk = S
Pin length:	6-2 = SD
Taped version see page 145.	

Continuation page 68

Continuation

General Data

Capacitance	2000 VDC/700 VAC*					2500 VDC/700 VAC*				
	W	H	L	PCM**	Part number	W	H	L	PCM**	Part number
1000 pF	4	9	13	10	MKP1U011003C_____	5	11	18	15	MKP1V011004B_____
						6	15	26.5	22.5	MKP1V011005B_____
1500 "	4	9	13	10	MKP1U011503C_____	5	11	18	15	MKP1V011504B_____
						6	15	26.5	22.5	MKP1V011505B_____
2200 "	5	11	13	10	MKP1U012203F_____	5	11	18	15	MKP1V012204B_____
						6	15	26.5	22.5	MKP1V012205B_____
3300 "	5	11	18	15	MKP1U013304B_____	5	11	18	15	MKP1V013304B_____
						6	15	26.5	22.5	MKP1V013305B_____
4700 "	5	11	18	15	MKP1U014704B_____	6	12.5	18	15	MKP1V014704C_____
						6	15	26.5	22.5	MKP1V014705B_____
6800 "	6	12.5	18	15	MKP1U016804C_____	7	14	18	15	MKP1V016804D_____
						6	15	26.5	22.5	MKP1U016805B_____
0.01 µF	7	14	18	15	MKP1U021004D_____	8.5	18.5	26.5	22.5	MKP1V021005F_____
0.015 "	8	15	18	15	MKP1U021504F_____	10.5	19	26.5	22.5	MKP1V021505G_____
0.022 "	9	16	18	15	MKP1U022204J_____	11	21	26.5	22.5	MKP1V022205I_____
0.033 "	8.5	18.5	26.5	22.5	MKP1U023305F_____	11	21	26.5	22.5	MKP1V023305I_____
0.047 "	10.5	19	26.5	22.5	MKP1U024705G_____	11	21	31.5	27.5	MKP1V024706B_____
0.068 "	11	21	26.5	22.5	MKP1U026805I_____	13	24	31.5	27.5	MKP1V026806D_____
0.1 µF	13	24	31.5	27.5	MKP1U031006D_____	15	26	31.5	27.5	MKP1V031006F_____
0.15 "	15	26	31.5	27.5	MKP1U031506F_____	17	34.5	31.5	27.5	MKP1V031506I_____
0.22 "	17	34.5	31.5	27.5	MKP1U032206I_____	15	26	41.5	37.5	MKP1V031507D_____
0.33 "	19	32	41.5	37.5	MKP1U033307F_____	24	45.5	41.5	37.5	MKP1V033307H_____
0.47 "	20	39.5	41.5	37.5	MKP1U034707G_____	31	46	41.5	37.5	MKP1V034707I_____
1.0 µF	35	50	41.5	37.5	MKP1U041007J_____	40	55	41.5	37.5	MKP1V041007K_____
1.5 "	40	55	41.5	37.5	MKP1U041507K_____	45	55	57	52.5	MKP1V041509H_____
2.2 "	45	55	57	52.5	MKP1U042209H_____					

* AC voltage: $f \leq 1000 \text{ Hz}$; $1.4 \times U_{\text{rms}} + \text{UDC} \leq U_r$

■ New values

** PCM = Printed circuit module = pin spacing

Dims. in mm.

Ionisation inception level in isolated cases may be lower than admissible rated AC voltage.

Rights reserved to amend design data without prior notification.

Part number completion:

Version code:	2-pin	= 00
	4-pin	= D4
Tolerance:	20 %	= M
	10 %	= K
	5 %	= J
Packing:	bulk	= S
Pin length:	6-2	= SD
Taped version see page 145.		

Continuation page 69

Continuation

General Data

Capacitance	3000 VDC/700 VAC*				Part number
	W	H	L	PCM**	
0.01 μ F	8.5	18.5	26.5	22,5	MKP1W021005F
0.015 "	10.5	19	26.5	22,5	MKP1W021505G
0.022 "	11	21	26.5	22,5	MKP1W022205I
0.033 "	11	21	26.5	22,5	MKP1W023305L
	9	19	31.5	27.5	MKP1W023306A
0.047 "	11	21	31.5	27.5	MKP1W024706B
0.068 "	13	24	31.5	27.5	MKP1W026806D
0.1 μ F	15	26	31.5	27.5	MKP1W031006F
	13	24	41.5	37.5	MKP1W031007C
0.15 "	17	34.5	31.5	27.5	MKP1W031506I
	15	26	41.5	37.5	MKP1W031507D
0.22 "	19	32	41.5	37.5	MKP1W032207F
0.33 "	24	45.5	41.5	37.5	MKP1W033307H
0.47 "	31	46	41.5	37.5	MKP1W034707I
0.68 "	35	50	41.5	37.5	MKP1W036807J
1.0 μ F	40	55	41.5	37.5	MKP1W041007K
	35	50	57	52.5	MKP1W041009F
1.5 "	45	55	57	52.5	MKP1W041509H

* AC voltage: $f \leq 1000$ Hz; $1.4 \times U_{rms} + U_{DC} \leq U_r$

New box sizes

** PCM = Printed circuit module = pin spacing

Dims. in mm.

The box sizes according to the main catalogue 2015 are still available on request

Ionisation inception level in isolated cases may be lower than admissible rated AC voltage.

Part number completion:

Version code:	2-pin	= 00
	4-pin	= D4
Tolerance:	20 %	= M
	10 %	= K
	5 %	= J
Packing:	bulk	= S
Pin length:	6-2	= SD
Taped version see page 145.		

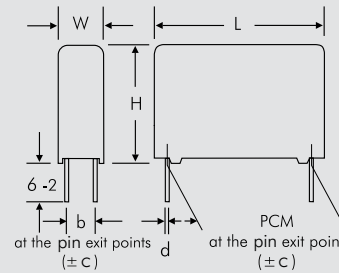
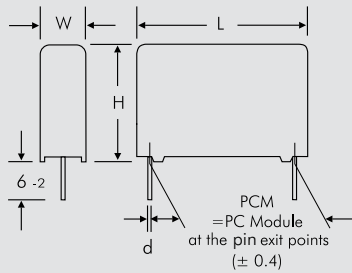

Rights reserved to amend design data without prior notification.

Permissible AC voltage in relation to frequency at 10° C internal temperature rise (general guide).

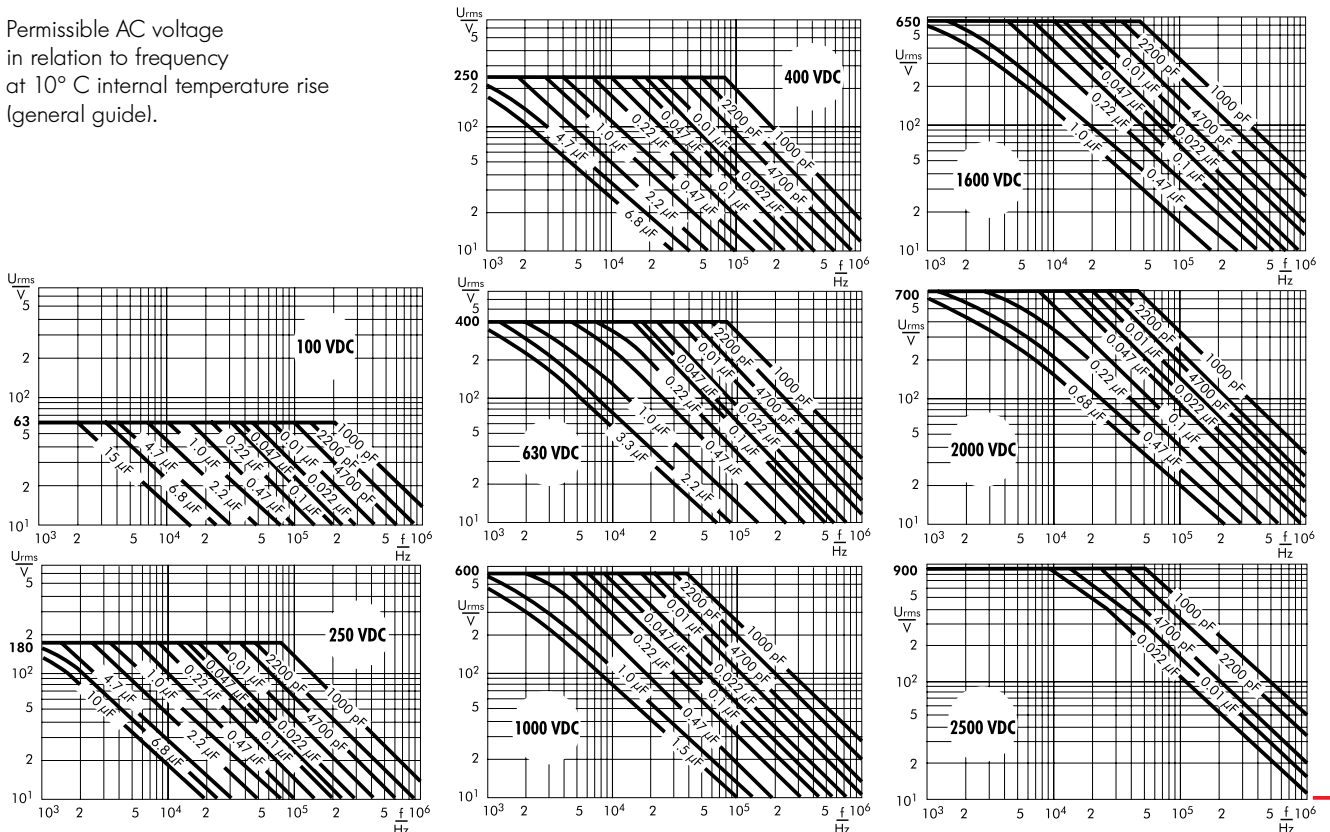

Polypropylene (PP) Capacitors for Pulse Applications with Metal Foil Electrodes and Metallized Internal Series Connection in PCM 15 mm to 52.5 mm. Capacitances from 100 pF to 4.7 μF. Rated Voltages from 400 VDC to 6000 VDC.

Special Features

- Extremely high pulse duty
- Self-healing
- Internal series connection
- Very low dissipation factor
- Negative capacitance change versus temperature
- According to RoHS 2011/65/EU

Typical Applications

For high pulse and high frequency applications e.g.

- Switch mode power supplies
- Converters in drives and power electronics
- Deflection systems in monitors and TV-sets
- Electronic ballasts

Construction

Dielectric:

Polypropylene (PP) film

Capacitor electrodes:

Aluminium foil and double-sided metallized plastic film

Internal construction:

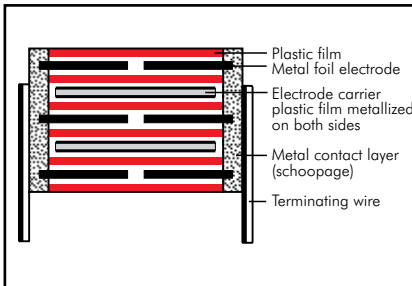

Encapsulation:

Solvent-resistant, flame-retardant plastic case with epoxy resin seal, UL 94 V-0

Terminations:

Tinned wire.

Marking:

Colour: Red. Marking: Black.

Epoxy resin seal: Yellow

Electrical Data

Capacitance range:

100 pF to 4.7 μF (E12-values on request)

Rated voltages:

400 VDC, 630 VDC, 1000 VDC, 1250 VDC, 1600 VDC, 2000 VDC, 4000 VDC, 6000 VDC

Capacitance tolerances:

±20%, ±10%, ±5% (other tolerances are available subject to special enquiry)

Operating temperature range:

-55° C to +100° C

Climatic test category:

55/100/56 in accordance with IEC

Test voltage:

2 U_r, 2 sec / 6 kV: 1.6 U_r, 2 sec.

Dielectric absorption: 0.05%

Dissipation factors at +20° C: tan δ

at f	C ≤ 0.1 μF	0.1 μF < C ≤ 1.0 μF	C > 1.0 μF
1 kHz	≤ 6x10 ⁻⁴	≤ 6x10 ⁻⁴	≤ 6x10 ⁻⁴
10 kHz	≤ 6x10 ⁻⁴	≤ 6x10 ⁻⁴	-
100 kHz	≤ 10x10 ⁻⁴	-	-

Insulation resistance at +20° C:

C ≤ 0.1 μF: ≥ 1 x 10⁵ MΩ

(mean value: 5 x 10⁵ MΩ)

C > 0.1 μF: ≥ 30 000 sec (MΩ x μF)

(mean value: 100 000 sec)

Measuring voltage: 100 V/1 min.

Voltage derating:

A voltage derating factor of 1.35 % per K

must be applied from +85° C for DC

voltages and from +75° C for AC

voltages

Reliability:

Operational life > 300 000 hours

Failure rate < 1 fit (0.5 x U_r and 40° C)

Maximum pulse rise time: for pulses equal to the rated voltage

Capacitance pF/μF	max. pulse rise time V/μsec at T _A < 40° C							
	400VDC	630VDC	1000VDC	1250VDC	1600VDC	2000VDC	4000VDC	6000VDC
100 ... 220	-	-	-	-	56000	56000	-	-
330 ... 680	-	-	-	-	51000	56000	56000	56000
1000 ... 2200	29000	29000	29000	29000	46000	51000	51000	51000
3300 ... 6800	9000	14000	27000	29000	29000	29000	29000	29000
0.01 ... 0.022	9000	11000	11000	11000	11000	13000	13000	13000
0.033 ... 0.068	9000	11000	11000	11000	11000	11000	13000	13000
0.1 ... 0.22	7000	11000	11000	11000	11000	11000	13000	13000
0.33 ... 0.68	6000	10000	11000	11000	11000	11000	-	-
1.0 ... 2.2	5000	6600	8300	9500	11000	-	-	-
3.3 ... 4.7	2500	-	-	-	-	-	-	-

Mechanical Tests

Pull test on pins:

d ≤ 0.8 φ: 10 N in direction of pins

d > 0.8 φ: 20 N in direction of pins

according to IEC 60068-2-21

Vibration:

6 hours at 10 ... 2000 Hz and 0.75 mm

displacement amplitude or 10 g in

accordance with IEC 60068-2-6

Low air density:

1kPa = 10 mbar in accordance with

IEC 60068-2-13

Bump test:

4000 bumps at 390 m/sec²

in accordance with IEC 60068-2-29

Packing

Available taped and reeled up to and

including case size 15 x 26 x 31.5 /

PCM 27.5 mm.

Detailed taping information and graphs

at the end of the catalogue.

For further details and graphs please

refer to Technical Information.

Continuation

General Data

Capacitance	400 VDC/250 VAC*					630 VDC/400 VAC*				
	W	H	L	PCM**	Part number	W	H	L	PCM**	Part number
1000 pF	5	11	18	15	FKP1G011004B_____	5	11	18	15	FKP1J011004B_____
1500 „	5	11	18	15	FKP1G011504B_____	5	11	18	15	FKP1J011504B_____
2200 „	5	11	18	15	FKP1G012204B_____	5	11	18	15	FKP1J012204B_____
3300 „	5	11	18	15	FKP1G013304B_____	5	11	18	15	FKP1J013304B_____
4700 „	5	11	18	15	FKP1G014704B_____	5	11	18	15	FKP1J014704B_____
6800 „	5	11	18	15	FKP1G016804B_____	6	12.5	18	15	FKP1J016804C_____
0.01 µF	5	11	18	15	FKP1G021004B_____	7	14	18	15	FKP1J021004D_____
0.015 „	6	12.5	18	15	FKP1G021504C_____	5	14	26.5	22.5	FKP1J021005A_____
0.022 „	7	14	18	15	FKP1G022204D_____	8	15	18	15	FKP1J021504F_____
0.033 „	5	14	26.5	22.5	FKP1G022205A_____	6	15	26.5	22.5	FKP1J021505B_____
0.047 „	8	15	18	15	FKP1G023304F_____	7	16.5	26.5	22.5	FKP1J022205D_____
0.068 „	6	15	26.5	22.5	FKP1G023305B_____	8.5	18.5	26.5	22.5	FKP1J023305F_____
	7	16.5	26.5	22.5	FKP1G024705D_____	10.5	20.5	26.5	22.5	FKP1J024705H_____
	8.5	18.5	26.5	22.5	FKP1G026805F_____	9	19	31.5	27.5	FKP1J024706A_____
						11	21	31.5	27.5	FKP1J026806B_____
						9	19	41.5	37.5	FKP1J026807A_____
0.1 µF	10.5	20.5	26.5	22.5	FKP1G031005H_____	13	24	31.5	27.5	FKP1J031006D_____
	9	19	31.5	27.5	FKP1G031006A_____	11	22	41.5	37.5	FKP1J031007B_____
0.15 „	11	21	31.5	27.5	FKP1G031506B_____	13	24	41.5	37.5	FKP1J031507C_____
0.22 „	13	24	31.5	27.5	FKP1G032206D_____	15	26	41.5	37.5	FKP1J032207D_____
	11	22	41.5	37.5	FKP1G032207B_____					
0.33 „	13	24	41.5	37.5	FKP1G033307C_____	19	32	41.5	37.5	FKP1J033307F_____
0.47 „	17	29	41.5	37.5	FKP1G034707E_____	20	39.5	41.5	37.5	FKP1J034707G_____
0.68 „	19	32	41.5	37.5	FKP1G036807F_____	24	45.5	41.5	37.5	FKP1J036807H_____
1.0 µF	20	39.5	41.5	37.5	FKP1G041007G_____	35	50	41.5	37.5	FKP1J041007J_____
1.5 „	31	46	41.5	37.5	FKP1G041507I_____	40	55	41.5	37.5	FKP1J041507K_____
						35	50	57	52.5	FKP1J041509F_____
2.2 „	35	50	41.5	37.5	FKP1G042207J_____	45	55	57	52.5	FKP1J042209H_____
3.3 „	35	50	57	52.5	FKP1G043309F_____					
4.7 „	45	65	57	52.5	FKP1G044709J_____					

* AC voltages: $f \leq 1000 \text{ Hz}$; $1.4 \times U_{\text{rms}} + \text{UDC} \leq U_r$

 New values

** PCM = Printed circuit module = pin spacing

Dims. in mm.

The values of the WIMA FKP 4 range according to main catalogue 2015 are still available on request.

Ionisation inception level in isolated cases may be lower than admissible rated AC voltage.

Part number completion:

Version code:	2-pin	= 00
	4-pin	= D4
Tolerance:	20 %	= M
	10 %	= K
	5 %	= J
Packing:	bulk	= S
Pin length:	6-2	= SD
Taped version see page 145.		

Rights reserved to amend design data without prior notification.

Continuation page 72

Continuation

General Data

Capacitance	1000 VDC/600 VAC*					1250 VDC/600 VAC*				
	W	H	L	PCM**	Part number	W	H	L	PCM**	Part number
1000 pF	5	11	18	15	FKP1O111004B_	5	11	18	15	FKP1R011004B_
1500 "	5	11	18	15	FKP1O111504B_	5	11	18	15	FKP1R011504B_
2200 "	5	11	18	15	FKP1O112204B_	5	11	18	15	FKP1R012204B_
3300 "	5	11	18	15	FKP1O113304B_	6	12.5	18	15	FKP1R013304C_
4700 "	6	12.5	18	15	FKP1O114704C_	7	14	18	15	FKP1R014704D_
6800 "	7	14	18	15	FKP1O116804D_	8	15	18	15	FKP1R016804F_
						5	14	26.5	22.5	FKP1R016805A_
0.01 µF	8	15	18	15	FKP1O121004F_	7	16.5	26.5	22.5	FKP1R021005D_
	6	15	26.5	22.5	FKP1O121005B_					
0.015 "	6	15	26.5	22.5	FKP1O121505B_	8.5	18.5	26.5	22.5	FKP1R021505F_
0.022 "	8.5	18.5	26.5	22.5	FKP1O122205F_	10.5	20.5	26.5	22.5	FKP1R022205H_
0.033 "	10.5	20.5	26.5	22.5	FKP1O123305H_	11	21	31.5	27.5	FKP1R023306B_
	9	19	31.5	27.5	FKP1O123306A_	9	19	41.5	37.5	FKP1R023307A_
0.047 "	11	21	31.5	27.5	FKP1O124706B_	13	24	31.5	27.5	FKP1R024706D_
						11	22	41.5	37.5	FKP1R024707B_
0.068 "	13	24	31.5	27.5	FKP1O126806D_	11	22	41.5	37.5	FKP1R026807B_
	11	22	41.5	37.5	FKP1O126807B_					
0.1 µF	13	24	41.5	37.5	FKP1O131007C_	15	26	41.5	37.5	FKP1R031007D_
0.15 "	15	26	41.5	37.5	FKP1O131507D_	17	29	41.5	37.5	FKP1R031507E_
0.22 "	19	32	41.5	37.5	FKP1O132207F_	19	32	41.5	37.5	FKP1R032207F_
0.33 "	20	39.5	41.5	37.5	FKP1O133307G_	24	45.5	41.5	37.5	FKP1R033307H_
0.47 "	31	46	41.5	37.5	FKP1O134707I_	31	46	41.5	37.5	FKP1R034707I_
0.68 "	35	50	41.5	37.5	FKP1O136807J_	40	55	41.5	37.5	FKP1R036807K_
1.0 µF	40	55	41.5	37.5	FKP1O141007K_	35	50	57	52.5	FKP1R041009F_
	35	50	57	52.5	FKP1O141009F_					
1.5 "	45	55	57	52.5	FKP1O141509H_	45	65	57	52.5	FKP1R041509J_
2.2 "	45	65	57	52.5	FKP1O142209J_					

* AC voltages: $f \leq 1000 \text{ Hz}$; $1.4 \times U_{\text{rms}} + \text{UDC} \leq U_r$

New values

** PCM = Printed circuit module = pin spacing

Dims. in mm.

Ionisation inception level in isolated cases may be lower than admissible rated AC voltage.

Part number completion:	
Version code:	2-pin = 00
	4-pin = D4
Tolerance:	20 % = M
	10 % = K
	5 % = J
Packing:	bulk = S
Pin length:	6-2 = SD
Taped version see page 145.	

2-pin version

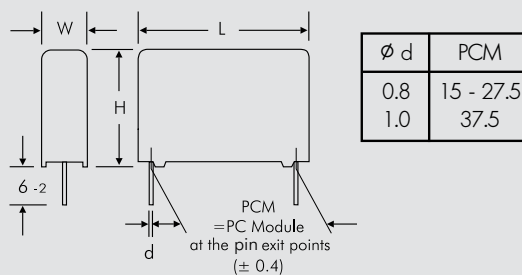

4-pin version

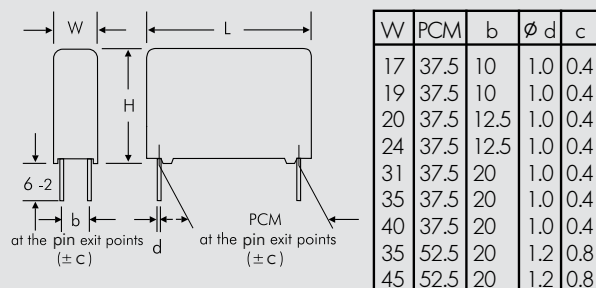

Rights reserved to amend design data without prior notification.

Continuation page 73

Continuation

General Data

Capacitance	1600 VDC/650 VAC*					2000 VDC/700 VAC*				
	W	H	L	PCM**	Part number	W	H	L	PCM**	Part number
100 pF	5	11	18	15	FKP1T001004B_-----	5	11	18	15	FKP1U001004B_-----
150 "	5	11	18	15	FKP1T001504B_-----	5	11	18	15	FKP1U001504B_-----
220 "	5	11	18	15	FKP1T002204B_-----	5	11	18	15	FKP1U002204B_-----
330 "	5	11	18	15	FKP1T003304B_-----	6	12.5	18	15	FKP1U003304C_-----
470 "	5	11	18	15	FKP1T004704B_-----	6	12.5	18	15	FKP1U004704C_-----
680 "	5	11	18	15	FKP1T006804B_-----	6	12.5	18	15	FKP1U006804C_-----
1000 pF	6	12.5	18	15	FKP1T011004C_-----	7	14	18	15	FKP1U011004D_-----
	5	14	26.5	22.5	FKP1T011005A_-----	5	14	26.5	22.5	FKP1U011005A_-----
1500 "	7	14	18	15	FKP1T011504D_-----	6	15	26.5	22.5	FKP1U011505B_-----
	5	14	26.5	22.5	FKP1T011505A_-----					
2200 "	8	15	18	15	FKP1T012204F_-----	7	16.5	26.5	22.5	FKP1U012205D_-----
	5	14	26.5	22.5	FKP1T012205A_-----					
3300 "	6	15	26.5	22.5	FKP1T013305B_-----	7	16.5	26.5	22.5	FKP1U013305D_-----
4700 "	7	16.5	26.5	22.5	FKP1T014705D_-----	8.5	18.5	26.5	22.5	FKP1U014705F_-----
6800 "	8.5	18.5	26.5	22.5	FKP1T016805F_-----	10.5	20.5	26.5	22.5	FKP1U016805H_-----
0.01 µF	10.5	20.5	26.5	22.5	FKP1T021005H_-----	11	21	31.5	27.5	FKP1U021006B_-----
0.015 "	11	21	31.5	27.5	FKP1T021506B_-----	13	24	31.5	27.5	FKP1U021506D_-----
0.022 "	11	21	31.5	27.5	FKP1T022206B_-----	15	26	31.5	27.5	FKP1U022206F_-----
						13	24	41.5	37.5	FKP1U022207C_-----
0.033 "	13	24	31.5	27.5	FKP1T023306D_-----	13	24	41.5	37.5	FKP1U023307C_-----
	13	24	41.5	37.5	FKP1T023307C_-----					
0.047 "	13	24	41.5	37.5	FKP1T024707C_-----	17	29	41.5	37.5	FKP1U024707E_-----
0.068 "	15	26	41.5	37.5	FKP1T026807D_-----	19	32	41.5	37.5	FKP1U026807F_-----
0.1 µF	17	29	41.5	37.5	FKP1T031007E_-----	20	39.5	41.5	37.5	FKP1U031007G_-----
0.15 "	20	39.5	41.5	37.5	FKP1T031507G_-----	24	45.5	41.5	37.5	FKP1U031507H_-----
0.22 "	24	45.5	41.5	37.5	FKP1T032207H_-----	35	50	41.5	37.5	FKP1U032207J_-----
0.33 "	31	46	41.5	37.5	FKP1T033307I_-----	40	55	41.5	37.5	FKP1U033307K_-----
0.47 "	40	55	41.5	37.5	FKP1T034707K_-----	45	55	57	52.5	FKP1U034709H_-----
0.68 "	35	50	57	52.5	FKP1T036809F_-----	45	65	57	52.5	FKP1U036809J_-----
1.0 µF	45	55	57	52.5	FKP1T041009H_-----					

* AC voltages: $f \leq 1000 \text{ Hz}$; $1.4 \times U_{\text{rms}} + \text{UDC} \leq U_r$

■ New values

** PCM = Printed circuit module = pin spacing

Dims. in mm.

Ionisation inception level in isolated cases may be lower than admissible rated AC voltage.

Part number completion:

Version code:	2-pin	= 00
	4-pin	= D4
Tolerance:	20 %	= M
	10 %	= K
	5 %	= J
Packing:	bulk	= S
Pin length:	6-2	= SD
Taped version see page 145.		

2-pin version

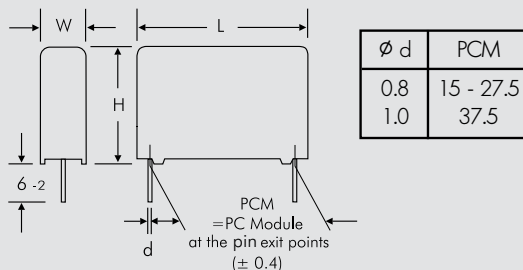

4-pin version

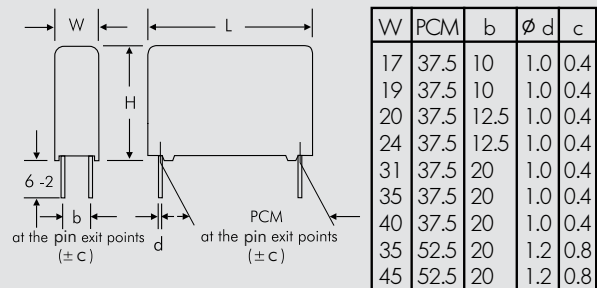

Rights reserved to amend design data without prior notification.

Continuation page 74

Continuation

General Data

Capacitance	4000 VDC/700 VAC*					6000 VDC/700 VAC*				
	W	H	L	PCM**	Part number	W	H	L	PCM**	Part number
470 pF	5	14	26.5	22.5	FKP1X004705A	5	14	26.5	22.5	FKP1Y004705A
680 "	5	14	26.5	22.5	FKP1X006805A	5	14	26.5	22.5	FKP1Y006805A
1000 pF	5	14	26.5	22.5	FKP1X011005A	5	14	26.5	22.5	FKP1Y011005A
1500 "	7	16.5	26.5	22.5	FKP1X011505D	7	16.5	26.5	22.5	FKP1Y011505D
2200 "	8.5	18.5	26.5	22.5	FKP1X012205F	10.5	20.5	26.5	22.5	FKP1Y012205H
3300 "	10.5	20.5	26.5	22.5	FKP1X013305H	10.5	20.5	26.5	22.5	FKP1Y013305H
4700 "	11	21	31.5	27.5	FKP1X014706B	11	21	31.5	27.5	FKP1Y014706B
6800 "	13	24	31.5	27.5	FKP1X016806D	13	24	31.5	27.5	FKP1Y016806D
0.01 µF	15	26	31.5	27.5	FKP1X021006F	15	26	31.5	27.5	FKP1Y021006F
0.015 "	13	24	41.5	37.5	FKP1X021507C	13	24	41.5	37.5	FKP1Y021507C
0.022 "	17	29	41.5	37.5	FKP1X022207E	17	29	41.5	37.5	FKP1Y022207E
0.033 "	20	39.5	41.5	37.5	FKP1X023307G	20	39.5	41.5	37.5	FKP1Y023307G
0.047 "	24	45.5	41.5	37.5	FKP1X024707H	24	45.5	41.5	37.5	FKP1Y024707H
0.068 "	31	46	41.5	37.5	FKP1X026807I	31	46	41.5	37.5	FKP1Y026807I
0.1 µF	35	50	41.5	37.5	FKP1X031007J	35	50	41.5	37.5	FKP1Y031007J
0.15 "	40	55	41.5	37.5	FKP1X031507K	40	55	41.5	37.5	FKP1Y031507K
0.22 "	45	55	57	52.5	FKP1X032209H	45	55	57	52.5	FKP1Y032209H

* AC voltages: $f \leq 1000 \text{ Hz}$; $1.4 \times U_{\text{rms}} + \text{UDC} \leq U_r$

■ New values

** PCM = Printed circuit module = pin spacing

Dims. in mm.

Ionisation inception level in isolated cases may be lower than admissible rated AC voltage.

Rights reserved to amend design data without prior notification.

Part number completion:

Version code: 2-pin = 00
 4-pin = D4
 Tolerance: 20 % = M
 10 % = K
 5 % = J
 Packing: bulk = S
 Pin length: 6-2 = SD
 Taped version see page 145.

Permissible AC voltage in relation to frequency at 10° C internal temperature rise (general guide).

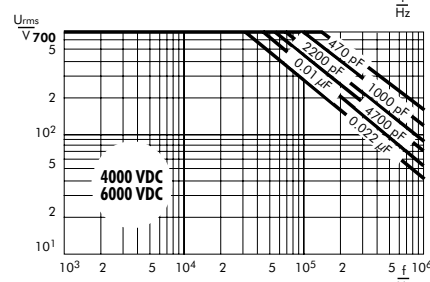
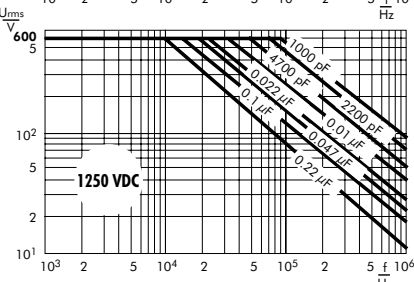
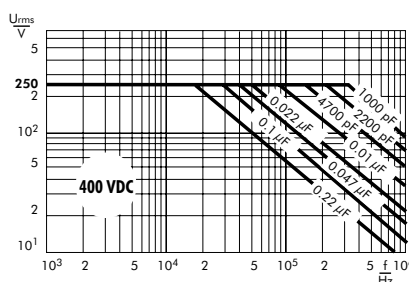
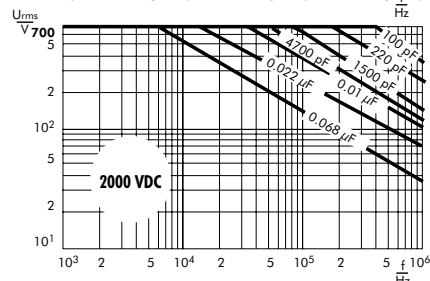
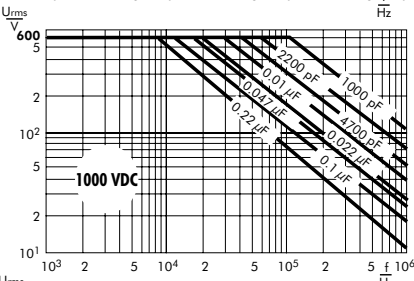
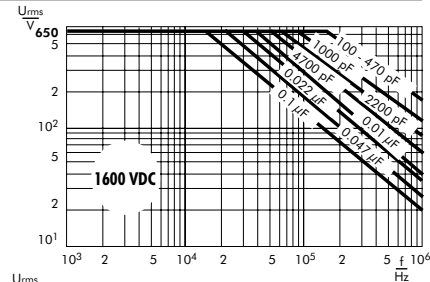
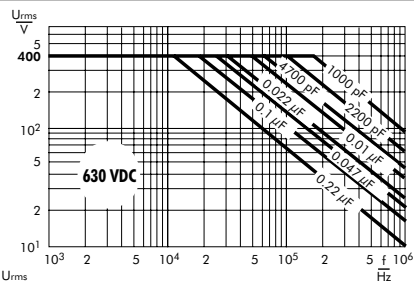

WIMA Radio Interference Suppression Capacitors for Overvoltage Protection



WIMA MKP-X2

WIMA MKP-X1 R

WIMA MKP-Y2

WIMA MP 3-X2

WIMA MP 3-X1

WIMA MP 3-Y2/3R-Y2

Depending on the application, radio interference suppression capacitors remain on the mains for an uninterrupted period of 10, 20 or more years. They need not only satisfy EMC requirements in suppressing outgoing interference from an application but they also have to protect the application from incoming power surges. Hence careful selection of these components is essential.

The special feature of WIMA Polypropylene RFI capacitors are the high capacitance values at smaller case sizes compared to metallized paper capacitors, being available with capacitances from 1000 pF through 10 μ F at AC voltages of 300 VAC, 305 VAC and 440 VAC for class X2, X1

and Y2. Based on the dielectric used they are highly cost-effective.

WIMA metallized paper capacitors are neither actively nor passively flammable. The components are resin impregnated under vacuum and encapsulated with self-extinguishing cast resin. Thanks to the good oxidation behaviour of the paper dielectric, they have outstanding self-healing properties even with high energy pulses. The capacitors are specified for temperatures up to 110° C and are available for class X1, X2 and Y2 applications.

Class X capacitors are connected between phase and neutral or phase and phase conductors. Class Y capacitors have an increased degree of electrical and mechanical safety and are connected, for example, between phase conductors and earthed casing, and thus by-pass operating insulation.

WIMA RFI capacitors with metallized paper dielectric are available with capacitances from 1000 pF through 1.0 μ F and voltage ratings of 250 VAC, 275 VAC, 300 VAC, 440 VAC and 500 VAC.

The specified rated AC voltage takes into account a rise of the mains voltage of up to 10% above the nominal value, in accordance with IEC 60384-14.

The components are environmentally compatible with the RoHS 2011/65/EU regulations of the European Union.



Metallized Polypropylene (PP) RFI-Capacitors Class X2 in PCM 7.5 mm to 37.5 mm. Capacitances from 1000 pF to 10 µF. Rated Voltage 305 VAC.

Special Features

- Reliable self-healing
- High degree of interference suppression due to good attenuation and low ESR
- According to RoHS 2011/65/EU

Typical Applications

Class X2 RFI applications to meet EMC regulations

- Capacitors connected to the mains between phase and neutral or phase conductors
- General requirements, pulse peak voltage ≤ 2.5 kV

Construction

Dielectric:

Polypropylene (PP) film

Capacitor electrodes:

Vacuum-deposited

Internal construction:

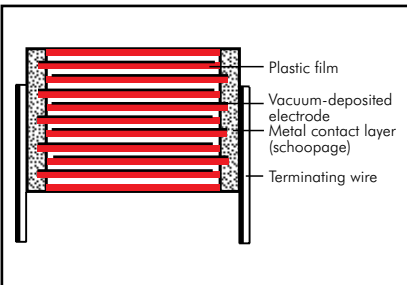

Encapsulation:

Solvent-resistant, flame-retardant plastic case with epoxy resin seal, UL 94 V-0

Terminations:

Tinned wire.

Marking:

Colour: Red. Marking: Black.

Electrical Data

Capacitance range: 1000 pF to 10 µF

Rated voltage: 305 VAC

Continuous DC voltage* (general guide): ≤ 560 V

Capacitance tolerances: $\pm 20\%$, $\pm 10\%$, $\pm 5\%$

Operating temperature range: -55°C to $+105^\circ\text{C}$

Climatic test category:

55/105/56 in accordance with IEC

Passive flammability class:

B for capacitors with $V > 1750$ mm³

C for capacitors with $V \leq 1750$ mm³

Test specifications:

In accordance with IEC 60384-14

Dissipation factors at $+20^\circ\text{C}$: $\tan \delta$

at f	$C \leq 0.1 \mu\text{F}$	$0.1 \mu\text{F} < C \leq 1.0 \mu\text{F}$	$C > 1.0 \mu\text{F}$
1 kHz	$\leq 15 \times 10^{-4}$	$\leq 20 \times 10^{-4}$	$\leq 30 \times 10^{-4}$
10 kHz	$\leq 20 \times 10^{-4}$	$\leq 60 \times 10^{-4}$	-
100 kHz	$\leq 100 \times 10^{-4}$	-	-

Insulation resistance at $+20^\circ\text{C}$:

$C \leq 0.33 \mu\text{F}$: $\geq 15 \times 10^3 \text{ M}\Omega$

$C > 0.33 \mu\text{F}$: $\geq 5000 \text{ sec (M}\Omega \times \mu\text{F)}$

Measuring voltage: 100 V/1 min.

Maximum pulse rise time:

100 V/ μsec for pulses equal to a voltage

amplitude with $\sqrt{2} \times 305 \text{ VAC} = 432 \text{ V}$

according to IEC 60384-14

Test voltage:

$C \leq 1.0 \mu\text{F}$: 2260 VDC, 2 sec.

$C > 1.0 \mu\text{F}$: 1800 VDC, 2 sec.

Reliability:

Operational life $> 300\,000$ hours

Failure rate < 2 fit ($0.5 \times U_r$ and 40°C)

Approvals:

Country	Authority	Specification	Symbol	Approval-No.
Germany	VDE	IEC 60384-14/4		40003472
USA/Canada	UL	UL 60384-14 CAN/CSA-E60384-14		E 134915

Mechanical Tests

Pull test on pins: 10 N in direction of pins according to IEC 60068-2-21

Vibration: 6 hours at 10...2000 Hz and 0.75 mm displacement amplitude or 10 g in accordance with IEC 60068-2-6

Low air density: 1kPa = 10 mbar in accordance with IEC 60068-2-13

Bump test: 4000 bumps at 390 m/sec² in accordance with IEC 60068-2-29

* If safety-approved EMI suppression capacitors are operated with a DC voltage being above the specified AC voltage rating the given approvals are no longer valid (IEC 60384-14).

Furthermore the permissible pulse rise time du/dt (F_{max}) will be subject to a reduction according to

$$F_{\text{max}} = F_r \times \sqrt{2} \times \text{UAC} / \text{UDC}$$

if the DC operating voltage UDC is higher than $\sqrt{2} \times \text{UAC}$

Packing

Available taped and reeled up to and including case size 15 x 26 x 31.5 / PCM 27.5 mm.

Detailed taping information and graphs at the end of the catalogue.

For further details and graphs please refer to Technical Information.

Continuation

General Data

Capacitance	305 VAC*					Part number
	W	H	L	PCM**		
1000 pF	4	9	10	7.5	MKX2AW11002C00_____	
1200 "	4	9	10	7.5	MKX2AW11202C00_____	
1500 "	4	9	10	7.5	MKX2AW11502C00_____	
1800 "	4	9	10	7.5	MKX2AW11802C00_____	
2200 "	4	9	10	7.5	MKX2AW12202C00_____	
2700 "	4	9	10	7.5	MKX2AW12702C00_____	
3300 "	4	9	10	7.5	MKX2AW13302C00_____	
3900 "	4	9	10	7.5	MKX2AW13902C00_____	
4700 "	4	9	10	7.5	MKX2AW14702C00_____	
5600 "	4	9	10	7.5	MKX2AW15602C00_____	
6800 "	4	9	10	7.5	MKX2AW16802C00_____	
8200 "	4	9	10	7.5	MKX2AW18202C00_____	
0.01 µF	4	9	10	7.5	MKX2AW21002C00_____	
	5	11	13	10	MKX2AW21003F00_____	
0.012 "	4	9	10	7.5	MKX2AW21202C00_____	
	5	11	13	10	MKX2AW21203F00_____	
0.015 "	4	9	10	7.5	MKX2AW21502C00_____	
	5	11	13	10	MKX2AW21503F00_____	
0.018 "	4	9	10	7.5	MKX2AW21802C00_____	
	5	11	13	10	MKX2AW21803F00_____	
0.022 "	4	9	10	7.5	MKX2AW22202C00_____	
	5	11	13	10	MKX2AW22203F00_____	
0.027 "	5	10.5	10.3	7.5	MKX2AW22702E00_____	
	5	11	13	10	MKX2AW22703F00_____	
0.033 "	5	10.5	10.3	7.5	MKX2AW23302E00_____	
	5	11	13	10	MKX2AW23303F00_____	
0.039 "	5.7	12.5	10.3	7.5	MKX2AW23902F00_____	
	5	11	13	10	MKX2AW23903F00_____	
0.047 "	5.7	12.5	10.3	7.5	MKX2AW24702F00_____	
	6	12.5	13	10	MKX2AW24703H00_____	
	5	11	18	15	MKX2AW24704B00_____	
0.056 "	6	12.5	13	10	MKX2AW25603H00_____	
	5	11	18	15	MKX2AW25604B00_____	
0.068 "	6	12.5	13	10	MKX2AW26803H00_____	
	5	11	18	15	MKX2AW26804B00_____	
0.082 "	6	12.5	13	10	MKX2AW28203H00_____	
	5	11	18	15	MKX2AW28204B00_____	

* f = 50/60 Hz

** PCM = Printed circuit module = pin spacing

Dims. in mm.

d = 0.6 ϕ if PCM < 15
d = 0.8 ϕ if PCM \geq 15

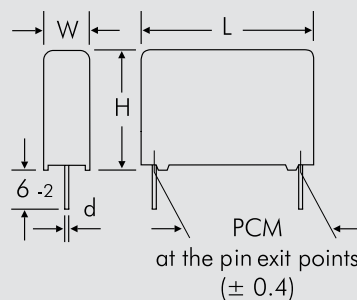

Part number completion:	
Tolerance:	20 % = M
	10 % = K
	5 % = J
Packing:	bulk = S
Pin length:	6-2 = SD
Taped version see page 145.	

Rights reserved to amend design data without prior notification.

Continuation

General Data

Capacitance	305 VAC*					Part number
	W	H	L	PCM**		
0.1 μ F	8	12	13	10	MKX2AW31003I00_____	
	5	11	18	15	MKX2AW31004B00_____	
	6	12.5	18	15	MKX2AW31004C00_____	
0.12 "	6	12.5	18	15	MKX2AW31204C00_____	
	6	12.5	18	15	MKX2AW31504C00_____	
0.15 "	8	15	18	15	MKX2AW31504F00_____	
	6	15	26.5	22.5	MKX2AW31505B00_____	
	8	15	18	15	MKX2AW31804F00_____	
0.18 "	6	15	26.5	22.5	MKX2AW31805B00_____	
	9	14	18	15	MKX2AW32204H00_____	
0.22 "	8	15	18	15	MKX2AW32204F00_____	
	6	15	26.5	22.5	MKX2AW32205B00_____	
0.27 "	8	15	18	15	MKX2AW32704F00_____	
	7	16.5	26.5	22.5	MKX2AW32705D00_____	
0.33 "	11	14	18	15	MKX2AW33304M00_____	
	9	16	18	15	MKX2AW33304J00_____	
	7	16.5	26.5	22.5	MKX2AW33305D00_____	
0.39 "	8.5	18.5	26.5	22.5	MKX2AW33905F00_____	
0.47 "	8.5	18.5	26.5	22.5	MKX2AW34705F00_____	
	10.5	19	26.5	22.5	MKX2AW34705G00_____	
	9	19	31.5	27.5	MKX2AW34706A00_____	
0.56 "	10.5	19	26.5	22.5	MKX2AW35605G00_____	
	9	19	31.5	27.5	MKX2AW35606A00_____	
0.68 "	10.5	19	26.5	22.5	MKX2AW36805G00_____	
	11	21	26.5	22.5	MKX2AW36805I00_____	
	9	19	31.5	27.5	MKX2AW36806A00_____	
0.82 "	11	21	26.5	27.5	MKX2AW38205I00_____	
	9	19	31.5	27.5	MKX2AW38206A00_____	

* f = 50/60 Hz

** PCM = Printed circuit module = pin spacing

Dims. in mm.

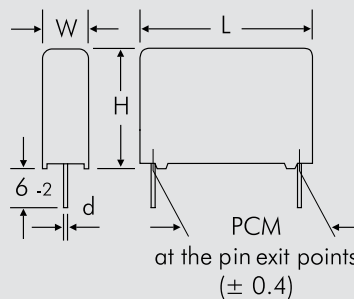

d = 0.6 ϕ if PCM = 10
d = 0.8 ϕ if PCM \geq 15

Part number completion:

Tolerance: 20 % = M
10 % = K
5 % = J

Packing: bulk = S
Pin length: 6-2 = SD

Taped version see page 145.

Rights reserved to amend design data without prior notification.

Continuation page 79

Continuation

General Data

Capacitance	305 VAC*				PCM**	Part number
	W	H	L			
1.0 μ F	11	21	26.5	22.5	MKX2AW41005I00_____	
	11	21	31.5	27.5	MKX2AW41006B00_____	
	13	24	31.5	27.5	MKX2AW41006D00_____	
1.2 "	11	21	31.5	27.5	MKX2AW41206B00_____	
	13	24	31.5	27.5	MKX2AW41506D00_____	
1.5 "	15	26	31.5	27.5	MKX2AW41506F00_____	
	13	24	41.5	37.5	MKX2AW41507C00_____	
	13	24	31.5	27.5	MKX2AW41806D00_____	
1.8 "	13	24	41.5	37.5	MKX2AW41807C00_____	
	15	26	31.5	27.5	MKX2AW42206F00_____	
2.2 "	17	29	31.5	27.5	MKX2AW42206G00_____	
	13	24	41.5	37.5	MKX2AW42207C00_____	
	15	26	41.5	37.5	MKX2AW42207D00_____	
2.7 "	17	29	31.5	27.5	MKX2AW42706G00_____	
	15	26	41.5	37.5	MKX2AW42707D00_____	
	17	29	41.5	37.5	MKX2AW42707E00_____	
3.3 "	17	34.5	31.5	27.5	MKX2AW43306I00_____	
	20	39.5	31.5	27.5	MKX2AW43306J00_____	
	15	26	41.5	37.5	MKX2AW43307D00_____	
3.9 "	17	29	41.5	37.5	MKX2AW43307E00_____	
	17	34.5	31.5	27.5	MKX2AW43906I00_____	
	17	29	41.5	37.5	MKX2AW43907E00_____	
4.7 "	19	32	41.5	37.5	MKX2AW43907F00_____	
	20	39.5	31.5	27.5	MKX2AW44706J00_____	
	19	32	41.5	37.5	MKX2AW44707F00_____	
5.6 "	20	39.5	41.5	37.5	MKX2AW44707G00_____	
	19	32	41.5	37.5	MKX2AW45607F00_____	
	20	39.5	41.5	37.5	MKX2AW45607G00_____	
6.8 "	20	39.5	41.5	37.5	MKX2AW46807G00_____	
	24	45.5	41.5	37.5	MKX2AW46807H00_____	
8.2 "	24	45.5	41.5	37.5	MKX2AW48207H00_____	
	31	46	41.5	37.5	MKX2AW48207I00_____	
10 μ F	24	45.5	41.5	37.5	MKX2AW51007H00_____	
	31	46	41.5	37.5	MKX2AW51007I00_____	

* f = 50/60 Hz

** PCM = Printed circuit module = pin spacing

Dims. in mm.

d = 0.8 ϕ if PCM \leq 27.5
d = 1.0 ϕ if PCM = 37.5

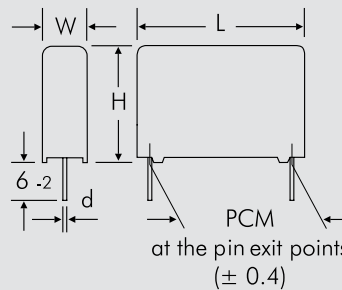

Part number completion:	
Tolerance:	20 % = M
	10 % = K
	5 % = J
Packing:	bulk = S
Pin length:	6-2 = SD
Taped version see page 145.	

Rights reserved to amend design data without prior notification.

Metallized Polypropylene (PP) RFI-Capacitors Class X1 with Internal Series Connection in PCM 10 mm to 37.5 mm. Capacitances from 1000 pF to 2.2 µF. Rated Voltage 440 VAC.

Special Features

- Reliable self-healing
- Increased corona inception level due to internal series connection
- High degree of interference suppression due to good attenuation and low ESR
- According to RoHS 2011/65/EU

Typical Applications

Class X1 RFI applications to meet EMC regulations

- Capacitors connected to the mains between phase and neutral or phase and phase conductors
- High peak voltage applications, pulse peak voltage ≤ 4 kV

Construction

Dielectric:

Polypropylene (PP) film

Capacitor electrodes:

Vacuum-deposited

Internal construction:

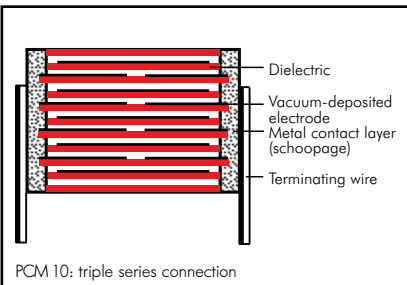

Encapsulation:

Solvent-resistant, flame-retardant plastic case with epoxy resin seal, UL 94 V-0

Terminations:

Tinned wire.

Marking:

Colour: Red. Marking: Black.

Electrical Data

Capacitance range: 1000 pF to 2.2 µF

Rated voltage: 440 VAC

Continuous DC voltage* (general guide): ≤ 1000 V

Capacitance tolerances:

$\pm 20\%$, $\pm 10\%$, $\pm 5\%$

Operating temperature range:

-55°C to $+105^\circ\text{C}$

Climatic test category:

55/105/56 in accordance with IEC

Passive flammability class:

B for capacitors with $V > 1750$ mm³

C for capacitors with $V \leq 1750$ mm³

Test specifications:

In accordance with IEC 60384-14

Dissipation factors at $+20^\circ\text{C}$: $\tan \delta$

at f	$C \leq 0.1 \mu\text{F}$	$0.1 \mu\text{F} < C \leq 1.0 \mu\text{F}$	$C > 1.0 \mu\text{F}$
1 kHz	$\leq 15 \times 10^{-4}$	$\leq 20 \times 10^{-4}$	$\leq 30 \times 10^{-4}$
10 kHz	$\leq 20 \times 10^{-4}$	$\leq 60 \times 10^{-4}$	-
100 kHz	$\leq 100 \times 10^{-4}$	-	-

Insulation resistance at $+20^\circ\text{C}$:

$C \leq 0.33 \mu\text{F}$: $\geq 15 \times 10^3 \text{ M}\Omega$

$C > 0.33 \mu\text{F}$: $\geq 5000 \text{ sec (M}\Omega \times \mu\text{F)}$

Measuring voltage: 100 V/1 min.

Maximum pulse rise time:

100 V/ μsec for pulses equal to a voltage

amplitude with $\sqrt{2} \times 440 \text{ VAC} = 623 \text{ V}$

according to IEC 60384-14

Test voltage:

$C \leq 1.0 \mu\text{F}$: 2260 VDC, 2sec.



$C > 1.0 \mu\text{F}$: 1900 VDC, 2sec.

Reliability:

Operational life $> 300\,000$ hours

Failure rate < 2 fit ($0.5 \times U_r$ and 40°C)

Approvals:

Country	Authority	Specification	Symbol	Approval-No.
Germany	VDE	IEC 60384-14/4		40041297
USA/Canada	UL	UL 60384-14 CAN/CSA-E60384-14		E 134915

Mechanical Tests

Pull test on pins: 10 N in direction of pins according to IEC 60068-2-21

Vibration: 6 hours at 10...2000 Hz and 0.75 mm displacement amplitude or 10 g in accordance with IEC 60068-2-6

Low air density: 1kPa = 10 mbar in accordance with IEC 60068-2-13

Bump test: 4000 bumps at 390 m/sec² in accordance with IEC 60068-2-29

* If safety-approved EMI suppression capacitors are operated with a DC voltage being above the specified AC voltage rating the given approvals are no longer valid (IEC 60384-14).

Furthermore the permissible pulse rise time du/dt (F_{max}) will be subject to a reduction according to

$$F_{\text{max}} = F_r \times \sqrt{2} \times \text{UAC} / \text{UDC}$$

if the DC operating voltage UDC is higher than $\sqrt{2} \times \text{UAC}$

Packing

Available taped and reeled up to and including case size 15 x 26 x 31.5 / PCM 27.5 mm.

Detailed taping information and graphs at the end of the catalogue.

For further details and graphs please refer to Technical Information.

Continuation

General Data

Capacitance	440 VAC*				PCM**	Part number
	W	H	L			
1000 pF	4	9.5	13		10	MKX14W11003D00_____
1200 "	4	9.5	13		10	MKX14W11203D00_____
1500 "	4	9.5	13		10	MKX14W11503D00_____
1800 "	4	9.5	13		10	MKX14W11803D00_____
2200 "	4	9.5	13		10	MKX14W12203D00_____
2700 "	4	9.5	13		10	MKX14W12703D00_____
3300 "	4	9.5	13		10	MKX14W13303D00_____
3900 "	4	9.5	13		10	MKX14W13903D00_____
4700 "	5	11	13		10	MKX14W14703F00_____
5600 "	5	11	13		10	MKX14W15603F00_____
6800 "	6	12.5	13		10	MKX14W16803H00_____
	5	11	18		15	MKX14W16804B00_____
8200 "	6	12.5	13		10	MKX14W18203H00_____
	5	11	18		15	MKX14W18204B00_____
0.01 µF	8	12	13		10	MKX14W21003I00_____
	5	11	18		15	MKX14W21004B00_____
0.012 "	5	11	18		15	MKX14W21204B00_____
0.015 "	5	11	18		15	MKX14W21504B00_____
0.018 "	5	11	18		15	MKX14W21804B00_____
0.022 "	6	12.5	18		15	MKX14W22204C00_____
0.027 "	6	12.5	18		15	MKX14W22704C00_____
0.033 "	8	15	18		15	MKX14W23304F00_____
0.039 "	8	15	18		15	MKX14W23904F00_____
0.047 "	8	15	18		15	MKX14W24704F00_____
0.056 "	8	15	18		15	MKX14W25604F00_____
0.068 "	9	16	18		15	MKX14W26804J00_____
	6	15	26.5		22.5	MKX14W26805B00_____
0.082 "	7	16.5	26.5		22.5	MKX14W28205D00_____

* f = 50/60 Hz

** PCM = Printed circuit module = pin spacing

Dims. in mm.

d = 0.6 ø if PCM = 10
d = 0.8 ø if PCM = 15 - 22.5

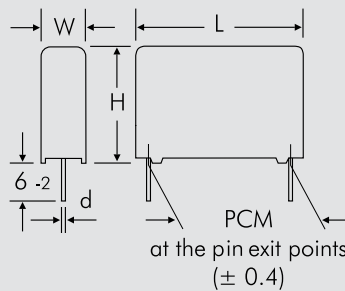

Part number completion:	
Tolerance:	20 % = M
	10 % = K
	5 % = J
Packing:	bulk = S
Pin length:	6-2 = SD
Taped version see page 145.	

Rights reserved to amend design data without prior notification.

Continuation page 82

Continuation

General Data

Capacitance	440 VAC*				PCM**	Part number
	W	H	L			
0.1 μ F	6	15	26.5		22.5	MKX14W31005B00_____
	7	16.5	26.5		22.5	MKX14W31005D00_____
0.12 "	7	16.5	26.5		22.5	MKX14W31205D00_____
	8.5	18.5	26.5		22.5	MKX14W31205F00_____
0.15 "	7	16.5	26.5		22.5	MKX14W31505D00_____
	8.5	18.5	26.5		22.5	MKX14W31505F00_____
0.18 "	9	19	31.5		27.5	MKX14W31506A00_____
	8.5	18.5	26.5		22.5	MKX14W31805F00_____
	10.5	19	26.5		22.5	MKX14W31805G00_____
0.22 "	9	19	31.5		27.5	MKX14W31806A00_____
	8.5	18.5	26.5		22.5	MKX14W32205F00_____
	11	21	26.5		22.5	MKX14W32205I00_____
0.27 "	9	19	31.5		27.5	MKX14W32206A00_____
	10.5	19	26.5		22.5	MKX14W32705G00_____
	9	19	31.5		27.5	MKX14W32706A00_____
0.33 "	11	21	31.5		27.5	MKX14W32706B00_____
	11	21	26.5		22.5	MKX14W33305I00_____
	9	19	31.5		27.5	MKX14W33306A00_____
0.39 "	11	21	31.5		27.5	MKX14W33306B00_____
	13	24	41.5		37.5	MKX14W33307C00_____
	11	21	31.5		27.5	MKX14W33906B00_____
	13	24	31.5		27.5	MKX14W33906D00_____
0.47 "	13	24	41.5		37.5	MKX14W33907C00_____
	11	21	31.5		27.5	MKX14W34706B00_____
	15	26	31.5		27.5	MKX14W34706F00_____
0.56 "	13	24	41.5		37.5	MKX14W34707C00_____
	13	24	31.5		27.5	MKX14W35606D00_____
	15	26	31.5		27.5	MKX14W35606F00_____
	13	24	41.5		37.5	MKX14W35607C00_____
0.68 "	15	26	41.5		37.5	MKX14W35607D00_____
	15	26	31.5		27.5	MKX14W36806F00_____
	17	29	31.5		27.5	MKX14W36806G00_____
	13	24	41.5		37.5	MKX14W36807C00_____
0.82 "	15	26	41.5		37.5	MKX14W36807D00_____
	17	29	41.5		37.5	MKX14W36807E00_____
	15	26	31.5		27.5	MKX14W38206F00_____
	17	34.5	31.5		27.5	MKX14W38206I00_____
	13	24	41.5		37.5	MKX14W38207C00_____
	17	29	41.5		37.5	MKX14W38207E00_____
	19	32	41.5		37.5	MKX14W38207F00_____

* f = 50/60 Hz

** PCM = Printed circuit module = pin spacing

Dims. in mm.

d = 0.8 ϕ if PCM \leq 27.5
d = 1.0 ϕ if PCM = 37.5

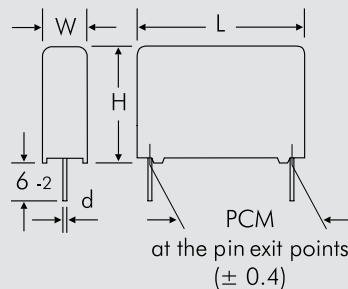

Part number completion:

Tolerance: 20 % = M
10 % = K
5 % = J

Packing: bulk = S
Pin length: 6-2 = SD

Taped version see page 145.

Rights reserved to amend design data without prior notification.

Continuation

General Data

Capacitance	440 VAC*				PCM**	Part number
	W	H	L			
1.0 μ F	17	29	31.5		27.5	MKX14W41006G00_____
	20	39.5	31.5		27.5	MKX14W41006J00_____
	15	26	41.5		37.5	MKX14W41007D00_____
	17	29	41.5		37.5	MKX14W41007E00_____
	20	39.5	41.5		37.5	MKX14W41007G00_____
1.2 "	17	34.5	31.5		27.5	MKX14W41206I00_____
	17	29	41.5		37.5	MKX14W41207E00_____
1.5 "	20	39.5	31.5		27.5	MKX14W41506J00_____
	19	32	41.5		37.5	MKX14W41507F00_____
1.8 "	19	32	41.5		37.5	MKX14W41807F00_____
2.2 "	20	39.5	41.5		37.5	MKX14W42207G00_____

* f = 50/60 Hz

** PCM = Printed circuit module = pin spacing

Dims. in mm.

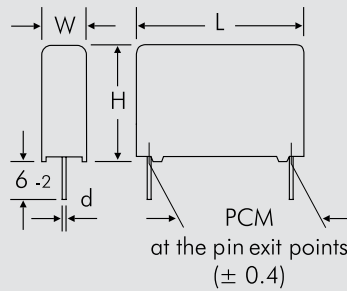

Part number completion:	
Tolerance:	20 % = M
	10 % = K
	5 % = J
Packing:	bulk = S
Pin length:	6-2 = SD
Taped version see page 145.	

d = 0.8 \varnothing if PCM = 27.5
d = 1.0 \varnothing if PCM = 37.5

Rights reserved to amend design data without prior notification.

Metallized Polypropylene (PP) RFI-Capacitors Class Y2 in PCM 10 mm to 37.5 mm. Capacitances from 1000 pF to 1.0 μF. Rated Voltage 300 VAC.

Special Features

- Reliable self-healing
- High degree of interference suppression due to good attenuation and low ESR
- According to RoHS 2011/65/EU

Typical Applications

Class Y2 RFI applications to meet EMC regulations

- Capacitors connected to the mains between phase or neutral and earthed casing
- By-passing of the basic or supplementary insulation, pulse peak voltage ≤ 5 kV

Construction

Dielectric:

Polypropylene (PP) film

Capacitor electrodes:

Vacuum-deposited

Internal construction:

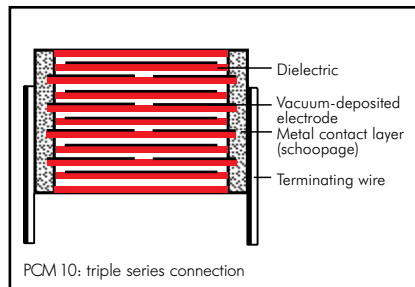

Encapsulation:

Solvent-resistant, flame-retardant plastic case with epoxy resin seal, UL 94 V-0

Terminations:

Tinned wire.

Marking:

Colour: Red. Marking: Black.

Electrical Data

Capacitance range: 1000 pF to 1.0 μF

Rated voltage: 300 VAC

Continuous DC voltage* (general guide): ≤ 1000 V

Capacitance tolerances:

$\pm 20\%$, $\pm 10\%$, $\pm 5\%$

Operating temperature range:

-55°C to $+105^\circ\text{C}$

Climatic test category:

55/105/56 in accordance with IEC

Passive flammability class:

B for capacitors with $V > 1750$ mm³

C for capacitors with $V \leq 1750$ mm³

Dissipation factors at $+20^\circ\text{C}$: $\tan \delta$

at f	$C \leq 0.1 \mu\text{F}$	$0.1 \mu\text{F} < C \leq 1.0 \mu\text{F}$
1 kHz	$\leq 15 \times 10^{-4}$	$\leq 20 \times 10^{-4}$
10 kHz	$\leq 20 \times 10^{-4}$	$\leq 60 \times 10^{-4}$
100 kHz	$\leq 100 \times 10^{-4}$	-

Insulation resistance at $+20^\circ\text{C}$:

$C \leq 0.33 \mu\text{F}$: $\geq 15 \times 10^3 \text{ M}\Omega$

$C > 0.33 \mu\text{F}$: $\geq 5000 \text{ sec (M}\Omega \times \mu\text{F)}$

Measuring voltage: 100 V/1 min.

Test specifications:

In accordance with IEC 60384-14

Maximum pulse rise time:

100 V/μsec for pulses equal to a voltage

amplitude with $\sqrt{2} \times 300 \text{ VAC} = 425 \text{ V}$

according to IEC 60384-14

Test voltage: 2700 VDC, 2 sec.

Reliability:

Operational life $> 300\,000$ hours

Failure rate < 2 fit ($0.5 \times U_r$ and 40°C)

Approvals:

Country	Authority	Specification	Symbol	Approval-No.
Germany	VDE	IEC 60384-14/4		40008997
USA/Canada	UL	UL 60384-14 CAN/CSA-E60384-14		E 134915

Mechanical Tests

Pull test on pins: 10 N in direction of pins according to IEC 60068-2-21

Vibration: 6 hours at 10...2000 Hz and 0.75 mm displacement amplitude or 10 g in accordance with IEC 60068-2-6

Low air density: 1 kPa = 10 mbar in accordance with IEC 60068-2-13

Bump test: 4000 bumps at 390 m/sec² in accordance with IEC 60068-2-29

Packing

Available taped and reeled.

Detailed taping information and graphs at the end of the catalogue.

* If safety-approved EMI suppression capacitors are operated with a DC voltage being above the specified AC voltage rating the given approvals are no longer valid (IEC 60384-14).

Furthermore the permissible pulse rise time du/dt (F_{max}) will be subject to a reduction according to

$$F_{\text{max}} = F_r \times \sqrt{2} \times \text{UAC} / \text{UDC}$$

if the DC operating voltage UDC is higher than $\sqrt{2} \times \text{UAC}$

For further details and graphs please refer to Technical Information.

Continuation

General Data

Capacitance	300 VAC*				PCM**	Part number
	W	H	L			
1000 pF	4	9.5	13		10	MKY22W11003D00_____
1200 "	4	9.5	13		10	MKY22W11203D00_____
1500 "	4	9.5	13		10	MKY22W11503D00_____
1800 "	4	9.5	13		10	MKY22W11803D00_____
2200 "	4	9.5	13		10	MKY22W12203D00_____
2700 "	4	9.5	13		10	MKY22W12703D00_____
3300 "	4	9.5	13		10	MKY22W13303D00_____
3900 "	4	9.5	13		10	MKY22W13903D00_____
4700 "	5	11	13		10	MKY22W14703F00_____
5600 "	5	11	13		10	MKY22W15603F00_____
6800 "	6	12.5	13		10	MKY22W16803H00_____
	5	11	18		15	MKY22W16804B00_____
8200 "	6	12.5	13		10	MKY22W18203H00_____
	5	11	18		15	MKY22W18204B00_____
0.01 µF	8	12	13		10	MKY22W21003I00_____
	5	11	18		15	MKY22W21004B00_____
0.012 "	5	11	18		15	MKY22W21204B00_____
0.015 "	5	11	18		15	MKY22W21504B00_____
0.018 "	5	11	18		15	MKY22W21804B00_____
0.022 "	6	12.5	18		15	MKY22W22204C00_____
0.027 "	6	12.5	18		15	MKY22W22704C00_____
0.033 "	8	15	18		15	MKY22W23304F00_____
0.039 "	8	15	18		15	MKY22W23904F00_____
0.047 "	8	15	18		15	MKY22W24704F00_____
0.056 "	8	15	18		15	MKY22W25604F00_____
0.068 "	9	16	18		15	MKY22W26804J00_____
	6	15	26.5		22.5	MKY22W26805B00_____
0.082 "	7	16.5	26.5		22.5	MKY22W28205D00_____

* f = 50/60 Hz

** PCM = Printed circuit module = pin spacing

Dims. in mm.

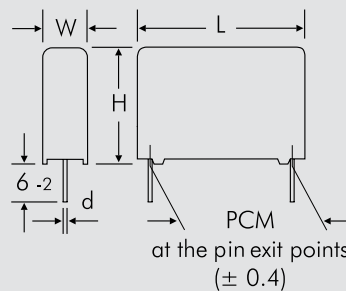

d = 0.6 ϕ if PCM = 10
d = 0.8 ϕ if PCM = 15 - 22.5

Part number completion:	
Tolerance:	20 % = M
	10 % = K
	5 % = J
Packing:	bulk = S
Pin length:	6-2 = SD
Taped version see page 145.	

Rights reserved to amend design data without prior notification.

Continuation page 86

Continuation

General Data

Capacitance	300 VAC*				PCM**	Part number
	W	H	L			
0.1 μ F	7	16.5	26.5		22.5	MKY22W31005D00_____
0.12 "	8.5	18.5	26.5		22.5	MKY22W31205F00_____
0.15 "	8.5	18.5	26.5		22.5	MKY22W31505F00_____
	9	19	31.5		27.5	MKY22W31506A00_____
0.18 "	10.5	19	26.5		22.5	MKY22W31805G00_____
	9	19	31.5		27.5	MKY22W31806A00_____
0.22 "	11	21	26.5		22.5	MKY22W32205I00_____
	9	19	31.5		27.5	MKY22W32206A00_____
0.27 "	11	21	31.5		27.5	MKY22W32706B00_____
0.33 "	11	21	31.5		27.5	MKY22W33306B00_____
	13	24	41.5		37.5	MKY22W33307C00_____
0.39 "	13	24	31.5		27.5	MKY22W33906D00_____
	13	24	41.5		37.5	MKY22W33907C00_____
0.47 "	15	26	31.5		27.5	MKY22W34706F00_____
	13	24	41.5		37.5	MKY22W34707C00_____
0.56 "	15	26	31.5		27.5	MKY22W35606F00_____
	13	24	41.5		37.5	MKY22W35607C00_____
	15	26	41.5		37.5	MKY22W35607D00_____
0.68 "	17	29	31.5		27.5	MKY22W36806G00_____
	15	26	41.5		37.5	MKY22W36807D00_____
	17	29	41.5		37.5	MKY22W36807E00_____
0.82 "	17	34.5	31.5		27.5	MKY22W38206I00_____
	17	29	41.5		37.5	MKY22W38207E00_____
	19	32	41.5		37.5	MKY22W38207F00_____
1.0 μ F	20	39.5	31.5		27.5	MKY22W41006J00_____
	17	29	41.5		37.5	MKY22W41007E00_____
	20	39.5	41.5		37.5	MKY22W41007G00_____

* f = 50/60 Hz

** PCM = Printed circuit module = pin spacing

Dims. in mm.

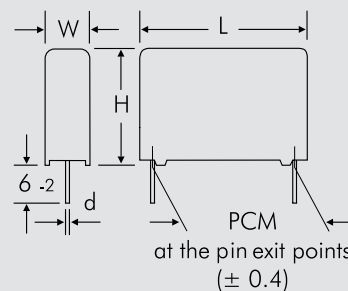

d = 0.8 \varnothing if PCM \leq 27.5
d = 1.0 \varnothing if PCM = 37.5

Part number completion:	
Tolerance:	20 % = M
	10 % = K
	5 % = J
Packing:	bulk = S
Pin length:	6-2 = SD
Taped version see page 145.	

Rights reserved to amend design data without prior notification.

Metallized Paper (MP) RFI-Capacitors Class X2
in PCM 10 mm to 27.5 mm. Capacitances from 1000 pF to 1.0 μF.
Rated Voltages 250 VAC and 275 VAC.

Special Features

- Particularly high reliability against active and passive flammability
- Excellent self-healing as well as high voltage strength
- High degree of interference suppression due to good attenuation and low ESR
- For temperatures up to +110° C
- According to RoHS 2011/65/EU

Typical Applications

Class X2 RFI applications to meet EMC regulations

- Capacitors connected to the mains between phase and neutral or phase and phase conductors
- General requirements, pulse peak voltage ≤ 2.5 kV

Construction

Dielectric:

Paper, epoxy resin impregnated

Capacitor electrodes:

Vacuum-deposited

Internal construction:

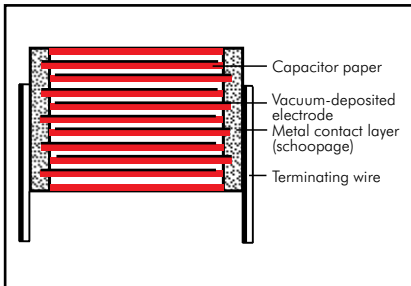

Encapsulation:

Self-extinguishing epoxy resin, UL 94 V-0, metal foil

Terminations:

Tinned wire.

Marking:

Marking: Black on Silver.

Electrical Data

Capacitance range:

1000 pF to 1.0 μF (E12-values on request)

Rated voltages: 250 VAC, 275 VAC

Continuous DC voltage* (general guide): ≤ 630 V

Capacitance tolerances: $\pm 20\%$

Operating temperature range:

-40° C to $+110^{\circ}$ C

Climatic test category:

40/110/56/C in accordance with IEC

Insulation resistance at $+20^{\circ}$ C:

$C \leq 0.33$ μF: $\geq 12 \times 10^3$ MΩ

$C > 0.33$ μF: ≥ 4000 sec (MΩ x μF)

Measuring voltage: 100 V/1 min.

Dissipation factors:

$\tan \delta \leq 13 \times 10^{-3}$ at 1 kHz and $+20^{\circ}$ C

Test specifications:

In accordance with IEC 60384-14

Approvals:

Country	Authority	Specification	Symbol	Approval-No.
Germany	VDE	IEC 60384-14		89749
USA/Canada	UL	UL 60384-14 CAN/CSA-E60384-14		E 100438

Maximum pulse rise time:

Capacitance pF/μF	Pulse rise time V/μsec max. operation
1000 ... 0.068	1500
0.1 ... 0.33	750
0.47	500
0.68 ... 1.0	250

for pulses equal to a voltage amplitude with $\sqrt{2} \times U_{AC} = 390$ V

according to IEC 60384-14

Test voltage: 1300 VDC, 2 sec.

Reliability:

Operational life $> 300\,000$ hours

Failure rate < 1 fit ($0.5 \times U_r$ and 40° C)

Mounting Recommendation

To minimize or avoid shock and/or vibration stresses to terminating wires and solder connections we recommend to fix voluminous resin-potted MP capacitors as from e.g. PCM 22.5 mm in an appropriate way since for constructional reasons they do not sit tight on the board.

* If safety-approved EMI suppression capacitors are operated with a DC voltage being above the specified AC voltage rating the given approvals are no longer valid (IEC 60384-14).

Furthermore the permissible pulse rise time du/dt ($F_{max.}$) will be subject to a reduction according to

$$F_{max.} = F_r \times \sqrt{2} \times U_{AC} / U_{DC}$$

if the DC operating voltage U_{DC} is higher than $\sqrt{2} \times U_{AC}$

Packing

Available taped and reeled up to and including PCM 22.5 mm.

Detailed taping information and graphs at the end of the catalogue.

For further details and graphs please refer to Technical Information.

Continuation

General Data

Capacitance	250 VAC*					275 VAC*				
	W	H	L	PCM**	Part number	W	H	L	PCM**	Part number
1000 pF	4	8.5	13.5	10	MPX20W1100FA00_	4	8.5	13.5	10	MPX21W1100FA00_
1500 „	4	8.5	13.5	10	MPX20W1150FA00_	4	8.5	13.5	10	MPX21W1150FA00_
2200 „	4	8.5	13.5	10	MPX20W1220FA00_	4	8.5	13.5	10	MPX21W1220FA00_
3300 „	4	8.5	13.5	10	MPX20W1330FA00_	4	8.5	13.5	10	MPX21W1330FA00_
4700 „	5	10	13.5	10	MPX20W1470FB00_	5	10	13.5	10	MPX21W1470FB00_
6800 „	5	13	19	15	MPX20W1680FC00_	5	13	19	15	MPX21W1680FC00_
0.01 µF	5	13	19	15	MPX20W2100FC00_	5	13	19	15	MPX21W2100FC00_
0.015 „	5	13	19	15	MPX20W2150FC00_	5	13	19	15	MPX21W2150FC00_
0.022 „	5	13	19	15	MPX20W2220FC00_	5	13	19	15	MPX21W2220FC00_
0.033 „	6	14	19	15	MPX20W2330FD00_	6	14	19	15	MPX21W2330FD00_
0.047 „	7	15	19	15	MPX20W2470FE00_	7	15	19	15	MPX21W2470FE00_
0.068 „	8	17	19	15	MPX20W2168FF00_	8	17	19	15	MPX21W2680FF00_
0.1 µF	10	18	19	15	MPX20W3100FG00_	10	18	19	15	MPX21W3100FG00_
	8	20	28	22.5	MPX20W3100FH00_	8	20	28	22.5	MPX21W3100FH00_
0.15 „	8	20	28	22.5	MPX20W3150FH00_	8	20	28	22.5	MPX21W3150FH00_
0.22 „	10	22	28	22.5	MPX20W3220FI00_	10	22	28	22.5	MPX21W3220FI00_
0.33 „	12	24	28	22.5	MPX20W3330FJ00_	12	24	28	22.5	MPX21W3330FJ00_
0.47 „	13	25	33	27.5	MPX20W3470FK00_	13	25	33	27.5	MPX21W3470FK00_
0.68 „	15	26	33	27.5	MPX20W3680FL00_	15	26	33	27.5	MPX21W3680FL00_
1.0 µF	20	32	33	27.5	MPX20W4100FM00_	20	32	33	27.5	MPX21W4100FM00_

* f = 50/60 Hz

** PCM = Printed circuit module = pin spacing

Upon request with long pins 35-2 mm max.

Dims. in mm.

Part number completion:

Tolerance: 20 % = M

Packing: bulk = S

Pin length: 6-2 = SD

Taped version see page 145.

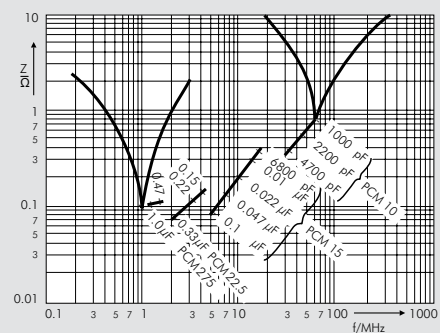
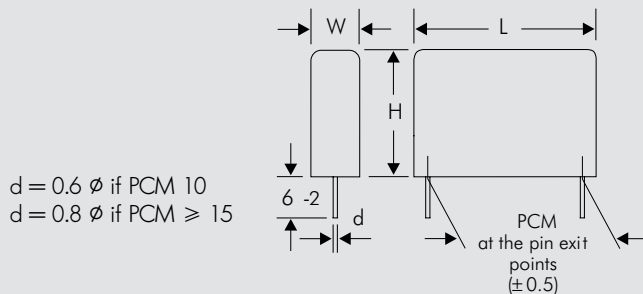

Impedance change with frequency
(general guide)

Rights reserved to amend design data without prior notification.

**Metallized Paper (MP) RFI-Capacitors Class X1
in PCM 10 mm to 27.5 mm. Capacitances from 1000 pF to 0.22 μF.
Rated Voltages from 300 VAC to 500 VAC.**

Special Features

- Particularly high reliability against active and passive flammability
- Excellent self-healing as well as high voltage strength
- High degree of interference suppression due to good attenuation and low ESR
- For temperatures up to +110° C
- According to RoHS 2011/65/EU

Typical Applications

Class X1 RFI applications to meet EMC regulations

- Capacitors connected to the mains between phase and neutral or phase and phase conductors
- High peak voltage applications, pulse peak voltage ≤ 4 kV

Construction

Dielectric:

Paper, epoxy resin impregnated

Capacitor electrodes:

Vacuum-deposited

Internal construction:

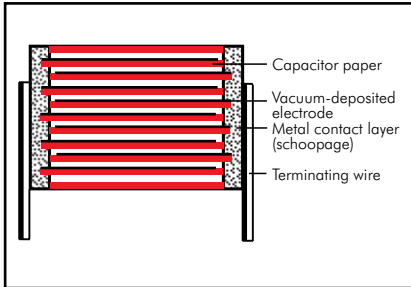

Encapsulation:

Self-extinguishing epoxy resin, UL 94 V-0, metal foil

Terminations:

Tinned wire.

Marking:

Marking: Black on Silver.

Electrical Data

Capacitance range:

1000 pF to 0.22 μF (E12-values on request)

Rated voltages:

300 VAC, 440 VAC, 500 VAC

Continuous DC voltage* (general guide):

≤ 730 V for 300 VAC

≤ 850 V for 440 VAC and 500 VAC

Capacitance tolerances: ±20%

Operating temperature range:

-40° C to +110° C

Climatic test category:

40/110/56/C in accordance with IEC

Insulation resistance at +20° C:

≥ 12 x 10³ MΩ

Measuring voltage:

100 V/1 min. for 300 VAC and 440 VAC

500 V/1 min. for 500 VAC

Dissipation factors:

tan δ ≤ 13 x 10⁻³ at 1 kHz and +20° C

Approvals:

Country	Authority	Specification	Symbol	Approval-No.
Germany	VDE	IEC 60384-14		101355 (440/500 VAC) 89748 (300 VAC)
USA/Canada	UL	UL 60384-14 CAN/CSA-E60384-14		E 100438 (300 VAC)

Test specifications:

In accordance with IEC 60384-14

Maximum pulse rise time:

Capacitance pF/μF	Pulse rise time V/μsec max. operation
1000 ... 4700	2500
6800 ... 0.022	1750
0.033 ... 0.15	750
0.22	500

for pulses equal to a voltage amplitude with $\sqrt{2} \times 300 \text{ VAC} = 425 \text{ V}$, with $\sqrt{2} \times 440 \text{ VAC} = 623 \text{ V}$, with $\sqrt{2} \times 500 \text{ VAC} = 707 \text{ V}$ according to IEC 60384-14

Test voltage: 2300 VDC, 2 sec.

Reliability:

Operational life > 300 000 hours

Failure rate < 1 fit (0.5 x U_r and 40° C)

Mounting Recommendation

To minimize or avoid shock and/or vibration stresses to terminating wires and solder connections we recommend to fix voluminous resin-potted MP capacitors as from e.g. PCM 22.5 mm in an appropriate way since for constructional reasons they do not sit tight on the board.

* If safety-approved EMI suppression capacitors are operated with a DC voltage being above the specified AC voltage rating the given approvals are no longer valid (IEC 60384-14).

Furthermore the permissible pulse rise time du/dt (F_{max.}) will be subject to a reduction according to

$$F_{\text{max.}} = F_r \times \sqrt{2} \times \text{UAC} / \text{UDC}$$

if the DC operating voltage UDC is higher than $\sqrt{2} \times \text{UAC}$

Packing

Available taped and reeled up to and including PCM 22.5 mm.

Detailed taping information and graphs at the end of the catalogue.

For further details and graphs please refer to Technical Information.

Continuation

General Data

Capacitance	300 VAC*					440 VAC*				
	W	H	L	PCM**	Part number	W	H	L	PCM**	Part number
1000 pF	4	8.5	13.5	10	MPX12W1100FA00_					
1500 "	4	8.5	13.5	10	MPX12W1150FA00_					
2200 "	4	8.5	13.5	10	MPX12W1220FA00_					
3300 "	4	8.5	13.5	10	MPX12W1330FA00_					
4700 "	5	10	13.5	10	MPX12W1470FB00_					
6800 "	5	13	19	15	MPX12W1680FC00_	5	13	19	15	MPX14W1680FC00_
0.01 µF	5	13	19	15	MPX12W2100FC00_	5	13	19	15	MPX14W2100FC00_
0.015 "	6	14	19	15	MPX12W2150FD00_	6	14	19	15	MPX14W2150FD00_
0.022 "	7	15	19	15	MPX12W2220FE00_	7	15	19	15	MPX14W2220FE00_
0.033 "	8	17	19	15	MPX12W2330FF00_	10	18	19	15	MPX14W2330FG00_
0.047 "	10	18	19	15	MPX12W2470FG00_					
0.068 "	8	20	28	22.5	MPX12W2680FH00_					
0.1 µF	10	22	28	22.5	MPX12W3100FI00_					
0.15 "	12	24	28	22.5	MPX12W3150FJ00_					
0.22 "	13	25	33	27.5	MPX12W3220FK00_					

Capacitance	500 VAC*				
	W	H	L	PCM**	Part number
6800 pF	5	13	19	15	MPX15W1680FC00_
0.01 µF	5	13	19	15	MPX15W2100FC00_
0.015 "	6	14	19	15	MPX15W2150FD00_
0.022 "	7	15	19	15	MPX15W2220FE00_
0.033 "	10	18	19	15	MPX15W2330FG00_

** PCM = Printed circuit module = pin spacing
Upon request with long pins 35-2 mm max.

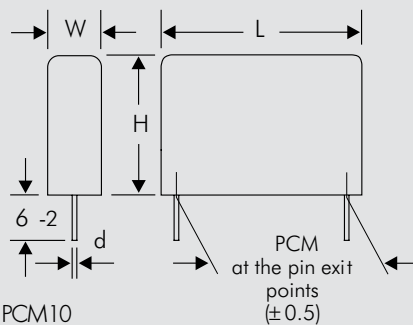

* f = 50/60 Hz

Dims in mm.

Rights reserved to amend design data without prior notification.

Part number completion:
Tolerance: 20 % = M
Packing: bulk = S
Pin length: 6-2 = SD
Taped version see page 145.

d = 0.6 φ if PCM10
d = 0.8 φ if PCM ≥ 15

Typical Graphs of the Capacitor Paper Dielectric

valid for:

MP 3-X2

MP 3-X1

MP 3-Y2 / 3R-Y2

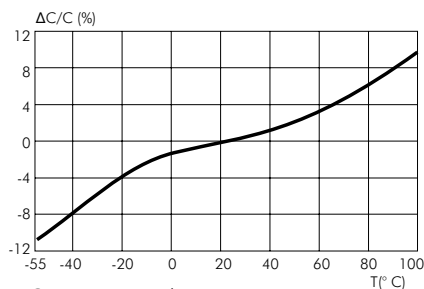

Capacitance change versus temperature (f=1 kHz) (general guide)

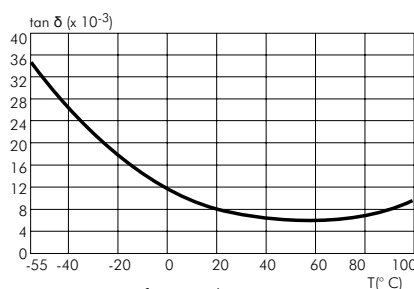

Dissipation factor change versus temperature (f=1 kHz) (general guide)

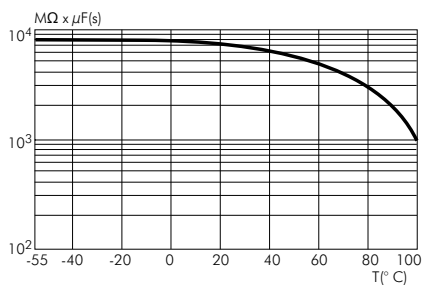

Insulation resistance change versus temperature (general guide)

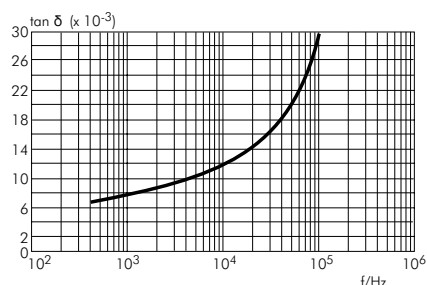

Dissipation factor change versus frequency (general guide)

WIMA MP 3-Y2 / 3R-Y2



**Metallized Paper (MP) RFI-Capacitors Class Y2
in PCM 10 mm to 27.5 mm. Capacitances from 1000 pF to 0.1 μF.
Rated Voltages 250 VAC and 300 VAC.**

Special Features

- Particularly high reliability against active and passive flammability
- Excellent self-healing as well as high voltage strength
- Twice the safety by internal series connection (300 VAC)
- High degree of interference suppression due to good attenuation and low ESR
- For temperatures up to +110° C
- According to RoHS 2011/65/EU

Typical Applications

Class Y2 RFI applications to meet EMC regulations

- Capacitors connected to the mains between phase or neutral and earthed casing
- By-passing of the basic or supplementary insulation, pulse peak voltage ≤ 5 kV

Construction

Dielectric:

Paper, epoxy resin impregnated

Capacitor electrodes:

Vacuum-deposited

Internal construction:

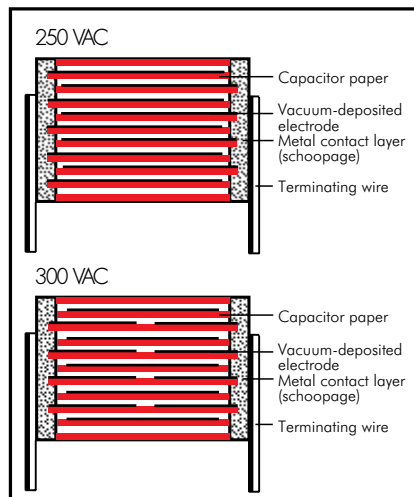

Encapsulation:

Self-extinguishing epoxy resin, UL 94 V-0, metal foil

Terminations:

Tinned wire.

Marking:

Marking: Black on Silver.

Electrical Data

Capacitance range:

1000 pF to 0.1 μF (E12-values on request)

Rated voltages:

250 VAC, 300 VAC

Continuous DC voltage* (general guide):

250 VAC: ≤ 1000 V

300 VAC: ≤ 1250 V

Capacitance tolerances: ±20%

Operating temperature range:

-40° C to +110° C

Climatic test category:

250 VAC: 40/110/56/C

300 VAC: 40/110/56/B

in accordance with IEC

Insulation resistance at +20° C:

≥ 12 x 10³ MΩ

Measuring voltage: 100 V/1 min.

Dissipation factors:

tan δ ≤ 13 x 10⁻³ at 1 kHz and +20° C

Test specifications:

in accordance with IEC 60384-14

Approvals:

Country	Authority	Specification	Symbol		Approval-No.	
			250 VAC	300 VAC	250 VAC	300 VAC
Germany	VDE	IEC 60384-14			87455	40032534
USA/Canada	UL	UL 60384-14 CAN/CSA-E60384-14			E 100438	E 100438

Maximum pulse rise time 250 VAC:

Capacitance pF/μF	Pulse rise time V/μsec max. operation
1000 ... 4700	2500
6800 ... 0.022	1750

Maximum pulse rise time 300 VAC:

Capacitance pF/μF	Pulse rise time V/μsec max. operation
1000 ... 4700	2500
6800 ... 0.015	1850
0.022 ... 0.1	600

for pulses equal to a voltage amplitude with $\sqrt{2} \times 250 \text{ VAC} = 355 \text{ V}$
with $\sqrt{2} \times 300 \text{ VAC} = 425 \text{ V}$
according to IEC 60384-14

Test voltage: 2400 VDC, 2sec.

Reliability:

Operational life > 300 000 hours

Failure rate < 1 fit (0.5 x U_r and 40° C)

Mechanical Tests

Pull test on pins: 10 N in direction of pins according to IEC 60068-2-21

Vibration: 6 hours at 10...2000 Hz and 0.75 mm displacement amplitude or 10 g in accordance with IEC 60068-2-6

Low air density: 1kPa = 10 mbar in accordance with IEC 60068-2-13

Bump test: 4000 bumps at 390 m/sec² in accordance with IEC 60068-2-29

* If safety-approved EMI suppression capacitors are operated with a DC voltage being above the specified AC voltage rating the given approvals are no longer valid (IEC 60384-14).

Furthermore the permissible pulse rise time du/dt (F_{max.}) will be subject to a reduction according to

$$F_{\text{max.}} = F_r \times \sqrt{2} \times \text{UAC} / \text{UDC}$$

if the DC operating voltage UDC is higher than $\sqrt{2} \times \text{UAC}$

Packing

Available taped and reeled.

Detailed taping information and graphs at the end of the catalogue.

For further details and graphs please refer to Technical Information.

Continuation

General Data

Capacitance	250 VAC*					300 VAC*				
	W	H	L	PCM**	Part number	W	H	L	PCM**	Part number
1000 pF	4	8.5	13.5	10	MPY20W1100FA00_____	5	13	19	15	MPLY2W1100FC00_____
1500 „	4	8.5	13.5	10	MPY20W1150FA00_____	5	13	19	15	MPLY2W1150FC00_____
2200 „	4	8.5	13.5	10	MPY20W1220FA00_____	5	13	19	15	MPLY2W1220FC00_____
3300 „	4	8.5	13.5	10	MPY20W1330FA00_____	5	13	19	15	MPLY2W1330FC00_____
4700 „	5	10	13.5	10	MPY20W1470FB00_____	6	14	19	15	MPLY2W1470FD00_____
6800 „	5	13	19	15	MPY20W1680FC00_____	7	15	19	15	MPLY2W1680FE00_____
0.01 μF	5	13	19	15	MPY20W2100FC00_____	8	17	19	15	MPLY2W2100FF00_____
0.015 „	6	14	19	15	MPY20W2150FD00_____	10	18	19	15	MPLY2W2150FG00_____
0.022 „	7	15	19	15	MPY20W2220FE00_____	8	20	28	22.5	MPLY2W2220FH00_____
0.033 „						8	20	28	22.5	MPLY2W2330FH00_____
0.047 „						10	22	28	22.5	MPLY2W2470FI00_____
0.068 „						12	24	28	22.5	MPLY2W2680FJ00_____
0.1 μF						13	25	33	27.5	MPLY2W3100FK00_____

* f = 50/60 Hz

** PCM = Printed circuit module = pin spacing

Upon request with long pins 35-2 mm max.

Dims. in mm.

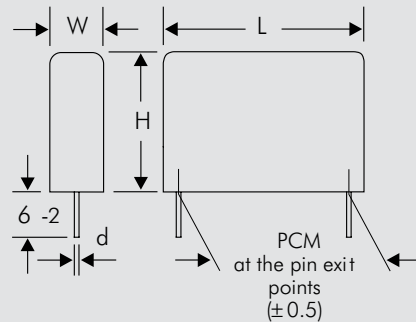

d = 0.6 ∅ if PCM 10
d = 0.8 ∅ if PCM ≥ 15

Part number completion:	
Tolerance:	20 % = M
Packing:	bulk = S
Pin length:	6-2 = SD
Taped version see page 145.	

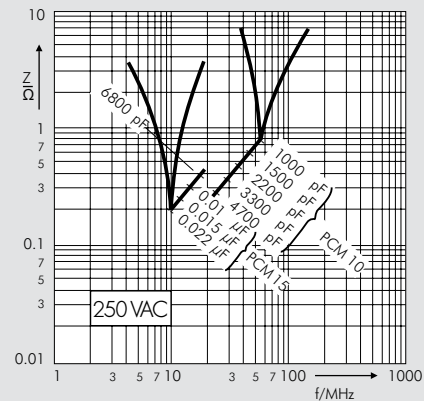

Impedance change with frequency (general guide)

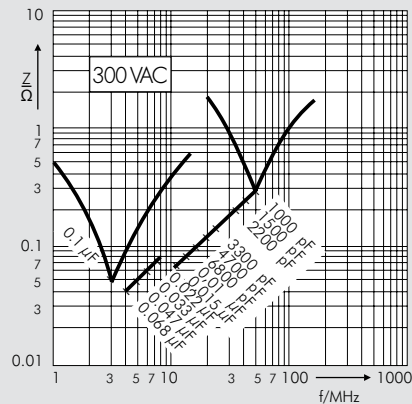

Impedance change with frequency (general guide)

Rights reserved to amend design data without prior notification.

WIMA Filter Capacitors



0.68 μF up to 75 μF and rated voltages of 250 VAC, 275 VAC, 305 VAC, 350 VAC and 440 VAC for an operational temperature range of -55°C to $+105^\circ\text{C}$. The 440 VAC range has an internal series connection and stands out for an increased corona discharge inception voltage.

Their metallized construction, i.e. a thin aluminium layer serving as electrode being vapour-deposited onto the insulating film, entails very good self-healing properties of WIMA filter capacitors in case of a dielectric breakdown. The short-circuit current causes the thin metal layer to vaporize around the discharge channel and thus forming an insulating "halo". The capacitor remains fully operative.

Further positive features are the dry construction and thus the waiver of additional impregnating agents, the very favourable capacitance/volume ratio and the long life time at high capacitance long-term stability even under demanding operating conditions.

WIMA capacitors are produced with the proven box technology using solvent-resistant, flame-retardant plastic cases according to UL 94 V-0. They are environmentally compatible with the RoHS 2011/65/EU regulations of the European Union.

WIMA MKP 4F

Due to their typical circuit position AC filter capacitors have to exhibit good high-frequency characteristics and at the same time high AC voltage capabilities. They in general fulfil two requirements:

- Low AC impedance to dissipate high-frequency interference signals
- Attenuation of transient voltage pulses caused e.g. by switching.

WIMA filter capacitors are designed on the basis of low-loss Polypropylene film and exhibit high AC current capability at high frequencies as well as low ESL and ESR values.

They are available with capacitances from



Metallized Polypropylen (PP) Filter Capacitors in PCM 27.5 mm to 52.5 mm. Capacitances from 0.68 μF to 75 μF . Rate Voltages from 230 VAC to 440 VAC.

Special Features

- High volume/capacitance ratio
- High peak current capabilities
- Self-healing
- Long lifetime
- According to RoHS 2011/65/EU

Typical Applications

- For high frequency applications e.g.
- AC filtering in UPS systems
 - Harmonic filter
 - Welding equipment
 - Renewable energy - grid interface

Construction

Dielectric:

Polypropylene (PP) film

Capacitor electrodes:

Vacuum-deposited

Internal construction:

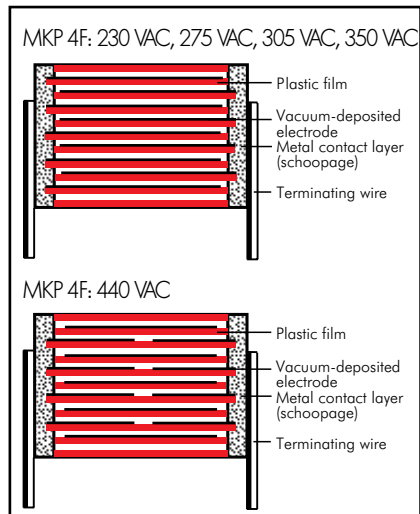

Encapsulation:

Solvent-resistant, flame-retardant plastic case with epoxy resin seal, UL 94 V-0

Terminations:

Tinned wire.

Marking:

Colour: Red. Marking: Black.
Epoxy resin seal: Red

Electrical Data

Capacitance range:

0.68 μF to 75 μF

Rated voltages: 230 VAC, 275 VAC, 305 VAC, 350 VAC, 440 VAC

Capacitance tolerances:

$\pm 20\%$, $\pm 10\%$, $\pm 5\%$

Operating temperature range:

-55°C to $+105^\circ\text{C}$

Climatic test category:

55/105/56 in accordance with IEC

Insulation resistance at $+20^\circ\text{C}$:

$\geq 30\,000$ sec ($\text{M}\Omega \times \mu\text{F}$)

Measuring voltage: 100 V/1 min.

Test voltage:

$1.5 U_{r,DC}$, 10sec.

Test specifications:

In accordance with IEC 61071 and 60068

Dissipation factors at $+20^\circ\text{C}$: $\tan \delta$

at f	PCM 27.5	PCM 37.5	PCM 52.5
1 kHz	$\leq 5 \times 10^{-4}$	$\leq 10 \times 10^{-4}$	$\leq 20 \times 10^{-4}$
10 kHz	$\leq 30 \times 10^{-4}$	$\leq 75 \times 10^{-4}$	$\leq 150 \times 10^{-4}$

Reference frequency 1 kHz in accordance with IEC 60384-1

Maximum pulse rise time:

PCM	max. pulse rise time V/ μsec at $T_A < 40^\circ\text{C}$				
	230 VAC	275 VAC	305 VAC	350 VAC	440 VAC
27.5	45	55	68	100	110
37.5	20	30	35	50	70
52.5	10	13	15	25	40

for pulses equal to the rated voltage ($U_{r,DC}$)

Mechanical Tests

Pull test on pins:

10 N in direction of pins according to IEC 60068-2-21

Vibration:

6 hours at 10...2000 Hz and 0.75 mm displacement amplitude or 10 g in accordance with IEC 60068-2-6

Low air density:

1kPa = 10 mbar in accordance with IEC 60068-2-13

Bump test:

4000 bumps at 390 m/sec^2 in accordance with IEC 60068-2-29

Voltage derating:

A voltage derating factor must be applied according to the graph:

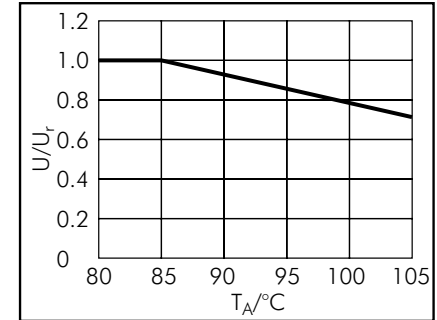

Reliability:

Operational life > 60000 hours at U_r
Failure rate < 10 fit ($0.5 \times U_r$ and 40°C)

Packing

Available taped and reeled up to and including case size 15 x 26 x 31.5 / PCM 27.5 mm.

Detailed taping information and graphs at the end of the catalogue.

For further details and graphs please refer to Technical Information.

Continuation

General Data

Capacitance	W	H	L	PCM**	Pin	230 VAC*/450 VDC		Part number
						I _s A	I _{rms} (10 kHz) at 85° C A	
1.0 μF	9	19	31.5	27.5	2	45	2.5	MKPF3Y41006A_____
1.5 "	11	21	31.5	27.5	2/4	70	3	MKPF3Y41506B_____
2.2 "	11	21	31.5	27.5	2/4	100	3.5	MKPF3Y42206B_____
3.3 "	13	24	31.5	27.5	2/4	150	5	MKPF3Y43306D_____
4.7 "	15	26	31.5	27.5	2/4	210	7.5	MKPF3Y44706F_____
6.8 "	17	29	31.5	27.5	2/4	300	8.5	MKPF3Y46806G_____
10 μF	20	39.5	31.5	27.5	2/4	450	11.5	MKPF3Y51006J_____
	19	32	41.5	37.5	2/4	200	8	MKPF3Y51007F_____
12 "	19	32	41.5	37.5	2/4	240	10	MKPF3Y51207F_____
15 "	20	39.5	41.5	37.5	2/4	300	12	MKPF3Y51507G_____
20 "	24	45.5	41.5	37.5	2/4	400	14	MKPF3Y52007H_____
22 "	24	45.5	41.5	37.5	2/4	440	15	MKPF3Y52207H_____
25 "	31	46	41.5	37.5	2/4	500	17	MKPF3Y52507I_____
30 "	31	46	41.5	37.5	2/4	600	19	MKPF3Y53007I_____
	25	45	57	52.5	2/4	300	15	MKPF3Y53009D_____
35 "	35	50	41.5	37.5	2/4	700	20.5	MKPF3Y53507J_____
	25	45	57	52.5	2/4	350	15	MKPF3Y53509D_____
40 "	30	45	57	52.5	2/4	400	17.5	MKPF3Y54009E_____
45 "	30	45	57	52.5	2/4	450	18.5	MKPF3Y54509E_____
50 "	35	50	57	52.5	4	500	21	MKPF3Y55009F_____
55 "	35	50	57	52.5	4	550	22	MKPF3Y55509F_____
60 "	45	55	57	52.5	4	600	23	MKPF3Y56009H_____
65 "	45	55	57	52.5	4	650	25.5	MKPF3Y56509H_____
70 "	45	55	57	52.5	4	700	26	MKPF3Y57009H_____
75 "	45	65	57	52.5	4	750	27	MKPF3Y57509J_____

* AC voltages: $f \leq 100$ Hz

** PCM = Printed circuit module = pin spacing

Dims. in mm.

Part number completion:	
Version code:	2-pin = 00 4-pin = D4
Tolerance:	20 % = M 10 % = K 5 % = J
Packing:	bulk = S
Pin length:	6-2 = SD
Taped version see page 145.	

2-pin version

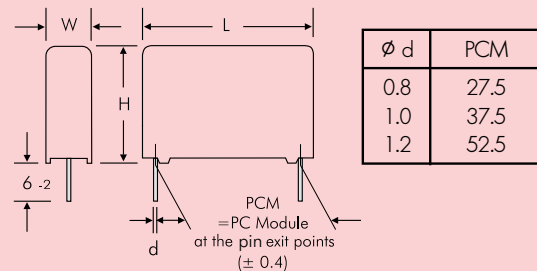

4-pin version

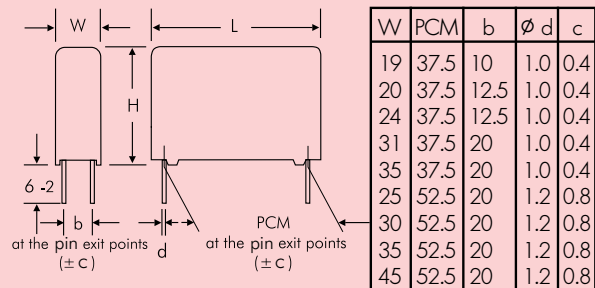

Rights reserved to amend design data without prior notification.

Continuation page 96

Continuation

General Data

Capacitance	W	H	L	PCM**	Pin	275 VAC*/600 VDC		Part number
						I _s A	I _{rms} (10 kHz) at 85° C A	
1.0 μF	9	19	31.5	27.5	2	55	2.5	MKPF1W41006A_____
1.5 "	11	21	31.5	27.5	2/4	80	3.5	MKPF1W41506B_____
2.2 "	13	24	31.5	27.5	2/4	120	5	MKPF1W42206D_____
3.3 "	15	26	31.5	27.5	2/4	180	5.5	MKPF1W43306F_____
4.7 "	17	34.5	31.5	27.5	2/4	260	8	MKPF1W44706I_____
6.8 "	20	39.5	31.5	27.5	2/4	370	10	MKPF1W46806J_____
10 μF	20	39.5	41.5	37.5	2/4	300	10	MKPF1W51007G_____
12 "	20	39.5	41.5	37.5	2/4	360	12	MKPF1W51207G_____
15 "	24	45.5	41.5	37.5	2/4	450	14	MKPF1W51507H_____
20 "	25	45	57	52.5	2/4	195	11	MKPF1W51509D_____
	31	46	41.5	37.5	2/4	600	16	MKPF1W52007I_____
22 "	25	45	57	52.5	2/4	260	12	MKPF1W52009D_____
	25	45	57	52.5	2/4	286	14	MKPF1W52209D_____
25 "	30	45	57	52.5	2/4	325	16	MKPF1W52509E_____
30 "	30	45	57	52.5	2/4	390	17	MKPF1W53009E_____
35 "	35	50	57	52.5	4	455	20	MKPF1W53509F_____
40 "	45	55	57	52.5	4	520	21	MKPF1W54009H_____
45 "	45	55	57	52.5	4	585	23	MKPF1W54509H_____
50 "	45	65	57	52.5	4	650	24	MKPF1W55009J_____

* AC voltages: $f \leq 100$ Hz

** PCM = Printed circuit module = pin spacing

Dims. in mm.

Part number completion:	
Version code:	2-pin = 00 4-pin = D4
Tolerance:	20 % = M 10 % = K 5 % = J
Packing:	bulk = S
Pin length:	6-2 = SD
Taped version see page 145.	

2-pin version

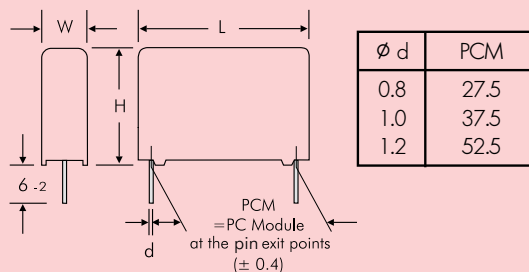

4-pin version

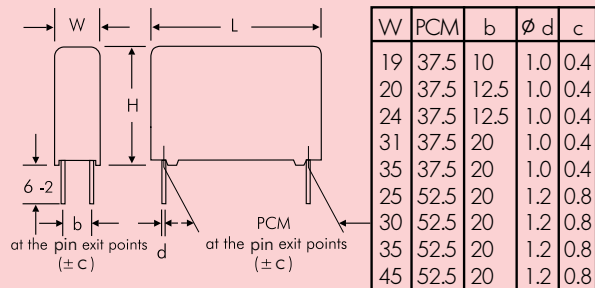

Rights reserved to amend design data without prior notification.

Continuation page 97

Continuation

General Data

Capacitance	W	H	L	PCM**	Pin	305 VAC*/630 VDC		Part number
						I_s A	I_{rms} (10 kHz) at 85° C A	
0.68 μ F	9	19	31.5	27.5	2	50	2	MKPF4W36806A_____
1.0 μ F	11	21	31.5	27.5	2/4	68	3	MKPF4W41006B_____
1.5 "	13	24	31.5	27.5	2/4	110	4	MKPF4W41506D_____
2.2 "	15	26	31.5	27.5	2/4	150	5	MKPF4W42206F_____
3.3 "	17	29	31.5	27.5	2/4	220	7	MKPF4W43306G_____
4.7 "	20	39.5	31.5	27.5	2/4	320	9	MKPF4W44706I_____
6.8 "	20	39.5	41.5	37.5	2/4	245	10	MKPF4W46807G_____
10 μ F	24	45.5	41.5	37.5	2/4	350	12	MKPF4W51007H_____
	25	45	57	52.5	2/4	150	10	MKPF4W51009D_____
12 "	24	45.5	41.5	37.5	2/4	420	13	MKPF4W51207H_____
15 "	31	46	41.5	37.5	2/4	525	15	MKPF4W51507I_____
	25	45	57	52.5	2/4	225	13	MKPF4W51509D_____
20 "	35	50	41.5	37.5	2/4	700	19	MKPF4W52007J_____
	30	45	57	52.5	2/4	300	14	MKPF4W52009E_____
22 "	35	50	57	52.5	4	330	16	MKPF4W52209F_____
25 "	35	50	57	52.5	4	375	17	MKPF4W52509F_____
30 "	45	55	57	52.5	4	450	21	MKPF4W53009H_____
35 "	45	65	57	52.5	4	525	22	MKPF4W53509J_____

* AC voltages: $f \leq 100$ Hz

** PCM = Printed circuit module = pin spacing

Dims. in mm.

Part number completion:	
Version code:	2-pin = 00 4-pin = D4
Tolerance:	20 % = M 10 % = K 5 % = J
Packing:	bulk = S
Pin length:	6-2 = SD
Taped version see page 145.	

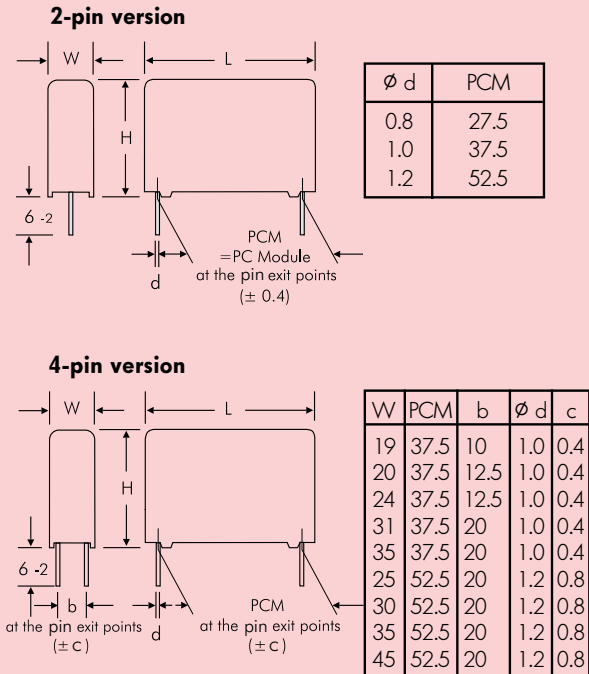

Rights reserved to amend design data without prior notification.

Continuation page 98

Continuation

General Data

Capacitance	W	H	L	PCM**	Pin	350 VAC*/700 VDC		Part number
						I _s A	I _{rms} (10 kHz) at 85° C A	
0.68 µF	9	19	31.5	27.5	2	70	1.5	MKPFBW36806A_____
1.0 µF	11	21	31.5	27.5	2/4	100	3	MKPFBW41006B_____
1.5 "	13	24	31.5	27.5	2/4	150	4	MKPFBW41506D_____
2.2 "	15	26	31.5	27.5	2/4	220	5	MKPFBW42206F_____
3.3 "	17	29	31.5	27.5	2/4	330	7	MKPFBW43306G_____
4.7 "	20	39.5	31.5	27.5	2/4	470	11	MKPFBW44706I_____
6.8 "	20	39.5	41.5	37.5	2/4	340	10	MKPFBW46807G_____
10 µF	24	45.5	41.5	37.5	2/4	500	13	MKPFBW51007H_____
	25	45	57	52.5	2/4	250	11	MKPFBW51009D_____
12 "	24	45.5	41.5	37.5	2/4	600	14	MKPFBW51207H_____
15 "	31	46	41.5	37.5	2/4	750	16	MKPFBW51507I_____
	25	45	57	52.5	2/4	375	13	MKPFBW51509D_____
20 "	35	50	41.5	37.5	2/4	1000	18	MKPFBW52007J_____
	30	45	57	52.5	2/4	500	16	MKPFBW52009E_____
22 "	35	50	57	52.5	4	550	18	MKPFBW52209F_____
25 "	35	50	57	52.5	4	625	19	MKPFBW52509F_____
30 "	45	55	57	52.5	4	750	22	MKPFBW53009H_____
35 "	45	65	57	52.5	4	870	25	MKPFBW53509J_____

Capacitance	W	H	L	PCM**	Pin	440 VAC*/1000 VDC		Part number
						I _s A	I _{rms} (10 kHz) at 85° C A	
0.68 "	13	24	31.5	27.5	2/4	74.8	3	MKPF4W36806D_____
1.0 µF	15	26	31.5	27.5	2/4	110	4	MKPF4W41006F_____
1.5 "	17	29	31.5	27.5	2/4	165	5	MKPF4W41506G_____
2.2 "	20	39.5	31.5	27.5	2/4	240	6	MKPF4W42206I_____
3.3 "	20	39.5	41.5	37.5	2/4	230	7.5	MKPF4W43307G_____
4.7 "	24	45.5	41.5	37.5	2/4	330	8.5	MKPF4W44707H_____
6.8 "	31	46	41.5	37.5	2/4	480	11.5	MKPF4W46807I_____
10 µF	35	50	57	52.5	4	400	16	MKPF4W51009F_____
12 "	35	50	57	52.5	4	480	17	MKPF4W51209F_____

* AC voltages: $f \leq 100$ Hz

** PCM = Printed circuit module = pin spacing

Dims. in mm.

Part number completion:	
Version code:	2-pin = 00 4-pin = D4
Tolerance:	20 % = M 10 % = K 5 % = J
Packing:	bulk = S
Pin length:	6-2 = SD
Taped version see page 145.	

Rights reserved to amend design data without prior notification.

Continuation page 99

Continuation

Impedance change with frequency
(general guide).

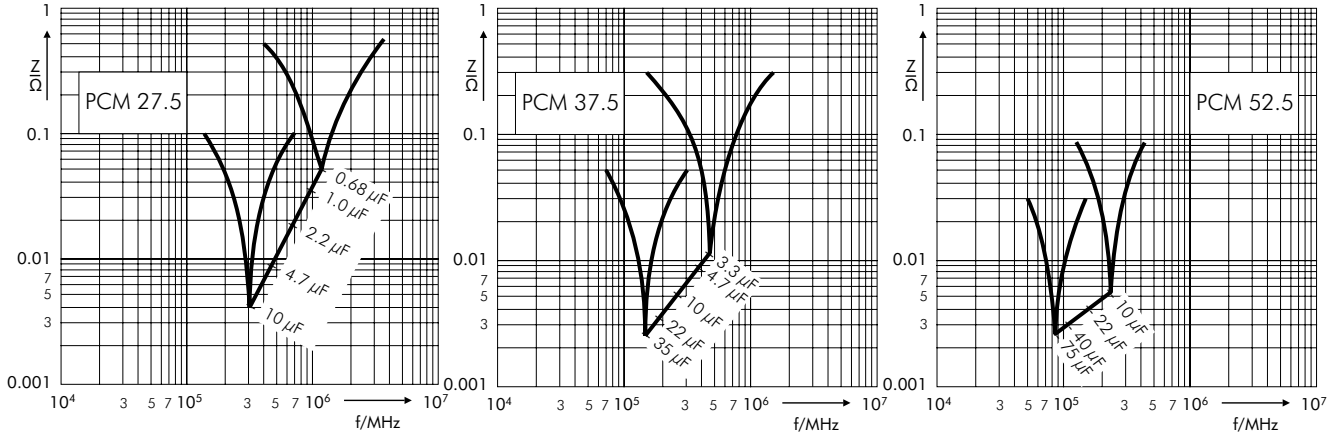

Permissible AC voltage in relation to frequency at 10° C internal temperature rise
(general guide).

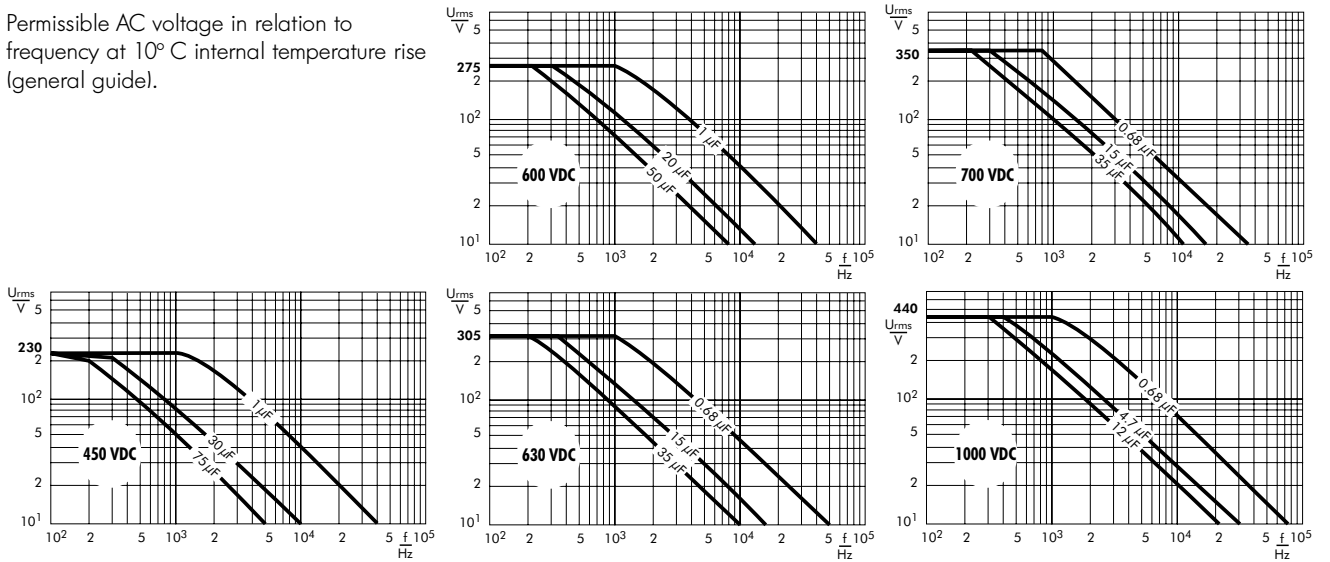

Permissible AC current in relation to frequency at 10° C internal temperature rise
(general guide).

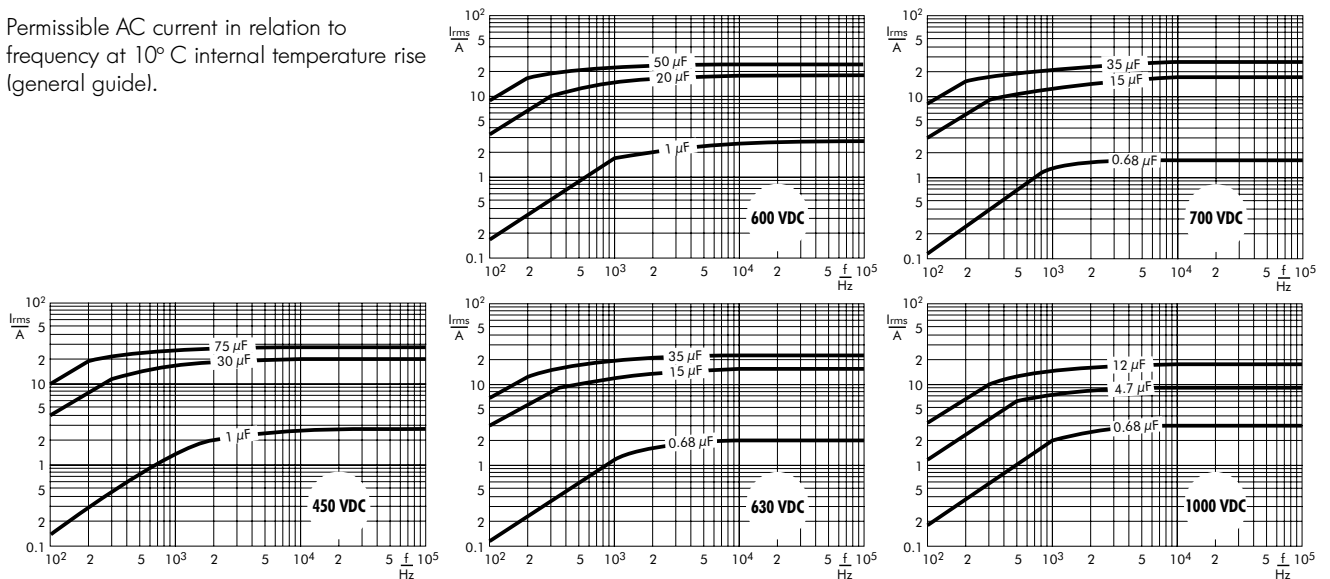

WIMA Snubber Capacitors with Plates or Lead Terminations for Best Contacts

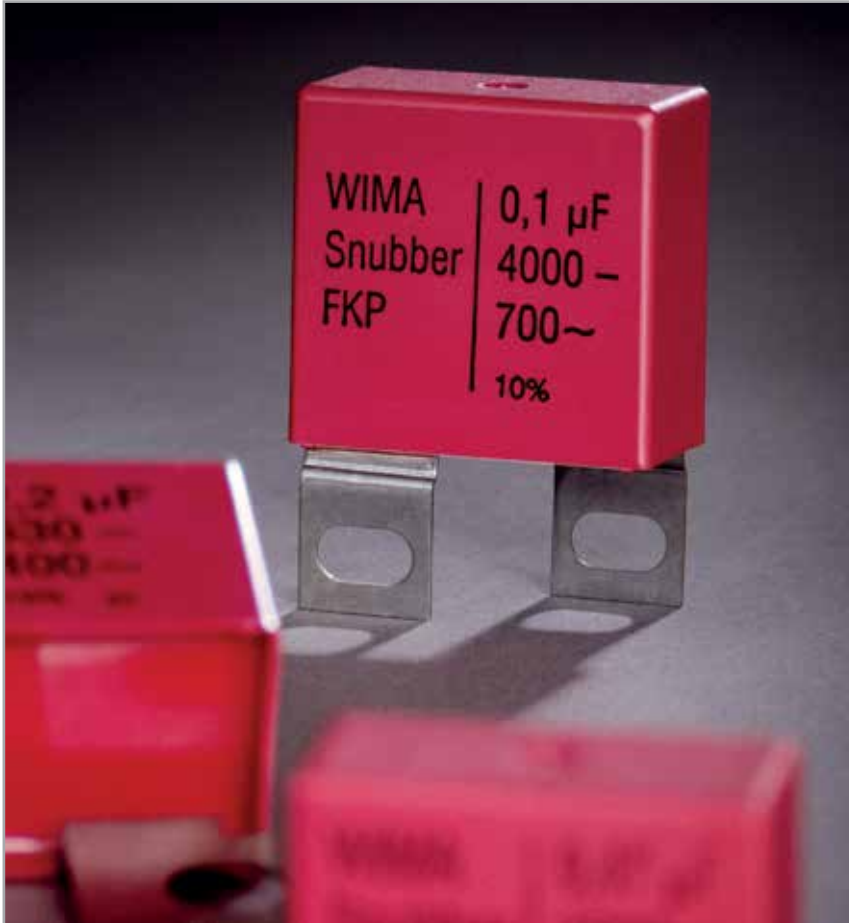

WIMA Snubber MKP

WIMA Snubber FKP

Development of the WIMA Snubber MKP and WIMA Snubber FKP capacitor series for high power conversion is based on decades of experience with Polypropylene film pulse capacitors.

WIMA Snubber capacitors are available both as double-sided metallized pulse version – WIMA Snubber MKP – and for extremely high pulse ratings in self-healing film/foil technology – WIMA Snubber FKP. Their electrical performance as well as the manifold number of available connecting options makes the WIMA Snubber technology unique:

- Plates soldered directly to the schoopage for safe contacts at high rms currents

- Low inductance construction achieved by end-surface contacts
- High pulse reliability due to double-sided metallization and/or film/foil construction
- High voltage/overvoltage strength by internal series connection with self-healing metallized floating electrode
- Available in various contact configurations
- Solvent-resistant, flame retardant plastic case in accordance with UL 94 V-0
- Production sites ISO 9001:2008 certified

WIMA Snubber capacitors are manufactured under conditions of large volume production, but are also available in small quantities as individually configurable high-rel. components.

WIMA Snubber capacitors are available with capacitances from 0.01 μF through 8.0 μF and with rated voltages from 630 VDC through 4000 VDC.

All components are environmentally compatible with the RoHS 2011/65/EU regulations of the European Union.



Snubber MKP Capacitors for Pulse Applications with Double-Sided Metallized Electrodes and Internal Series Connection. Capacitances from 0.047 μF to 8.0 μF . Rated Voltages from 700 VDC to 3000 VDC.

Special Features

- Pulse duty construction
- Self-healing
- Particularly reliable contact-configurations: 4-pin versions and screwable plate connections
- Internal series connection
- Very low dissipation factor
- Negative capacitance change versus temperature
- According to RoHS 2011/65/EU

Typical Applications

- For high pulse and high frequency applications requiring extremely reliable contacts e.g.
- IGBT-applications

Construction

Dielectric:

Polypropylene (PP) film

Capacitor electrodes:

Double-sided metallized plastic film

Internal construction:

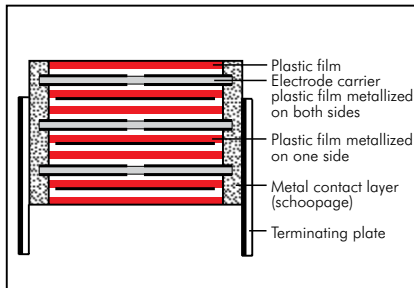

Encapsulation:

Solvent-resistant, flame-retardant plastic case with epoxy resin seal, UL 94 V-0

Terminations:

Tinned wire or plates.

Marking:

Colour: Red. Marking: Black.
Epoxy resin seal: Red

Electrical Data

Capacitance range: 0.047 μF to 8.0 μF

Rated voltages: 700 VDC, 850 VDC, 1000 VDC, 1250 VDC, 1700 VDC, 2000 VDC, 2500 VDC, 3000 VDC

Capacitance tolerances:

$\pm 20\%$, $\pm 10\%$, $\pm 5\%$ (other tolerances are available subject to special enquiry)

Operating temperature range:

-55°C to $+100^\circ\text{C}$

Insulation resistance at $+20^\circ\text{C}$:

$C \leq 0.33 \mu\text{F}$: $\geq 1 \times 10^5 \text{ M}\Omega$

(mean value: $5 \times 10^5 \text{ M}\Omega$)

$C > 0.33 \mu\text{F}$: $\geq 30\,000 \text{ sec (M}\Omega \times \mu\text{F)}$

(mean value: 100 000 sec)

Measuring voltage: 100 V/1 min.

Test voltage: 2 sec

L	$\leq 2000 \text{ VDC}$	2500 VDC	$\geq 3000 \text{ VDC}$
< 41.5	$1.6 U_r$	$1.4 U_r$	$1.2 U_r$
41.5	$1.4 U_r$	$1.4 U_r$	$1.2 U_r$
57	$1.2 U_r$	$1.2 U_r$	$1.2 U_r$

Dissipation factors at $+20^\circ\text{C}$: $\tan \delta$

at f	$C \leq 0.1 \mu\text{F}$	$0.1 \mu\text{F} < C \leq 1.0 \mu\text{F}$	$C > 1.0 \mu\text{F}$
1 kHz	$\leq 6 \times 10^{-4}$	$\leq 6 \times 10^{-4}$	$\leq 6 \times 10^{-4}$
10 kHz	$\leq 6 \times 10^{-4}$	$\leq 6 \times 10^{-4}$	-
100 kHz	$\leq 15 \times 10^{-4}$	-	-

Maximum pulse rise time:

Capacitance μF	max. pulse rise time V/ μsec at $T_A < 40^\circ\text{C}$								
	700 VDC	850 VDC	1000 VDC	1250 VDC	1700 VDC	2000 VDC	2500 VDC	3000 VDC	
0.047 ... 0.22	1150	1150	1800	1800	1800	1800	1800	1800	
0.33 ... 0.68	900	900	1150	1150	1150	1150	1150	1150	
1.0 ... 2.2	500	500	500	500	650	650	650	650	
2.5 ... 6.8	190	190	390	390	500	-	-	-	
7.0 ... 8.0	90	90	-	-	-	-	-	-	

for pulses equal to the rated voltage

Mounting Recommendation

Excessive mechanical strain, e.g. pressure or shock onto the capacitor body, is to be avoided during mounting and usage of the capacitors. When fixing the plates the screw torque is to be limited to max. 5 Nm.

For further details and graphs please refer to Technical Information.

Climatic test category:

55/100/56 in accordance with IEC

Voltage derating:

A voltage derating factor of 1.35 % per K must be applied from $+85^\circ\text{C}$ for DC voltages and from $+75^\circ\text{C}$ for AC voltages

Reliability:

Operational life $> 300\,000$ hours

Failure rate < 1 fit ($0.5 \times U_r$ and 40°C)

Specific dissipation:

Box size* WxHxL in mm	Specific dissipation in Watts per K above the ambient temperature
19x31x56	0.068
23x34x56	0.079
27x37.5x56	0.092
33x48x56	0.122
37x54x56	0.142

* other box sizes see page 11.

Packing

Packing units at the end of the catalogue.

Packing quantities may vary depending on the plate version.



Continuation

General Data

Capacitance	700 VDC/420 VAC*				850 VDC/450 VAC*				1000 VDC/600 VAC*			
	W	H	L	Part number	W	H	L	Part number	W	H	L	Part number
0.22 "									11	21	31.5	SNMPO132206B
									11	22	41.5	SNMPO132207B
0.33 "					15	26	31.5	SNMPM033306F	15	26	31.5	SNMPO133306F
					13	24	41.5	SNMPM033307C	13	24	41.5	SNMPO133307C
0.47 "	11	21	31.5	SNMPK034706B	17	29	31.5	SNMPM034706G	17	29	31.5	SNMPO134706G
	11	22	41.5	SNMPK034707B	15	26	41.5	SNMPM034707D	15	26	41.5	SNMPO134707D
0.68 "	15	26	31.5	SNMPK036806F	17	29	41.5	SNMPM036807E	17	29	41.5	SNMPO136807E
	13	24	41.5	SNMPK036807C								
1.0 µF	17	29	31.5	SNMPK041006G	19	32	41.5	SNMPM041007F	20	39.5	41.5	SNMPO141007G
	15	26	41.5	SNMPK041007D					23	34	56	SNMPO141008E
1.5 "	19	32	41.5	SNMPK041507F	20	39.5	41.5	SNMPM041507G	24	45.5	41.5	SNMPO141507H
					23	34	56	SNMPM041508E	23	34	56	SNMPO141508E
2.0 "	20	39.5	41.5	SNMPK042007G	24	45.5	41.5	SNMPM042007H	31	46	41.5	SNMPO142007I
					23	34	56	SNMPM042008E	27	37.5	56	SNMPO142008H
2.2 "	20	39.5	41.5	SNMPK042207G	24	45.5	41.5	SNMPM042207H	31	46	41.5	SNMPO142207I
					23	34	56	SNMPM042208E	27	37.5	56	SNMPO142208H
2.5 "	24	45.5	41.5	SNMPK042507H	31	46	41.5	SNMPM042507I	35	50	41.5	SNMPO142507J
					27	37.5	56	SNMPM042508H	33	48	56	SNMPO142508J
3.0 "	24	45.5	41.5	SNMPK043007H	31	46	41.5	SNMPM043007I	40	55	41.5	SNMPO143007K
					27	37.5	56	SNMPM043008H	33	48	56	SNMPO143008J
3.3 "	24	45.5	41.5	SNMPK043307H	35	50	41.5	SNMPM043307J	40	55	41.5	SNMPO143307K
					33	48	56	SNMPM043308J	33	48	56	SNMPO143308J
4.0 "	31	46	41.5	SNMPK044007I	35	50	41.5	SNMPM044007J	37	54	56	SNMPO144008L
					33	48	56	SNMPM044008J				
4.7 "	31	46	41.5	SNMPK044707I	33	48	56	SNMPM044708J	37	54	56	SNMPO144708L
5.0 "	31	46	41.5	SNMPK045007I	33	48	56	SNMPM045008J	37	54	56	SNMPO145008L
6.0 "	35	50	41.5	SNMPK046007J	37	54	56	SNMPM046008L	37	54	56	SNMPO146008L
	33	48	56	SNMPK046008J								
7.0 "	40	55	41.5	SNMPK047007K	37	54	56	SNMPM047008L				
	33	48	56	SNMPK047008J								
8.0 "	37	54	56	SNMPK048008L								

* AC voltages: $f \leq 1000 \text{ Hz}$; $1.4 \times U_{\text{rms}} + \text{UDC} \leq U_r$

 New range and values

Dims. in mm.

Ionisation inception level in isolated cases may be lower than admissible rated AC voltage.

Versions and dimensional drawings see page 108.

Part number completion:	
Version codes see page 110.	
Tolerance:	20 % = M
	10 % = K
	5 % = J
Packing:	bulk = S
Pin length:	6-2 = SD
	none = 00 (for plate versions)

Rights reserved to amend design data without prior notification.

Continuation page 103

Continuation

General Data

Capacitance	1250 VDC/600 VAC*				1700 VDC/650 VAC*				2000 VDC/700 VAC*			
	W	H	L	Part number	W	H	L	Part number	W	H	L	Part number
0.068 µF									11	21	31.5	SNMPTA026806B
									11	22	41.5	SNMPTA026807B
0.1 µF					11	21	31.5	SNMPTA31006B	13	24	31.5	SNMPTA031006D
					11	22	41.5	SNMPTA31007B	11	22	41.5	SNMPTA031007B
0.15 "					13	24	31.5	SNMPTA31506D	15	26	31.5	SNMPTA031506F
					11	22	41.5	SNMPTA31507B	13	24	41.5	SNMPTA031507C
0.22 "	11	21	31.5	SNMPTA032206B	15	26	31.5	SNMPTA32206F	15	26	41.5	SNMPTA032207D
	11	22	41.5	SNMPTA032207B	13	24	41.5	SNMPTA32207C				
0.33 "	15	26	31.5	SNMPTA033306F	17	34.5	31.5	SNMPTA33306I	19	32	41.5	SNMPTA033307F
	13	24	41.5	SNMPTA033307C	15	26	41.5	SNMPTA33307D				
0.47 "	17	29	31.5	SNMPTA034706G	19	32	41.5	SNMPTA34707F	20	39.5	41.5	SNMPTA034707G
	15	26	41.5	SNMPTA034707D					23	34	56	SNMPTA034708E
0.68 "	17	29	41.5	SNMPTA036807E	20	39.5	41.5	SNMPTA36807G	24	45.5	41.5	SNMPTA036807H
					23	34	56	SNMPTA36808E	27	37.5	56	SNMPTA036808H
1.0 µF	20	39.5	41.5	SNMPTA041007G	24	45.5	41.5	SNMPTA41007H	35	50	41.5	SNMPTA041007J
	23	34	56	SNMPTA041008E	27	37.5	56	SNMPTA41008H	33	48	56	SNMPTA041008J
1.5 "	24	45.5	41.5	SNMPTA041507H	31	46	41.5	SNMPTA41507I	40	55	41.5	SNMPTA041507K
	23	34	56	SNMPTA041508E	27	37.5	56	SNMPTA41508H	33	48	56	SNMPTA041508J
2.0 "	31	46	41.5	SNMPTA042007I	40	55	41.5	SNMPTA42007K	37	54	56	SNMPTA042008L
	27	37.5	56	SNMPTA042008H	33	48	56	SNMPTA42008J				
2.2 "	31	46	41.5	SNMPTA042207I	40	55	41.5	SNMPTA42207K	37	54	56	SNMPTA042208L
	27	37.5	56	SNMPTA042208H	33	48	56	SNMPTA42208J				
2.5 "	35	50	41.5	SNMPTA042507J	37	54	56	SNMPTA42508L				
	33	48	56	SNMPTA042508J								
3.0 "	40	55	41.5	SNMPTA043007K	37	54	56	SNMPTA43008L				
	33	48	56	SNMPTA043008J								
3.3 "	40	55	41.5	SNMPTA043307K								
	33	48	56	SNMPTA043308J								
4.0 "	37	54	56	SNMPTA044008L								
4.7 "	37	54	56	SNMPTA044708L								
5.0 "	37	54	56	SNMPTA045008L								
6.0 "	37	54	56	SNMPTA046008L								

* AC voltages: $f \leq 1000 \text{ Hz}$; $1.4 \times U_{\text{rms}} + \text{UDC} \leq U_r$

New range, box sizes and values

Dims. in mm.

Ionisation inception level in isolated cases may be lower than admissible rated AC voltage.

Versions and dimensional drawings see page 108.

Part number completion:	
Version codes	see page 110.
Tolerance:	20 % = M
	10 % = K
	5 % = J
Packing:	bulk = S
Pin length:	6-2 = SD
	none = 00 (for plate versions)

Rights reserved to amend design data without prior notification.

Continuation page 104

Continuation

General Data

Capacitance	2500 VDC/700 VAC*				3000 VDC/700 VAC*			
	W	H	L	Part number	W	H	L	Part number
0.047 μ F	11	21	31.5	SNMPV024706B	11	21	31.5	SNMPW024706B
	11	22	41.5	SNMPV024707B	11	22	41.5	SNMPW024707B
	13	24	31.5	SNMPV026806D	13	24	31.5	SNMPW026806D
	11	22	41.5	SNMPV026807B	11	22	41.5	SNMPW026807B
0.1 μ F	15	26	31.5	SNMPV031006F	15	26	31.5	SNMPW031006F
	13	24	41.5	SNMPV031007C	13	24	41.5	SNMPW031007C
0.15 "	15	26	41.5	SNMPV031507D	15	26	41.5	SNMPW031507D
0.22 "	19	32	41.5	SNMPV032207F	19	32	41.5	SNMPW032207F
0.33 "	24	45.5	41.5	SNMPV033307H	24	45.5	41.5	SNMPW033307H
0.47 "	31	46	41.5	SNMPV034707I	31	46	41.5	SNMPW034707I
	27	37.5	56	SNMPV034708H	27	37.5	56	SNMPW034708H
0.68 "	35	50	41.5	SNMPV036807J	35	50	41.5	SNMPW036807J
	33	48	56	SNMPV036808J	33	48	56	SNMPW036808J
1.0 μ F	40	55	41.5	SNMPV041007K	40	55	41.5	SNMPW041007K
	33	48	56	SNMPV041008J	33	48	56	SNMPW041008J
1.5 "	37	54	56	SNMPV041508L	37	54	56	SNMPW041508L

* AC voltages: $f \leq 1000$ Hz; $1.4 \times U_{rms} + U_{DC} \leq U_r$

 New range and values

Dims. in mm.

Ionisation inception level in isolated cases may be lower than admissible rated AC voltage.

Versions and dimensional drawings see page 108.

Part number completion:

Version codes see page 110.

Tolerance: 20 % = M

10 % = K

5 % = J

Packing: bulk = S

Pin length: 6-2 = SD

none = 00 (for plate versions)

Rights reserved to amend design data without prior notification.

Permissible AC voltage in relation to frequency at 10° C internal temperature rise (general guide).

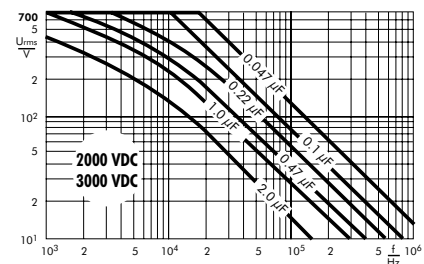
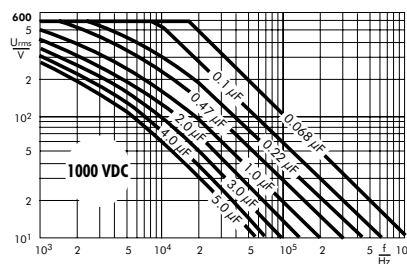
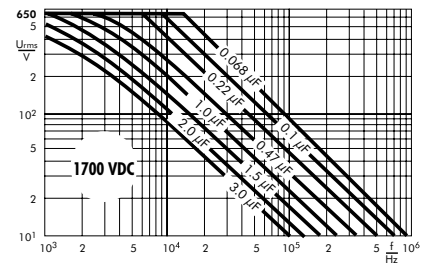
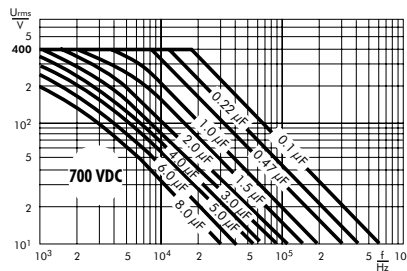

Snubber FKP Capacitors for High Pulse Applications with Metal Foil Electrodes and Metallized Internal Series Connection. Capacitances from 0.01 μF to 3.3 μF . Rated Voltages from 630 VDC to 4000 VDC.

Special Features

- High pulse duty
- Self-healing
- Particularly reliable contact-configurations: 4-pin versions and screwable plate connections
- Internal series connection
- Very low dissipation factor
- Negative capacitance change versus temperature
- According to RoHS 2011/65/EU

Typical Applications

For high pulse and high frequency applications requiring extremely reliable contacts e.g.

- IGBT-applications

Construction

Dielectric:

Polypropylene (PP) film

Capacitor electrodes:

Aluminium foil and single-sided metallized plastic film

Internal construction:

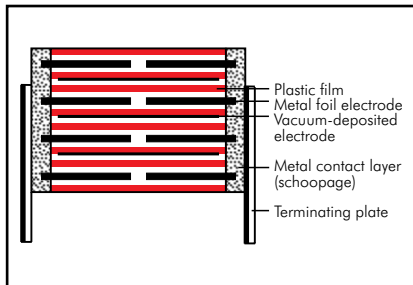

Encapsulation:

Solvent-resistant, flame-retardant plastic case with epoxy resin seal, UL 94 V-0

Terminations:

Tinned wire or plates.

Marking:

Colour: Red. Marking: Black.
Epoxy resin seal: Red

Electrical Data

Capacitance range: 0.01 μF to 3.3 μF
Rated voltages: 630 VDC, 1000 VDC, 1250 VDC, 1600 VDC, 2000 VDC, 3000 VDC, 4000 VDC

Capacitance tolerances:
 $\pm 20\%$, $\pm 10\%$, $\pm 5\%$ (other tolerances are available subject to special enquiry)

Operating temperature range:
 -55°C to $+100^\circ\text{C}$

Insulation resistance at $+20^\circ\text{C}$:

$C \leq 0.33 \mu\text{F}$: $\geq 1 \times 10^5 \text{ M}\Omega$

(mean value: $5 \times 10^5 \text{ M}\Omega$)

$C > 0.33 \mu\text{F}$: $\geq 30\,000 \text{ sec (M}\Omega \times \mu\text{F)}$

(mean value: 100 000 sec)

Measuring voltage: 100 V/1 min.

Test voltage: 2 sec

L	$\leq 2000 \text{ VDC}$	$\geq 3000 \text{ VDC}$
< 41.5	$1.6 U_r$	$1.2 U_r$
41.5	$1.4 U_r$	$1.2 U_r$
56	$1.2 U_r$	$1.2 U_r$

Climatic test category:

55/100/56 in accordance with IEC

Voltage derating:

A voltage derating factor of 1.35 % per K must be applied from $+85^\circ\text{C}$ for DC voltages and from $+75^\circ\text{C}$ for AC voltages

Reliability:

Operational life > 300 000 hours

Failure rate < 1 fit ($10.5 \times U_r$ and 40°C)

Specific dissipation:

Box size* WxHxL in mm	Specific dissipation in Watts per K above the ambient temperature
19x31x56	0.068
23x34x56	0.079
27x37.5x56	0.092
33x48x56	0.122
37x54x56	0.142

* other box sizes see page 11.

Dissipation factors

 at $+20^\circ\text{C}$: $\tan \delta$

at f	$C \leq 0.1 \mu\text{F}$	$0.1 \mu\text{F} < C \leq 1.0 \mu\text{F}$	$C > 1.0 \mu\text{F}$
1 kHz	$\leq 6 \times 10^{-4}$	$\leq 6 \times 10^{-4}$	$\leq 6 \times 10^{-4}$
10 kHz	$\leq 6 \times 10^{-4}$	$\leq 6 \times 10^{-4}$	-
100 kHz	$\leq 15 \times 10^{-4}$	-	-

Maximum pulse rise time:

Capacitance μF	max. pulse rise time V/ μsec at $T_A < 40^\circ\text{C}$						
	630 VDC	1000 VDC	1250 VDC	1600 VDC	2000 VDC	3000 VDC	4000 VDC
0.01 ... 0.022	-	11000	11000	11000	11000	11000	11000
0.033 ... 0.068	9000	9000	9000	9000	9000	9000	9000
0.1 ... 0.22	9000	9000	9000	9000	9000	9000	9000
0.33 ... 0.68	5000	5000	5000	5000	5000	5000	5000
1.0 ... 3.3	1600	2000	2000	2000	-	-	-

for pulses equal to the rated voltage

Mounting Recommendation

Excessive mechanical strain, e.g. pressure or shock onto the capacitor body, is to be avoided during mounting and usage of the capacitors. When fixing the plates the screw torque is to be limited to max. 5 Nm.

For further details and graphs please refer to Technical Information.

Packing

Packing units at the end of the catalogue.

Packing quantities may vary depending on the plate version.

Continuation

General Data

Capacitance	630 VDC/400 VAC*				1000 VDC/600 VAC*			
	W	H	L	Part number	W	H	L	Part number
0.022 μ F					11	22	41.5	SNFPO122207B_____
0.033 "					11	22	41.5	SNFPO123307B_____
0.047 "	11	22	41.5	SNFPJ024707B_____	11	22	41.5	SNFPO124707B_____
0.068 "	11	22	41.5	SNFPJ026807B_____	11	22	41.5	SNFPO126807B_____
0.1 μ F	11	22	41.5	SNFPJ031007B_____	11	22	41.5	SNFPO131007B_____
0.15 "	11	22	41.5	SNFPJ031507B_____	15	26	41.5	SNFPO131507D_____
0.22 "	13	24	41.5	SNFPJ032207C_____	17	29	41.5	SNFPO132207E_____
0.33 "	15	26	41.5	SNFPJ033307D_____	19	32	41.5	SNFPO133307F_____
0.47 "	17	29	41.5	SNFPJ034707E_____	20	39.5	41.5	SNFPO134707G_____
0.68 "	19	32	41.5	SNFPJ036807F_____	24	45.5	41.5	SNFPO136807H_____
					23	34	56	SNFPO136808E_____
1.0 μ F	20	39.5	41.5	SNFPJ041007G_____	31	46	41.5	SNFPO141007L_____
					27	37.5	56	SNFPO141008H_____
1.5 "	24	45.5	41.5	SNFPJ041507H_____	35	50	41.5	SNFPO141507J_____
					33	48	56	SNFPO141508J_____
2.2 "	31	46	41.5	SNFPJ042207I_____	37	54	56	SNFPO142208L_____
	27	37.5	56	SNFPJ042208H_____				
2.5 "	35	50	41.5	SNFPJ042507J_____				
	33	48	56	SNFPJ042508J_____				
3.0 "	37	54	56	SNFPJ043008L_____				
3.3 "	37	54	56	SNFPJ043308L_____				

Capacitance	1250 VDC/600 VAC*				1600 VDC/650 VAC*			
	W	H	L	Part number	W	H	L	Part number
0.01 μ F					11	22	41.5	SNFPT021007B_____
0.015 "					11	22	41.5	SNFPT021507B_____
0.022 "	11	22	41.5	SNFPR022207B_____	11	22	41.5	SNFPT022207B_____
0.033 "	11	22	41.5	SNFPR023307B_____	11	22	41.5	SNFPT023307B_____
0.047 "	11	22	41.5	SNFPR024707B_____	11	22	41.5	SNFPT024707B_____
0.068 "	11	22	41.5	SNFPR026807B_____	15	26	41.5	SNFPT026807D_____
0.1 μ F	11	22	41.5	SNFPR031007B_____	17	29	41.5	SNFPT031007E_____
0.15 "	15	26	41.5	SNFPR031507D_____	19	32	41.5	SNFPT031507F_____
0.22 "	17	29	41.5	SNFPR032207E_____	20	39.5	41.5	SNFPT032207G_____
0.33 "	19	32	41.5	SNFPR033307F_____	24	45.5	41.5	SNFPT033307H_____
0.47 "	20	39.5	41.5	SNFPR034707G_____	31	46	41.5	SNFPT034707I_____
					27	37.5	56	SNFPT034708H_____
0.68 "	24	45.5	41.5	SNFPR036807H_____	35	50	41.5	SNFPT036807J_____
	23	34	56	SNFPR036808E_____	27	37.5	56	SNFPT036808H_____
1.0 μ F	31	46	41.5	SNFPR041007I_____	33	48	56	SNFPT041008J_____
	27	37.5	56	SNFPR041008H_____				
1.5 "	33	48	56	SNFPR041508J_____				

* AC voltages: $f \leq 1000 \text{ Hz}$; $1.4 \times U_{rms} + U_{DC} \leq U_r$

■ New range, values and box sizes

Dims. in mm.

Ionisation inception level in isolated cases may be lower than admissible rated AC voltage.

Versions and dimensional drawings see page 108.

Rights reserved to amend design data without prior notification.

Part number completion:

Version codes see page 110.

Tolerance: 20 % = M

10 % = K

5 % = J

Packing: bulk = S

Pin length: 6-2 = SD

none = 00 (for plate versions)

Continuation page 107

Continuation

General Data

Capacitance	2000 VDC/700 VAC*				3000 VDC/700 VAC*				4000 VDC/700 VAC*			
	W	H	L	Part number	W	H	L	Part number	W	H	L	Part number
0.01 μF	11	22	41.5	SNFPU021007B	11	22	41.5	SNFPW021007B	11	22	41.5	SNFPX021007B
0.015 "	11	22	41.5	SNFPU021507B	11	22	41.5	SNFPW021507B	11	22	41.5	SNFPX021507B
0.022 "	11	22	41.5	SNFPU022207B	11	22	41.5	SNFPW022207B	13	24	41.5	SNFPX022207C
0.033 "	13	24	41.5	SNFPU023307C	13	24	41.5	SNFPW023307C	15	26	41.5	SNFPX023307D
0.047 "	15	26	41.5	SNFPU024707D	15	26	41.5	SNFPW024707D	17	29	41.5	SNFPX024707E
0.068 "	17	29	41.5	SNFPU026807E	17	29	41.5	SNFPW026807E	19	32	41.5	SNFPX026807F
0.1 μF	17	29	41.5	SNFPU031007E	19	32	41.5	SNFPW031007F	20	39.5	41.5	SNFPX031007G
0.15 "	20	39.5	41.5	SNFPU031507G	20	39.5	41.5	SNFPW031507G	24	45.5	41.5	SNFPX031507H
0.22 "	24	45.5	41.5	SNFPU032207H	24	45.5	41.5	SNFPW032207H	31	46	41.5	SNFPX032207I
0.33 "	31	46	41.5	SNFPU033307I	31	46	41.5	SNFPW033307I	27	37.5	56	SNFPX032208H
0.47 "	27	37.5	56	SNFPU033308H	27	37.5	56	SNFPW033308H	33	48	56	SNFPX033308J
0.68 "	33	48	56	SNFPU036808J	33	48	56	SNFPW036808J				

* AC voltages: $f \leq 1000 \text{ Hz}$; $1.4 \times U_{\text{rms}} + \text{UDC} \leq U_r$

New values and box sizes

Dims. in mm.

Ionisation inception level in isolated cases may be lower than admissible rated AC voltage.

Versions and dimensional drawings see page 108.

Part number completion:

Version codes see page 110.

Tolerance: 20 % = M

10 % = K

5 % = J

Packing: bulk = S

Pin length: 6-2 = SD

none = 00 (for plate versions)

Rights reserved to amend design data without prior notification.

Permissible AC voltage in relation to frequency at 10° C internal temperature rise (general guide).

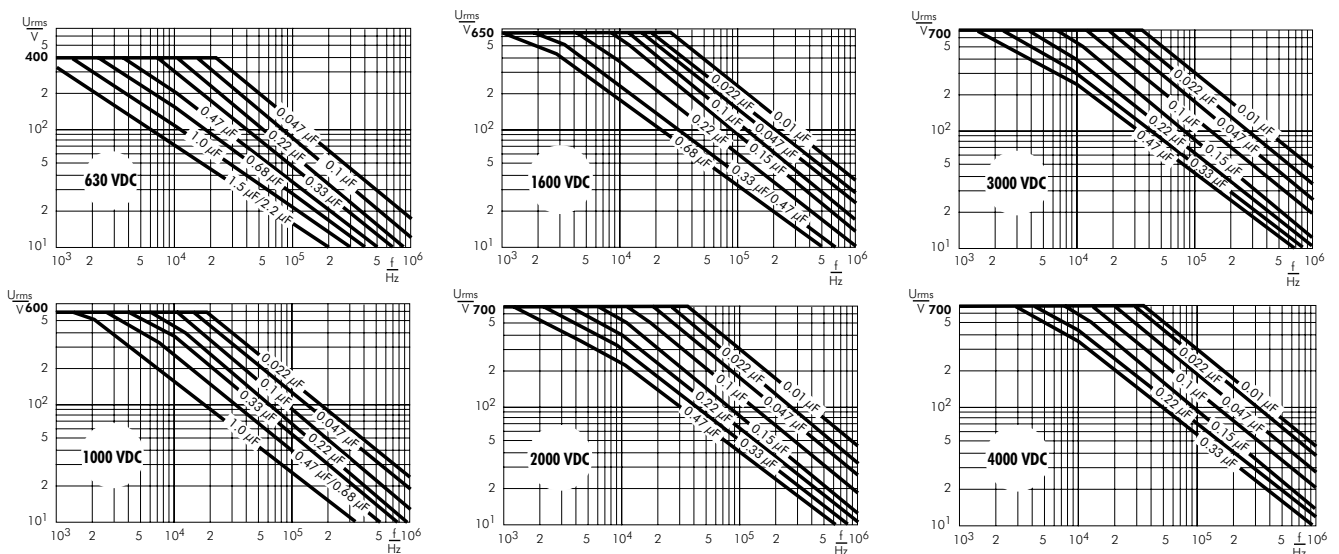

Versions of WIMA Snubber- and DC-LINK MKP 4- Capacitors

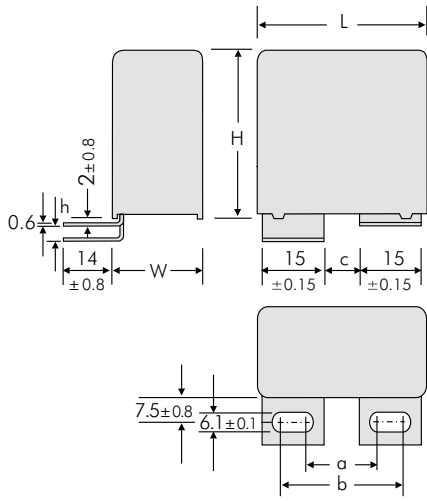

Version	L	a ±0.5	b ±0.5	c ±0.5	h ±0.8
A1	41.5	17.5	28	7.5	0
A1.5	41.5	17.5	28	7.5	3.5
A1	56	20	30	10	0
A1.1.1	56	28	38	18	0
A1.4.1	56	28	38	18	3.5

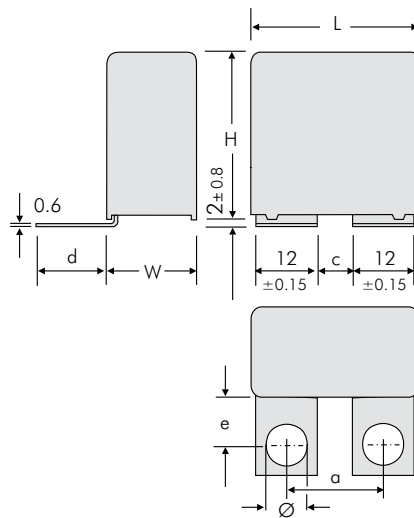

Version	L	a ±0.5	c ±0.5	d ±0.8	e ±0.8	Ø ±0.1
A1.6	41.5	18	6	21.5	16	7
A1.6.1	41.5	22	10	18.5	13	7
A1.6.2	41.5	23	10	18.5	13	8
A1.6	56	29	17	21.5	16	7

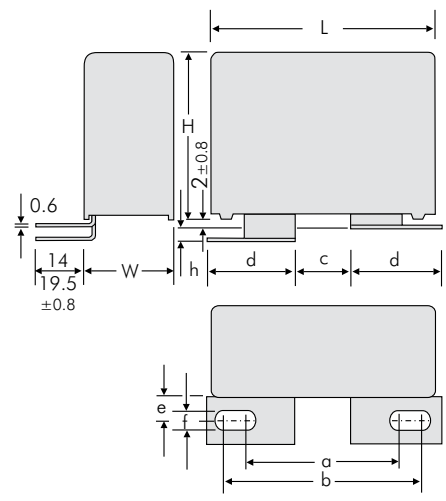

Version	L	a ±0.5	b ±0.5	c ±0.5	d ±0.15	e ±0.8	f ±0.1	h ±0.8
A2	41.5	36	46.5	14.5	22	7.5	8.4	0
A2.4.1	41.5	33.5	39.5	7.5	22	13	8.4	0
A2.6.1	41.5	31.5	41.5	14	22	13	6.1	3.5
A2.6.2	41.5	31.5	41.5	14	22	13	6.1	0
A2.8	41.5	36	46.5	14.5	22	7.5	8.4	3.5
A2.1	56	39.5	45.5	13.5	22	7.5	8.4	0
A2.1.2	56	36	45.5	14.5	21.5	7.5	8.4	0

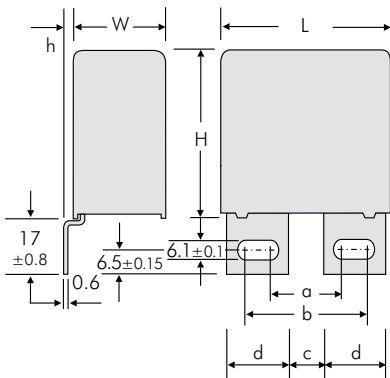

Version	L	a ±0.5	b ±0.5	c ±0.5	d ±0.15	h ±0.8
A3	41.5	17.5	27.5	7.5	15	0
A3.5	41.5	17.5	27.5	7.5	15	3
A3.12	41.5	17.5	30	7.5	16.5	0
A3	56	20	30	10	15	0
A3.1	56	28	38	18	15	0
A3.5	56	20	30	10	15	3
A3.10	56	28	38	18	15	3

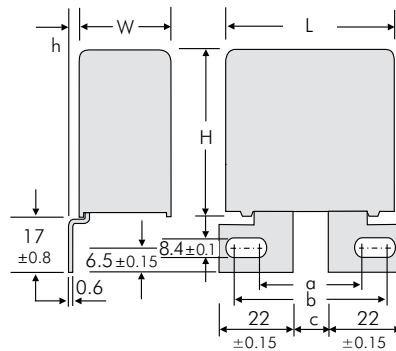

Version	L	a ±0.5	b ±0.5	c ±0.5	h ±0.8
A3.9	41.5	36	46.5	14.5	0
A3.11	41.5	36	46.5	14.5	3
A3.2	56	36	46.5	14.5	0
A3.3	56	36	46.5	14.5	3

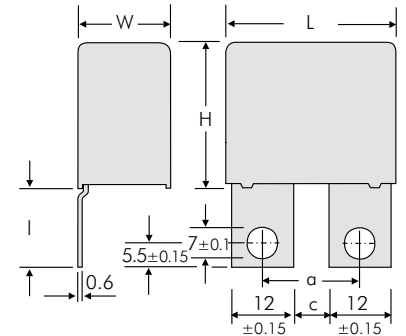

Version	L	a ±0.5	c ±0.5	l ±0.8
A3.8	41.5W ≥ 17	18	6	23
A3.8.1	41.5W ≥ 17	22	10	17.5
A3.8.2	41.5W ≥ 17	22	10	23

Versions of WIMA Snubber- and DC-LINK MKP 4- Capacitors

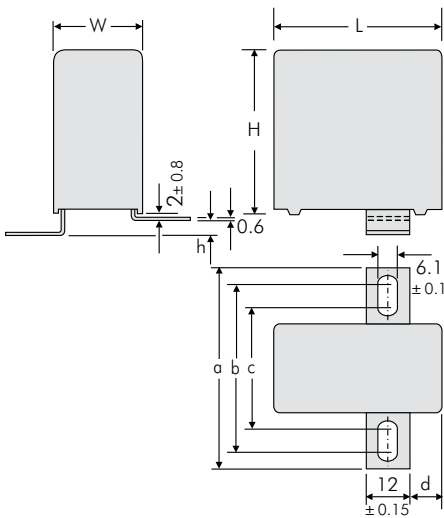

Version	L	a ±0.8	b ±0.8	c ±0.8	d ±1.0	h ±0.8	W
A4.1	41.5	57	47	31	6	3.5	19
A4.5	41.5	57	47	31	6	0	19

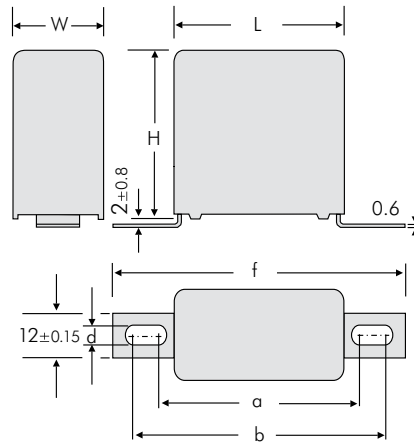

Version	L	a ±0.8	b ±0.8	f ±0.8	d ±0.1
A4.9	31.5 W ≥ 15	44	47	57	4.5
A4.10	31.5 W ≥ 15	43	59	69	6.1
A4.2	41.5 W ≥ 15	54	57	67	4.5
A4	41.5 W ≥ 15	53	69	79	6.1
A4.7	56	65	68	78	4.5
A4	56	64	80	90	6.1

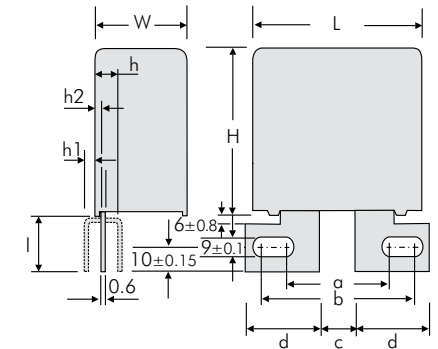

Version	W	a ±0.5	b ±0.5	c ±0.5	d ±0.15	h ±0.8	h1 ±0.8	h2 ±0.8	l ±0.8
A6	≥23	41.5	45.5	15.5	24.15	7	-	-	26
A6.3	≥19	35	39	18	19	-	5	3	25
A6.4	≥23	42.8	44.8	21	21.5	-	-	6.4	26

2-pin version

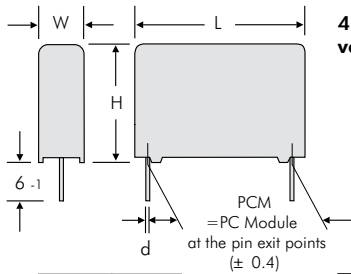

PCM	d
22.5	0.8
27.5	0.8
38.5	1.2
49.5	1.2

4-pin version

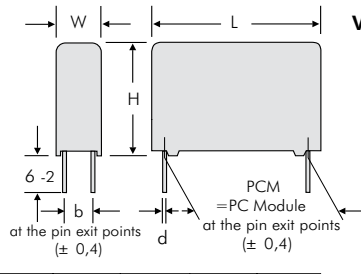

W	H	L	PCM	b	d
11	21	31.5	27.5	5	0.8
13	24	31.5	27.5	7.5	0.8
15	26	31.5	27.5	7.5	0.8
17	29	31.5	27.5	10	0.8
19	30	31.5	27.5	10	0.8
17	34.5	31.5	27.5	10	0.8
20	39.5	31.5	27.5	12.5	0.8
22	43.5	31.5	27.5	12.5	0.8
11	22	41.5	37.5	5	1
13	24	41.5	37.5	7.5	1
15	26	41.5	37.5	7.5	1
17	29	41.5	37.5	10	1
19	32	41.5	37.5	10	1
20	39.5	41.5	37.5	12.5	1
24	45.5	41.5	37.5	12.5	1
31	46	41.5	37.5	20	1
35	50	41.5	37.5	20	1
40	55	41.5	37.5	20	1
19	31	56	48.5	12.5	1
23	34	56	48.5	15	1
27	37.5	56	48.5	15	1
33	48	56	48.5	20	1
37	54	56	48.5	20	1

Version B*

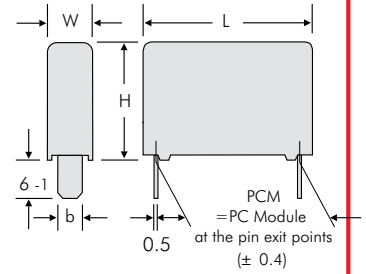

L	PCM	b ±0.15
31.5	28.5	8
41.5	38.5	8
56	49.5	8

Dims. in mm

Additional special versions can be realized. Please contact us with your specific needs.

* Processing notification:
Processing should be done within 3 month after manufacturing.



Versions of WIMA Snubber- and DC-LINK MKP 4- Capacitors

Version code		D2	D4	B8*	A1	1A	1B	1G	1H	1I	1J	1S	2A	2B	2Q	2F	2J	2K	2M	3A	3C	3D	3E	3G	3K	3L	3M	3N	3O	3P	3Q	4A	4B	4C	4F	4J	4L	4M	6A	6B	6C							
W x H x L	Size code	2-pin	4-pin	B8																																												
		11 x 21 x 31.5	6B																																													
13 x 24 x 31.5	6D																																															
15 x 26 x 31.5	6F																																															
17 x 29 x 31.5	6G																																															
17 x 34.5 x 31.5	6I																																															
11 x 22 x 41.5	7B																																															
13 x 24 x 41.5	7C																																															
15 x 26 x 41.5	7D																																															
17 x 29 x 41.5	7E																																															
19 x 32 x 41.5	7F																																															
20 x 39.5 x 41.5	7G																																															
24 x 45.5 x 41.5	7H																																															
31 x 46 x 41.5	7I																																															
35 x 50 x 41.5	7J																																															
40 x 55 x 41.5	7K																																															
19 x 31 x 56	8D																																															
23 x 34 x 56	8E																																															
27 x 37.5 x 56	8H																																															
33 x 48 x 56	8J																																															
37 x 54 x 56	8L																																															

Possible connecting respective plate versions - depending on box size.

■ 4-pin versions on request.

* Processing notification:
Processing should be done within
3 month after manufacturing.

WIMA GTO Capacitors with Screw Connection for High Current Carrying Capability



- High rms current carrying capability
- Very low dissipation factor
- Negative capacitance change versus temperature
- Excellent self-healing properties
- Outstanding mechanical stability
- High shock and vibration resistance
- Solvent-resistant, flame-retardant plastic case in accordance with UL 94 V-0
- Almost unlimited life expectancy

Fields of applications are designs where high current and voltage carrying capabilities are required, e.g. converter equipment in power generation or in traction technology for train drives, hoists, crane drives etc.

WIMA GTO MKP capacitors are available with capacitances from 1.0 μF through 100 μF and with nominal voltages from 400 VDC through 2000 VDC. For mounting purposes M6 and M8 threaded terminations are possible. Customer-specific requirements can be realized on demand.

WIMA GTO MKP

WIMA GTO MKP capacitors are especially designed to attenuate voltage spikes on GTO (Gate-Turn-Off) Thyristors and IGBT (Insulated Gate Bipolar Transistor). They are manufactured in dry-type technology with double-sided metallized electrodes and encapsulated in a cylindrical plastic case sealed with self-extinguishing polyurethane resin.

Their construction principle combined with the Polypropylene dielectric used creates outstanding features, e.g.:

- Very low self-inductance
- High pulse reliability

All components are environmentally compatible with the RoHS 2011/65/EU regulations of the European Union.



GTO MKP Capacitors for Pulse Applications with Internal Series Connection. Capacitances from 1.0 μF to 100 μF . Rated Voltages from 400 VDC to 2000 VDC.

Special Features

- Pulse duty construction
- Self-healing
- Cylindrical capacitor body with axial screw and thread connections size M6 or M8
- Internal series connection from 400 VAC
- Very low dissipation factor
- Negative capacitance change versus temperature
- According to RoHS 2011/65/EU

Typical Applications

For high pulse and high frequency applications requiring extremely reliable contacts e.g.

- Damping of voltage spikes on GTO-Thyristors

Construction

Dielectric:

Polypropylene (PP) film

Capacitor electrodes:

Double-sided metallized plastic film

Internal construction:

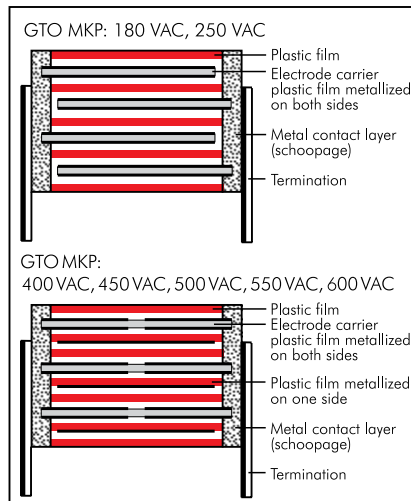

Encapsulation:

Solvent-resistant, flame-retardant plastic case with PU seal, UL 94 V-0

Terminations:

Axial screw connection M6 or M8.

Marking:

Colour: Red. Marking: Black on Silver.

Electrical Data

Capacitance range:

1.0 μF to 100 μF

Rated voltages:

400 VDC, 600 VDC, 850 VDC, 1000 VDC, 1200 VDC, 1500 VDC, 2000 VDC

Capacitance tolerances:

$\pm 20\%$, $\pm 10\%$, $\pm 5\%$

Operating temperature range:

-55°C to $+85^\circ\text{C}$

Climatic test category:

55/085/56 in accordance with IEC

Insulation resistance at $+20^\circ\text{C}$:

$\geq 10\,000$ sec ($\text{M}\Omega \times \mu\text{F}$)

(mean value: 50 000 sec)

Measuring voltage: 100 V/1 min.

Test voltage: $1.2 U_r$, 2 sec.

Dielectric absorption:

0.05%

Dissipation factors at $+20^\circ\text{C}$: $\tan \delta$

at f	$C \leq 20 \mu\text{F}$	$20 \mu\text{F} < C \leq 50 \mu\text{F}$	$C > 50 \mu\text{F}$
1 kHz	$\leq 3 \times 10^{-4}$	$\leq 5 \times 10^{-4}$	$\leq 8 \times 10^{-4}$

Voltage derating:

A voltage derating factor of 1.35 % per K must be applied from $+65^\circ\text{C}$ for DC voltages and from $+60^\circ\text{C}$ for AC voltages.

Reliability:

Operational life $> 300\,000$ hours

Failure rate < 1 fit ($0.5 \times U_r$ and 40°C)

Specific dissipation:

Box size D x L in mm	Specific dissipation in Watts per K above the ambient temperature
60 x 49	0.186
70 x 49	0.231
80 x 49	0.280
90 x 49	0.333
90 x 58	0.364
90 x 97	0.501

Mounting Recommendation

Excessive mechanical strain, e.g. pressure or shock onto the capacitor body, is to be avoided during mounting and usage of the capacitors. When fixing the capacitor the screw torque is to be limited to max. 5 Nm.

For further details and graphs please refer to Technical Information.

Packing

Transportation-safe packing in cardboard boxes.

Packing units

D	pcs. per packing unit
60	12
70	8
80	6
90	6

Continuation

General Data

Capacitance	400 VDC/180 VAC*				600 VDC/250 VAC*			
	D x L mm	du/dt V/μsec	I _{max.} A	Part number	D x L mm	du/dt V/μsec	I _{max.} A	Part number
3.5 μF					60 x 49	200	770	GTOMI04350GA00_
4 "					60 x 49	200	890	GTOMI04400GA00_
4.5 "					60 x 49	200	990	GTOMI04450GA00_
5 "					60 x 49	180	1090	GTOMI04500GA00_
6 "					60 x 49	180	1310	GTOMI04600GA00_
8 "					60 x 49	80	610	GTOMI04800GA00_
10 μF					60 x 49	80	780	GTOMI05100GA00_
15 "	60 x 49	50	790	GTOMG05150GA00_	60 x 49	80	1150	GTOMI05150GA00_
20 "	60 x 49	50	1050	GTOMG05200GA00_	70 x 49	80	1540	GTOMI05200GB00_
25 "	60 x 49	50	1330	GTOMG05250GA00_	70 x 49	80	1940	GTOMI05250GB00_
30 "	60 x 49	50	1610	GTOMG05300GA00_	80 x 49	80	2340	GTOMI05300GC00_
40 "	70 x 49	50	2090	GTOMG05400GB00_	90 x 49	80	3080	GTOMI05400GD00_
50 "	80 x 49	50	2680	GTOMG05500GC00_	90 x 58	60	3050	GTOMI05500GE00_
60 "	80 x 49	50	3240	GTOMG05600GC00_	90 x 97	35	2140	GTOMI05600GF00_
70 "	90 x 49	50	3630	GTOMG05700GD00_	90 x 97	35	2520	GTOMI05700GF00_
80 "	90 x 49	50	4100	GTOMG05800GD00_	90 x 97	35	2810	GTOMI05800GF00_
90 "	90 x 58	40	3800	GTOMG05900GE00_	90 x 97	35	3200	GTOMI05900GF00_
100 μF	90 x 58	40	4300	GTOMG06100GE00_	90 x 97	35	3550	GTOMI06100GF00_

Capacitance	850 VDC/400 VAC*				1000 VDC/450 VAC*			
	D x L mm	du/dt V/μsec	I _{max.} A	Part number	D x L mm	du/dt V/μsec	I _{max.} A	Part number
3 μF	60 x 49	200	770	GTOMM04300GA00_	60 x 49	260	790	GTOMO14300GA00_
3.5 "	60 x 49	200	770	GTOMM04350GA00_	60 x 49	260	910	GTOMO14350GA00_
4 "	60 x 49	200	890	GTOMM04400GA00_	60 x 49	260	1050	GTOMO14400GA00_
4.5 "	60 x 49	200	990	GTOMM04450GA00_	60 x 49	260	1170	GTOMO14450GA00_
5 "	60 x 49	200	1090	GTOMM04500GA00_	60 x 49	260	1310	GTOMO14500GA00_
6 "	60 x 49	200	1310	GTOMM04600GA00_	60 x 49	260	1550	GTOMO14600GA00_
8 "	60 x 49	200	1740	GTOMM04800GA00_	70 x 49	260	2080	GTOMO14800GB00_
10 μF	70 x 49	200	2190	GTOMM05100GB00_	70 x 49	260	2600	GTOMO15100GB00_
15 "	70 x 49	200	3230	GTOMM05150GB00_	90 x 49	260	3920	GTOMO15150GD00_
20 "	80 x 49	200	4310	GTOMM05200GC00_	90 x 58	200	4300	GTOMO15200GE00_
25 "	90 x 49	200	5390	GTOMM05250GD00_	90 x 97	120	3050	GTOMO15250GF00_
30 "	90 x 58	160	4800	GTOMM05300GE00_	90 x 97	120	3580	GTOMO15300GF00_
40 "	90 x 97	100	3780	GTOMM05400GF00_	90 x 97	120	4770	GTOMO15400GF00_
50 "	90 x 97	100	4790	GTOMM05500GF00_				
60 "	90 x 97	100	5800	GTOMM05600GF00_				

* AC voltage: $f \leq 1000 \text{ Hz}$; $1.4 \times U_{\text{rms}} + \text{UDC} \leq U_r$

Ionisation inception level in isolated cases may be lower than admissible rated AC voltage.

Part number completion:

Tolerance: 20 % = M
 10 % = K
 5 % = J
 Packing: bulk = S
 Pin length: none = 00

Rights reserved to amend design data without prior notification.

Continuation page 114

Continuation

General Data

Capacitance	1200 VDC/500 VAC*				1500 VDC/550 VAC*			
	D x L mm	du/dt V/μsec	I _{max.} A	Part number	D x L mm	du/dt V/μsec	I _{max.} A	Part number
1 μF					60 x 49	400	420	GTOMS04100GA00
1.5 "					60 x 49	400	590	GTOMS04150GA00
2 "					60 x 49	400	820	GTOMS04200GA00
2.5 "	60 x 49	300	770	GTOMQ04250GA00	60 x 49	400	1010	GTOMS04250GA00
3 "	60 x 49	300	950	GTOMQ04300GA00	60 x 49	400	1220	GTOMS04300GA00
3.5 "	60 x 49	300	1070	GTOMQ04350GA00	60 x 49	400	1400	GTOMS04350GA00
4 "	60 x 49	300	1230	GTOMQ04400GA00	70 x 49	400	1630	GTOMS04400GB00
4.5 "	60 x 49	300	1380	GTOMQ04450GA00	70 x 49	400	1800	GTOMS04450GB00
5 "	60 x 49	300	1570	GTOMQ04500GA00	70 x 49	400	2010	GTOMS04500GB00
6 "	70 x 49	300	1840	GTOMQ04600GB00	80 x 49	400	2390	GTOMS04600GC00
8 "	70 x 49	300	2470	GTOMQ04800GB00	90 x 49	400	3210	GTOMS04800GD00
10 μF	80 x 49	300	3080	GTOMQ05100GC00	90 x 58	320	3210	GTOMS05100GE00
15 "	90 x 58	230	3550	GTOMQ05150GE00	90 x 97	180	2690	GTOMS05150GF00
20 "	90 x 97	130	2690	GTOMQ05200GF00	90 x 97	180	3600	GTOMS05200GF00
25 "	90 x 97	130	3370	GTOMQ05250GF00				
30 "	90 x 97	130	4110	GTOMQ05300GF00				

Capacitance	2000 VDC/600 VAC*			
	D x L mm	du/dt V/μsec	I _{max.} A	Part number
1 μF	60 x 49	500	500	GTOMU04100GA00
1.5 "	60 x 49	500	750	GTOMU04150GA00
2 "	70 x 49	500	1000	GTOMU04200GB00
2.5 "	70 x 49	500	1250	GTOMU04250GB00
3 "	80 x 49	500	1500	GTOMU04300GC00
3.5 "	80 x 49	500	1750	GTOMU04350GC00
4 "	90 x 49	500	2000	GTOMU04400GD00
4.5 "	90 x 49	500	2250	GTOMU04450GD00
5 "	90 x 58	500	2500	GTOMU04500GE00
6 "	90 x 58	450	2700	GTOMU04600GE00
8 "	90 x 97	400	3200	GTOMU04800GF00
10 μF	90 x 97	300	3000	GTOMU05100GF00

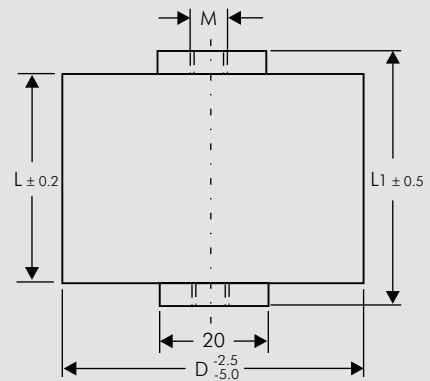

D	L	L1	M
60	49	55	M6
70	49	55	M6
80	49	55	M8
90	49	55	M8
90	58	64	M8
90	97	103	M8

* AC voltage: $f \leq 1000 \text{ Hz}$; $1.4 \times U_{\text{rms}} + \text{UDC} \leq U_r$

Ionisation inception level in isolated cases may be lower than admissible rated AC voltage.

Part number completion:	
Tolerance:	20 % = M 10 % = K 5 % = J
Packing:	bulk = S
Pin length:	none = 00

Rights reserved to amend design data without prior notification.

Continuation page 115

Continuation

Permissible AC voltage in relation to frequency at 20° C internal temperature rise (general guide).

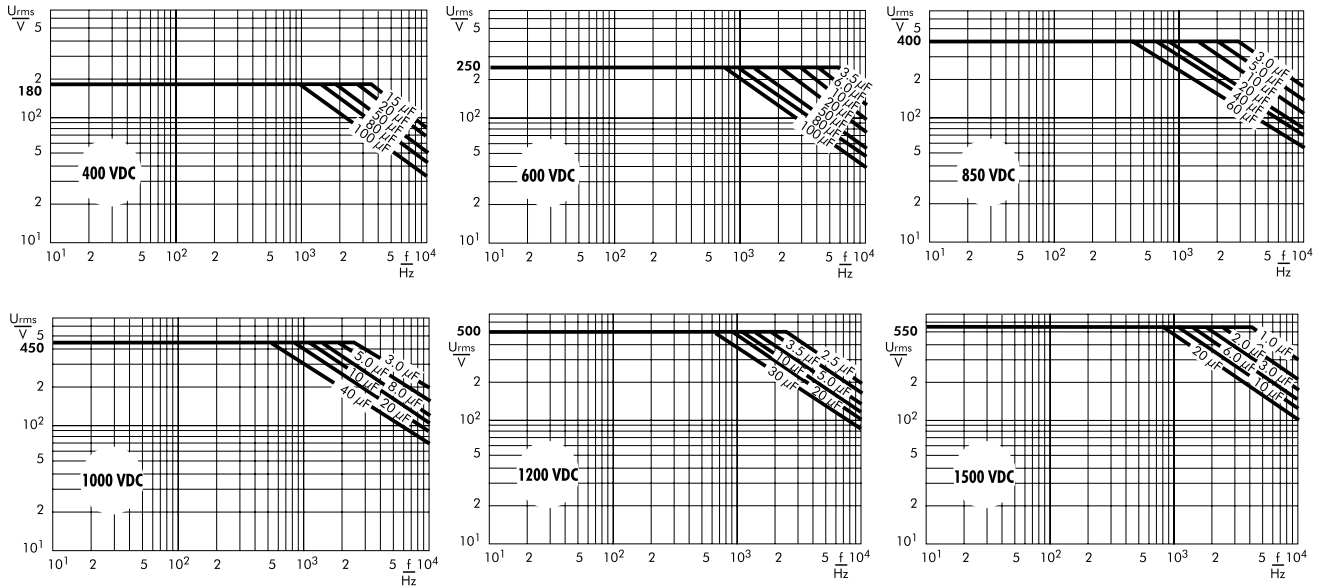

Permissible AC current in relation to frequency at 20° C internal temperature rise (general guide).

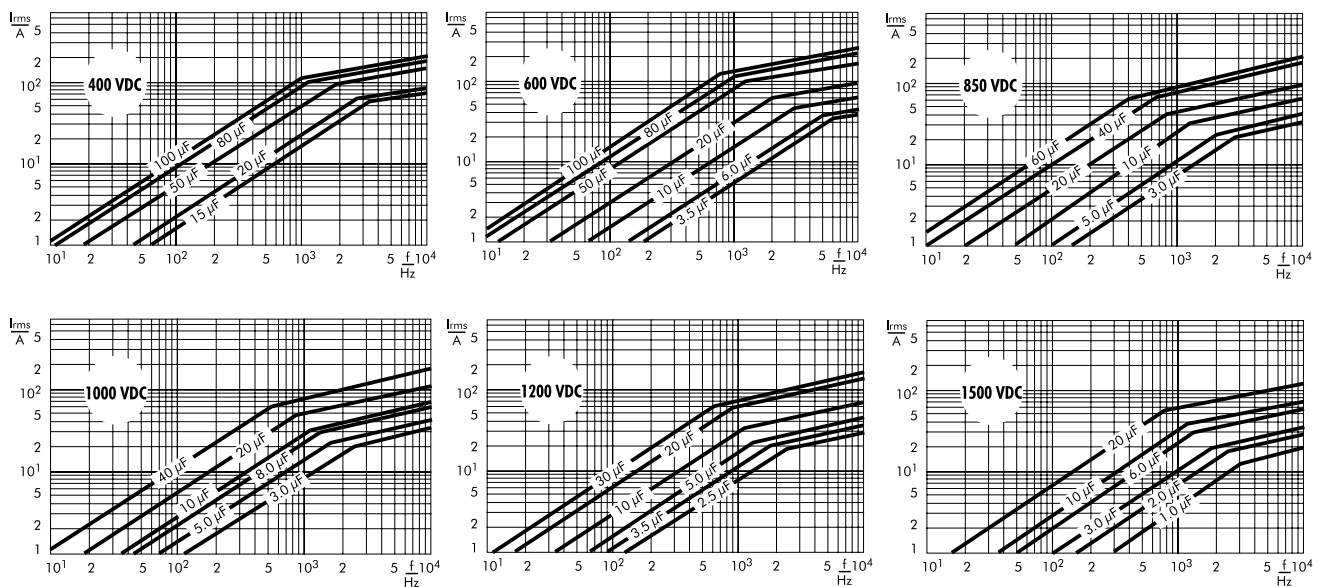

WIMA Intermediate Circuit Capacitors for Applications in High Power Converter Technology



- Particularly reliable contact configuration
- High shock and vibration resistance
- Outstanding mechanical stability

WIMA DC-LINK MKP 3 capacitors in cylindrical case with screw fixing are available with capacitances from 35 μF through 200 μF and with voltage ranges from 700 VDC through 1500 VDC. They can be provided with male or female terminations.

WIMA DC-LINK MKP 4 capacitors with rectangular case are available with capacitance values from 1 μF through 400 μF and with rated voltages from 400 VDC through 1300 VDC. For mounting purposes 2-pin and 4-pin versions are possible. The WIMA DC-LINK MKP 4S series has been designed for stringent requirements.

WIMA DC-LINK MKP 5 capacitors in cylindrical plastic case are available with capacitances from 16 μF through 260 μF and with rated voltages from 500 VDC through 1300 VDC. They are provided with tinned wire terminations for PCB mounting.

WIMA DC-LINK MKP 6 capacitors have a cylindrical aluminium case. They are available with capacitances from 75 μF through 4920 μF and with rated voltages from 600 VDC through 1500 VDC. For bus bar mounting they are designed with male or female terminations and screw bolt.

- WIMA DC-LINK MKP 3**
- WIMA DC-LINK MKP 4**
- WIMA DC-LINK MKP 4S**
- WIMA DC-LINK MKP 5**
- WIMA DC-LINK MKP 6**
- WIMA DC-LINK HC**
- WIMA DC-LINK HY**

WIMA DC-LINK capacitors are especially designed for applications in high power converter technology where they are more and more substituting electrolytic capacitors due to increasing electrical requirements. Manufactured with a low loss Polypropylene dielectric they show a higher current carrying capability as well as lower dissipation/self-heating at high frequencies compared to electrolytic capacitors. Further outstanding features are, e.g.:

- Very high capacitance/volume ratio
- High voltage rating per component
- Very low dissipation factor (ESR)
- Very high insulation resistance
- Excellent self-healing properties
- Long life expectancy
- Non-polar construction

Customized solutions e.g. can be realized with WIMA DC-LINK HC and WIMA DC-LINK HY with variable connecting configurations.

All components are environmentally compatible with the RoHS 2011/65/EU regulations of the European Union.



Metallized Polypropylene (PP) - Capacitors for DC-Link Applications. Capacitances from 35 μF to 200 μF . Rated Voltages from 700 VDC to 1500 VDC.

Special Features

- Very high volume/capacitance ratio
- Self-healing properties
- With cylindrical plastic case and screw fixing
- Dry construction without electrolyte or oil
- No internal fuse required
- Negative capacitance change versus temperature
- Very low dielectric absorption
- According to RoHS 2011/65/EU
- Customer-specific capacitances or voltages on request

Typical Applications

- DC capacitors with high capacitances for applications in power electronics also at non-sinusoidal voltages and currents e.g. in
- Wind power systems
 - Inverters

Construction

Dielectric:

Polypropylene (PP) film

Capacitor electrodes:

Vacuum-deposited

Internal construction:

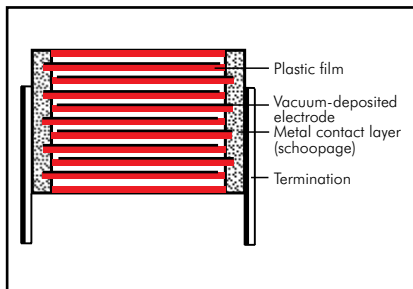

Encapsulation:

Solvent-resistant, flame-retardant plastic case with PU-sealing and screw fixing, UL 94 V-0

Terminations:

Screw connection (male or female).

Marking:

Colour: Black. Marking: Gold.

Electrical Data

Capacitance range: 35 μF to 200 μF
Rated voltages: 700 VDC, 900 VDC, 1100 VDC, 1300 VDC, 1500 VDC
Capacitance tolerances: $\pm 20\%$, $\pm 10\%$, ($\pm 5\%$ available subject to special enquiry)
Operating temperature range: -40°C to $+85^\circ\text{C}$
Insulation resistance at $+20^\circ\text{C}$:
 $\geq 5000 \text{ sec (M}\Omega \times \mu\text{F)}$
 (mean value: 20 000 sec)
 Measuring voltage: 100 V/1 min.

Dielectric loss factor $\tan \delta_0$: 2×10^{-4}

Test voltage: $1.5 U_n$, 2sec

Dielectric absorption: 0.05 %

Reliability:

Operational life > 100 000 hours
 Failure rate < 50 fit (hot spot $\leq 70^\circ\text{C}$)

Mounting Recommendation

Excessive mechanical strain, e.g. pressure or shock onto the capacitor body, is to be avoided during mounting and usage of the capacitors.

Packing

Transport-safe packing in cardboard boxes.

For further details and graphs please refer to Technical Information.

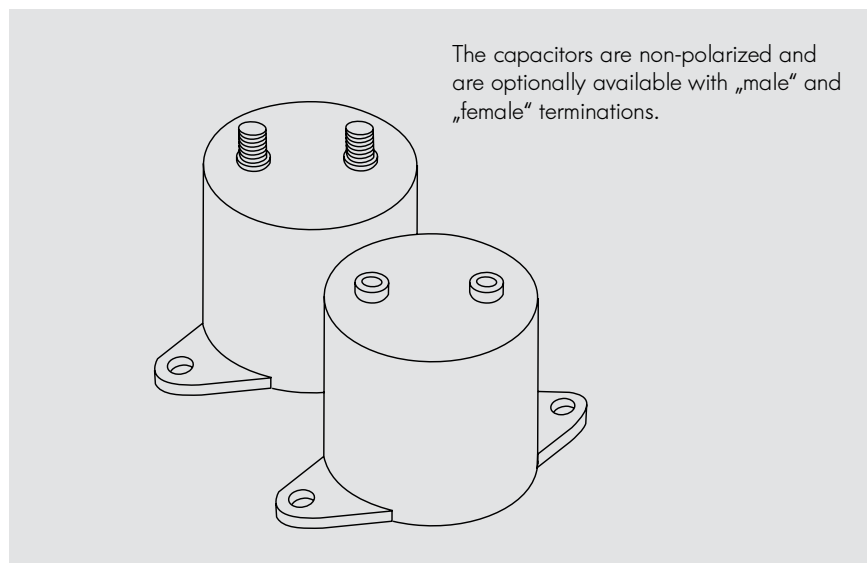

Continuation

General Data

U_R	C_N	D x L mm	I_{rms} (1 kHz)* A	ESR (1 kHz)* m Ω	R_{th} K/W	L_e nH	Approx. weight g	Part number
700 VDC	150 μ F	84.5 x 51	100	0.9	7.0	< 32	430	DCP3K06150G100_-----
	200 "	84.5 x 64	100	1.0	8.5	< 40	510	DCP3K06200G200_-----
900 VDC	100 μ F	84.5 x 51	90	1.0	7.2	< 30	430	DCP3N06100G100_-----
	140 "	84.5 x 64	100	1.3	8.5	< 40	510	DCP3N06140G200_-----
1100 VDC	70 μ F	84.5 x 51	100	1.1	7.0	< 32	430	DCP3P05700G100_-----
	90 "	84.5 x 64	100	1.2	8.5	< 40	510	DCP3P05900G200_-----
1300 VDC	50 μ F	84.5 x 51	60	1.7	7.0	< 35	430	DCP3R25500G100_-----
	70 "	84.5 x 64	50	2.1	8.5	< 40	510	DCP3R25700G200_-----
1500 VDC	35 μ F	84.5 x 51	60	1.7	7.0	< 35	430	DCP3S05350G100_-----
	50 "	84.5 x 64	70	1.9	8.5	< 40	510	DCP3S05500G200_-----

Contacts can handle: peak currents \hat{I} up to 5 kA
surge currents I_S up to 20 kA

Customer-specific capacitances or voltages on request

* General guide

Dims. in mm.

female

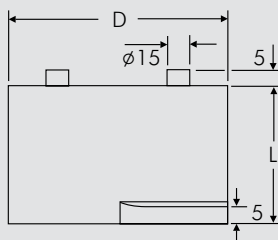

male

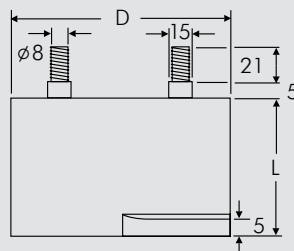

Part number completion:

Tolerance: 20 % = M
10 % = K
5 % = J
Packing: bulk = S
Connection: male = 0M
female = 0F

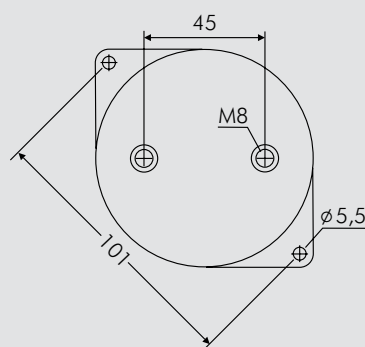
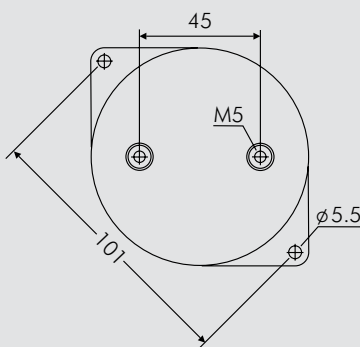

D	L
84.5	51
84.5	64

Rights reserved to amend design data without prior notification.

Metallized Polypropylene (PP) - Capacitors for DC-Link Applications.

Capacitances from 1.0 μF to 400 μF .
Rated Voltages from 400 VDC to 1300 VDC.

Special Features

- Capacitances up to 400 μF
- High volume/capacitance ratio
- Excellent self-healing properties
- Very low dissipation factor
- High reliability
- 2-pin and 4-pin contact configuration (plate versions on request)
- AEC-Q200 qualified
- According to RoHS 2011/65/EU

Typical Applications

As intermediate circuit capacitor e.g. in high power converter technology, power supplies, solar inverters etc.

Construction

Dielectric:

Polypropylene (PP) film

Capacitor electrodes:

Vacuum-deposited

Internal construction:

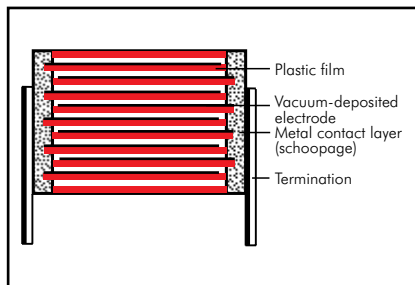

Encapsulation:

Solvent-resistant, flame-retardant plastic case with epoxy resin seal, UL 94 V-0

Terminations:

Tinned wire (plate versions on request).

Marking:

Colour: Red. Marking: Black.

Epoxy resin seal: Red

Electrical Data

Capacitance range: 1 μF to 400 μF
(intermediate values on request)

Rated voltages: 400VDC, 500VDC, 600VDC, 800VDC, 900VDC, 1100VDC, 1300VDC

Capacitance tolerances: $\pm 20\%$, $\pm 10\%$, $\pm 5\%$

Operating temperature range:
-55° C to +105° C (hot spot including self-heating)

Climatic test category: 55/085/56
in accordance with IEC

Dissipation factors at +20° C:

PCM	1 kHz	10 kHz
27.5	$\leq 15 \times 10^{-4}$	$\leq 160 \times 10^{-4}$
37.5	$\leq 30 \times 10^{-4}$	$\leq 210 \times 10^{-4}$
52.5	$\leq 50 \times 10^{-4}$	$\leq 260 \times 10^{-4}$

Voltage and current derating:

A derating factor of 1.35% per K must be applied from +85° C for DC voltages and from +70° C for AC currents (I_{rms}). Additionally a derating factor of 4.5% per K must be applied from +85° C for AC currents (I_{rms})

Reliability: Operational life > 100 000 hours (U_r and 70° C)

Failure rate λ_0 ($0.5 \times U_r$ and 40° C)

$\Pi = C_N [\mu\text{F}] \times U_r [\text{V}] $	λ_0
$\Pi \leq 10\,000$	< 2 fit
$10\,000 < \Pi \leq 25\,000$	< 5 fit
$25\,000 < \Pi \leq 50\,000$	< 10 fit
$50\,000 < \Pi \leq 100\,000$	< 20 fit
$\Pi > 100\,000$	< 30 fit

Maximum pulse rise time:

PCM	max. pulse rise time V/ μsec at $T_A < 40^\circ\text{C}$						
	400VDC	500VDC	600VDC	800VDC	900VDC	1100VDC	1300VDC
27.5	11	15	27	29	35	43	50
37.5	8	10	19	21	22	29	35
52.5	5	7	13	15	18	21	25

for pulses equal to the rated voltage

Insulation resistance at +20° C:

$\geq 30\,000 \text{ sec} (M\Omega \times \mu\text{F})$

(mean value: 100 000 sec)

Measuring voltage: 100 V/1 min.

Test voltage: 1.2 U_r , 2sec

Dielectric absorption: 0.05 %

Specific dissipation:

Box size WxHxL in mm	Specific dissipation in Watts per K above the ambient temperature
9x19x31.5	0.021
11x21x31.5	0.025
13x24x31.5	0.030
15x26x31.5	0.034
17x29x31.5	0.039
27x15x41.5	0.043
17x34.5x31.5	0.044
20x39.5x31.5	0.053
19x32x41.5	0.054
20x39.5x41.5	0.065
24x45.5x41.5	0.080
31x46x41.5	0.092
35x50x41.5	0.106
40x55x41.5	0.123
35x50x57	0.132
45x55x57	0.164
45x65x57	0.184

Packing

Packing units at the end of the catalogue

For further details and graphs please refer to Technical Information.

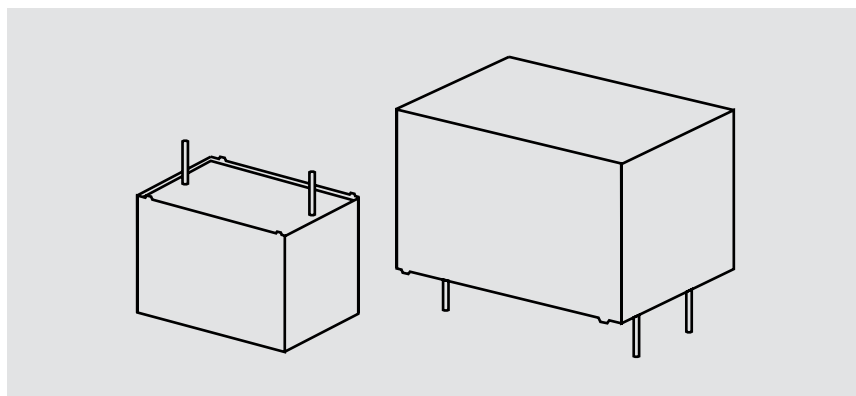

Continuation

General Data

Capacitance	400 VDC (70° C) / 300 VDC (85° C)					I_s A	I_{rms}^* (10 kHz)* A	ESR (10 kHz)* mΩ	Part number
	W	H	L	PCM**	Pin				
1 μF	9	19	31.5	27.5	2	11	1	238.7	DCP4G041006A
2 "	9	19	31.5	27.5	2	22	1.5	119.4	DCP4G042006A
3 "	9	19	31.5	27.5	2	33	1.5	79.6	DCP4G043006A
4 "	9	19	31.5	27.5	2	44	2	59.7	DCP4G044006A
5 "	9	19	31.5	27.5	2	55	2	47.7	DCP4G045006A
7 "	9	19	31.5	27.5	2	77	2.5	34.1	DCP4G047006A
10 μF	11	21	31.5	27.5	2/4	110	3.5	23.9	DCP4G051006B
15 "	13	24	31.5	27.5	2/4	165	4.5	15.9	DCP4G051506D
20 "	15	26	31.5	27.5	2/4	220	5.5	11.9	DCP4G052006F
25 "	17	29	31.5	27.5	2/4	275	6.5	9.5	DCP4G052506G
30 "	17	34.5	31.5	27.5	2/4	330	7	8	DCP4G053006I
40 "	20	39.5	31.5	27.5	2/4	440	9.5	6	DCP4G054006J
50 "	20	39.5	41.5	37.5	2/4	400	11	5.4	DCP4G055007G
60 "	20	39.5	41.5	37.5	2/4	480	11.5	4.8	DCP4G056007G
70 "	24	45.5	41.5	37.5	2/4	560	15	3.6	DCP4G057007H
80 "	24	45.5	41.5	37.5	2/4	640	17	2.7	DCP4G058007H
90 "	24	45.5	41.5	37.5	2/4	720	17.5	2.6	DCP4G059007H
100 μF	31	46	41.5	37.5	2/4	800	19	2.5	DCP4G061007I
120 "	31	46	41.5	37.5	2/4	960	20	2.3	DCP4G061207I
140 "	35	50	41.5	37.5	2/4	1120	22.5	2.1	DCP4G061407J
150 "	35	50	41.5	37.5	2/4	1200	23	2	DCP4G061507J
160 "	40	55	41.5	37.5	2/4	1280	28	1.6	DCP4G061607K
180 "	40	55	41.5	37.5	2/4	1440	29.5	1.4	DCP4G061807K
190 "	40	55	41.5	37.5	2/4	1520	31.5	1.2	DCP4G061907K
200 "	40	55	41.5	37.5	2/4	1600	32.5	1.2	DCP4G062007K
220 "	35	50	57	52.5	4	1100	27	1.8	DCP4G062209F
250 "	45	55	57	52.5	4	1250	32	1.6	DCP4G062509H
270 "	45	55	57	52.5	4	1350	33.5	1.5	DCP4G062709H
300 "	45	55	57	52.5	4	1500	35	1.3	DCP4G063009H
330 "	45	65	57	52.5	4	1650	37	1.2	DCP4G063309J
350 "	45	65	57	52.5	4	1750	40	1.1	DCP4G063509J
370 "	45	65	57	52.5	4	1850	41.5	1.1	DCP4G063709J
400 "	45	65	57	52.5	4	2000	43	1	DCP4G064009J

New voltage range

* General guide

* Permissible I_{rms} at 10° C internal temperature rise (general guide)

** PCM = Printed circuit module = pin spacing

Dims. in mm.

Part number completion:	
Version code:	2-pin = D2
	4-pin = D4
Tolerance:	20 % = M
	10 % = K
	5 % = J
Packing:	bulk = S
Pin length:	6-2 = SD
Taped version see page 145.	

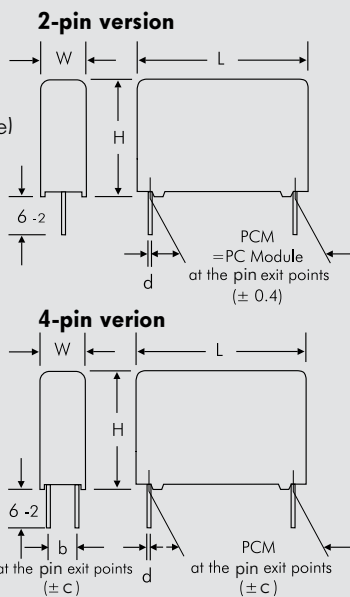

PCM	d
27.5	0.8
37.5	1

W	PCM	b	d	c
11	27.5	5	0.8	0.4
13	27.5	7.5	0.8	0.4
15	27.5	7.5	0.8	0.4
17	27.5	10	0.8	0.4
20	27.5	12.5	0.8	0.4
20	37.5	12.5	1	0.4
24	37.5	12.5	1	0.4
31	37.5	20	1	0.4
35	37.5	20	1	0.4
40	37.5	20	1	0.4
35	52.5	20	1.2	0.8
45	52.5	20	1.2	0.8

Rights reserved to amend design data without prior notification.

Continuation page 121



Continuation

General Data

Capacitance	500 VDC (70° C) / 400 VDC (85° C)					I _s A	I _{rms} * (10 kHz)* A	ESR (10 kHz)* mΩ	Part number
	W	H	L	PCM**	Pin				
1 μF	9	19	31.5	27.5	2	15	1	238.7	DCP4H141006A
2 "	9	19	31.5	27.5	2	30	1.5	119.4	DCP4H142006A
3 "	9	19	31.5	27.5	2	45	1.5	79.6	DCP4H143006A
5 "	9	19	31.5	27.5	2	75	2.5	47.7	DCP4H145006A
7 "	11	21	31.5	27.5	2/4	105	3	34.1	DCP4H147006B
8 "	13	24	31.5	27.5	2/4	120	3	29.8	DCP4H148006D
10 μF	13	24	31.5	27.5	2/4	150	4	23.9	DCP4H151006D
12 "	15	26	31.5	27.5	2/4	180	4	19.9	DCP4H151206F
15 "	17	29	31.5	27.5	2/4	225	5	15.9	DCP4H151506G
20 "	17	34.5	31.5	27.5	2/4	300	6	11.9	DCP4H152006I
22 "	20	39.5	31.5	27.5	2/4	330	7	10.9	DCP4H152206J
25 "	20	39.5	31.5	27.5	2/4	375	7.5	9.5	DCP4H152506J
30 "	20	39.5	41.5	37.5	2/4	300	9	7.9	DCP4H153007G
35 "	20	39.5	41.5	37.5	2/4	350	8.5	9.1	DCP4H153507G
40 "	20	39.5	41.5	37.5	2/4	400	10	5.7	DCP4H154007G
	24	45.5	41.5	37.5	2/4	400	10	8	DCP4H154007H
45 "	24	45.5	41.5	37.5	2/4	450	12.5	5	DCP4H154507H
50 "	24	45.5	41.5	37.5	2/4	500	13	4.8	DCP4H155007H
55 "	24	45.5	41.5	37.5	2/4	550	14	4	DCP4H155507H
60 "	31	46	41.5	37.5	2/4	600	14	4.7	DCP4H156007I
65 "	31	46	41.5	37.5	2/4	650	16.5	3.3	DCP4H156507I
70 "	31	46	41.5	37.5	2/4	700	18	2.9	DCP4H157007I
75 "	31	46	41.5	37.5	2/4	750	17	3.2	DCP4H157507I
80 "	31	46	41.5	37.5	2/4	800	18	2.8	DCP4H158007I
85 "	35	50	41.5	37.5	2/4	850	10.5	3.2	DCP4H158507J
90 "	35	50	41.5	37.5	2/4	900	21	2.4	DCP4H159007J
95 "	35	50	41.5	37.5	2/4	950	21.5	2.2	DCP4H159507J
100 μF	35	50	41.5	37.5	2/4	1000	24	1.9	DCP4H161007J
	35	50	57	52.5	4	700	18	4	DCP4H161009F
110 "	40	55	41.5	37.5	2/4	1100	19	2.9	DCP4H161107K
	35	50	57	52.5	4	770	19	3.6	DCP4H161109F
120 "	40	55	41.5	37.5	2/4	840	22.5	2.7	DCP4H161207K
	35	50	57	52.5	4	840	20	3.3	DCP4H161209F
130 "	40	55	41.5	37.5	2/4	910	23	2.4	DCP4H161307K
	35	50	57	52.5	4	910	21	3.1	DCP4H161309F
140 "	35	50	57	52.5	4	980	21.5	2.8	DCP4H161409F
150 "	35	50	57	52.5	4	1050	22.5	2.7	DCP4H161509F
160 "	45	55	57	52.5	4	1120	25.5	2.5	DCP4H161609H
170 "	45	55	57	52.5	4	1190	26.5	2.3	DCP4H161709H
180 "	45	55	57	52.5	4	1260	27	2.2	DCP4H161809H
190 "	45	55	57	52.5	4	1330	28	2.1	DCP4H161909H
200 "	45	55	57	52.5	4	1400	28.5	2	DCP4H162009H
210 "	45	55	57	52.5	4	1470	29.5	1.9	DCP4H162109H
220 "	45	65	57	52.5	4	1540	32	1.8	DCP4H162209J
240 "	45	65	57	52.5	4	1680	33.5	1.7	DCP4H162409J

New voltage range

* General guide

* Permissible I_{rms} at 10° C internal temperature rise (general guide)

** PCM = Printed circuit module = pin spacing

Dims. in mm.

Rights reserved to amend design data without prior notification.

Continuation

General Data

Capacitance	W	H	L	PCM**	Pin	600 VDC (70° C) / 450 VDC (85° C)			Part number
						I_S A	I_{rms} (10 kHz)* A	ESR (10 kHz)* mΩ	
2 μF	9	19	31.5	27.5	2	38	2	56	DCP41042006A
5 "	13	24	31.5	27.5	2/4	95	3.5	22	DCP41045006D
7 "	15	26	31.5	27.5	2/4	133	4.5	16	DCP41047006F
10 μF	17	29	31.5	27.5	2/4	190	6	11	DCP41051006G
	27	15	41.5	37.5	2/4	140	6.5	10	DCP41051007M
15 "	17	34.5	31.5	27.5	2/4	285	7.5	7.4	DCP41051506I
20 "	20	39.5	31.5	27.5	2/4	380	9	6.2	DCP41052006J
	20	39.5	41.5	37.5	2/4	280	10	6.2	DCP41052007G
25 "	20	39.5	41.5	37.5	2/4	350	11.5	5	DCP41052507G
30 "	24	45.5	41.5	37.5	2/4	420	14	4.1	DCP41053007H
35 "	24	45.5	41.5	37.5	2/4	490	14.5	3.8	DCP41053507H
40 "	31	46	41.5	37.5	2/4	560	16.5	3.3	DCP41054007I
45 "	31	46	41.5	37.5	2/4	630	17	3.2	DCP41054507I
50 "	35	50	41.5	37.5	2/4	700	19	2.9	DCP41055007J
55 "	35	50	41.5	37.5	2/4	770	17	3.8	DCP41055507J
60 "	35	50	41.5	37.5	2/4	840	17.5	3.4	DCP41056007J
65 "	40	55	41.5	37.5	2/4	910	19.5	3.3	DCP41056507K
	35	50	57	52.5	4	650	20	3.3	DCP41056509F
70 "	40	55	41.5	37.5	2/4	980	20	3.1	DCP41057007K
	35	50	57	52.5	4	700	20.5	3.1	DCP41057009F
75 "	40	55	41.5	37.5	2/4	1050	20.5	3	DCP41057507K
	35	50	57	52.5	4	750	21	3	DCP41057509F
80 "	40	55	41.5	37.5	2/4	1120	22	2.6	DCP41058007K
	35	50	57	52.5	4	800	22	2.6	DCP41058009F
85 "	35	50	57	52.5	4	850	22.5	2.1	DCP41058509F
90 "	35	50	57	52.5	4	900	23.5	1.9	DCP41059009F
95 "	45	55	57	52.5	4	950	24	2.8	DCP41059509H
100 μF	45	55	57	52.5	4	1000	25	2.6	DCP41061009H
110 "	45	55	57	52.5	4	1100	26.5	2.3	DCP41061109H
115 "	45	65	57	52.5	4	1150	27.5	2.5	DCP41061159J
120 "	45	65	57	52.5	4	1200	28	2.3	DCP41061209J
130 "	45	65	57	52.5	4	1300	29.5	2.1	DCP41061309J
140 "	45	65	57	52.5	4	1400	31	1.9	DCP41061409J
150 "	45	65	57	52.5	4	1500	33	1.7	DCP41061509J

* General guide

** PCM = Printed circuit module = pin spacing

Dims. in mm.

Part number completion:	
Version code:	2-pin = D2 4-pin = D4
Tolerance:	20 % = M 10 % = K 5 % = J
Packing:	bulk = S
Pin length:	6-2 = SD
Taped version see page 145.	

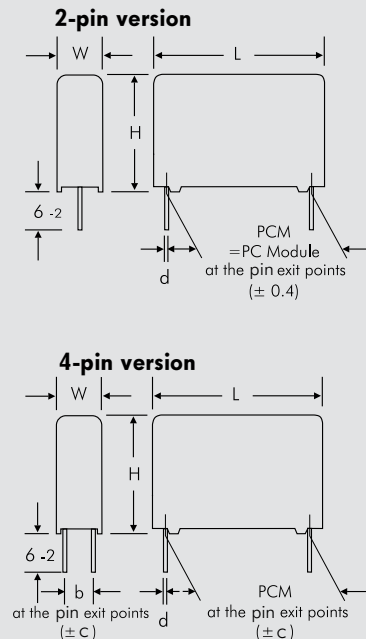

PCM	d
27.5	0.8
37.5	1

W	PCM	b	d	c
11	27.5	5	0.8	0.4
13	27.5	7.5	0.8	0.4
15	27.5	7.5	0.8	0.4
17	27.5	10	0.8	0.4
20	27.5	12.5	0.8	0.4
19	37.5	10	1	0.4
20	37.5	12.5	1	0.4
24	37.5	12.5	1	0.4
27	37.5	20	1	0.4
31	37.5	20	1	0.4
35	37.5	20	1	0.4
40	37.5	20	1	0.4
35	52.5	20	1.2	0.8
45	52.5	20	1.2	0.8

Rights reserved to amend design data without prior notification.

Continuation

General Data

Capacitance	800 VDC (70° C) / 700 VDC (85° C)					I_s A	I_{rms} (10 kHz)* A	ESR (10 kHz)* mΩ	Part number
	W	H	L	PCM**	Pin				
2 μF	9	19	31.5	27.5	2	42	2	52	DCP4L042006A
5 "	13	24	31.5	27.5	2/4	105	4	21	DCP4L045006D
7 "	17	29	31.5	27.5	2/4	147	5	15	DCP4L047006G
10 μF	17	34.5	31.5	27.5	2/4	210	6.5	10	DCP4L051006I
15 "	20	39.5	31.5	27.5	2/4	315	9	6.9	DCP4L051506J
	20	39.5	41.5	37.5	2/4	225	9.5	6.9	DCP4L051507G
20 "	20	39.5	41.5	37.5	2/4	300	10	6.2	DCP4L052007G
25 "	24	45.5	41.5	37.5	2/4	375	12.5	5	DCP4L052507H
30 "	24	45.5	41.5	37.5	2/4	450	14	4.1	DCP4L053007H
35 "	31	46	41.5	37.5	2/4	525	15.5	3.8	DCP4L053507I
40 "	31	46	41.5	37.5	2/4	600	16.5	3.3	DCP4L054007I
45 "	35	50	41.5	37.5	2/4	675	17.5	3.4	DCP4L054507J
50 "	35	50	41.5	37.5	2/4	750	19	3	DCP4L055007J
55 "	40	55	41.5	37.5	2/4	825	19.5	3.2	DCP4L055507K
	35	50	57	52.5	4	660	20.4	3.2	DCP4L055509F
60 "	40	55	41.5	37.5	2/4	900	20.5	2.9	DCP4L056007K
	35	50	57	52.5	4	720	21.5	2.9	DCP4L056009F
65 "	35	50	57	52.5	4	780	22.5	2.2	DCP4L056509F
70 "	45	55	57	52.5	4	840	23.5	3	DCP4L057009H
75 "	45	55	57	52.5	4	900	24	2.9	DCP4L057509H
80 "	45	55	57	52.5	4	960	24.5	3	DCP4L058009H
85 "	45	65	57	52.5	4	1020	25	2.6	DCP4L058509J
90 "	45	65	57	52.5	4	1080	25.5	2.5	DCP4L059009J
95 "	45	65	57	52.5	4	1140	26	2.4	DCP4L059509J
100 μF	45	65	57	52.5	4	1200	26.5	2.3	DCP4L061009J
110 "	45	65	57	52.5	4	1320	27.5	2.2	DCP4L061109J
115 "	45	65	57	52.5	4	1380	28	2.1	DCP4L061159J

Capacitance	900 VDC (70° C) / 760 VDC (85° C)					I_s A	I_{rms} (10 kHz)* A	ESR (10 kHz)* mΩ	Part number
	W	H	L	PCM**	Pin				
2 μF	11	21	31.5	27.5	2/4	50	2.5	44	DCP4N042006B
5 "	17	29	31.5	27.5	2/4	125	4.5	18	DCP4N045006G
7 "	17	34.5	31.5	27.5	2/4	175	6	13	DCP4N047006I
10 μF	20	39.5	31.5	27.5	2/4	250	8	8.8	DCP4N051006J
	20	39.5	41.5	37.5	2/4	160	8.5	8.8	DCP4N051007G
15 "	20	39.5	41.5	37.5	2/4	240	10.5	5.8	DCP4N051507G
20 "	24	45.5	41.5	37.5	2/4	320	13	4.8	DCP4N052007H
25 "	31	46	41.5	37.5	2/4	400	15.5	3.8	DCP4N052507I
30 "	31	46	41.5	37.5	2/4	480	15.5	3.7	DCP4N053007I
35 "	35	50	41.5	37.5	2/4	560	18	3.2	DCP4N053507J
40 "	40	55	41.5	37.5	2/4	640	19.5	3.2	DCP4N054007K
	35	50	57	52.5	4	520	20.5	3.2	DCP4N054009F
45 "	35	50	57	52.5	4	585	21	2.8	DCP4N054509F
50 "	35	50	57	52.5	4	650	22	3.3	DCP4N055009F
55 "	35	50	57	52.5	4	715	22.5	3.2	DCP4N055509F
	45	55	57	52.5	4	715	22.5	3.2	DCP4N055509H
60 "	45	55	57	52.5	4	780	23	3	DCP4N056009H
65 "	45	55	57	52.5	4	845	24	2.9	DCP4N056509H
70 "	45	65	57	52.5	4	910	24.5	3.3	DCP4N057009J
75 "	45	65	57	52.5	4	975	25	2.9	DCP4N057509J
80 "	45	65	57	52.5	4	1040	25.5	2.8	DCP4N058009J

* General guide

** PCM = Printed circuit module = pin spacing

Dims. in mm.

Rights reserved to amend design data without prior notification.

Continuation

General Data

Capacitance	W	H	L	PCM**	Pin	1100 VDC (70° C) / 920 VDC (85° C)			Part number
						I_s A	I_{rms} (10 kHz)* A	ESR (10 kHz)* mΩ	
2 μF	13	24	31.5	27.5	2/4	62	3	36	DCP4P042006D
3 "	15	26	31.5	27.5	2/4	129	4	23	DCP4P043006F
5 "	17	34.5	31.5	27.5	2/4	155	5.5	14	DCP4P045006I
7 "	20	39.5	31.5	27.5	2/4	217	7.5	10	DCP4P047006J
	19	32	41.5	37.5	2/4	147	7.5	10	DCP4P047007F
10 μF	20	39.5	41.5	37.5	2/4	210	9.5	7.2	DCP4P051007G
15 "	31	46	41.5	37.5	2/4	315	13	5.4	DCP4P051507I
20 "	31	46	41.5	37.5	2/4	420	14	5.2	DCP4P052007I
	35	50	41.5	37.5	2/4	420	15	4.7	DCP4P052007J
25 "	40	55	41.5	37.5	2/4	525	16.5	4.6	DCP4P052507K
30 "	35	50	57	52.5	4	450	17.5	4.4	DCP4P053009F
35 "	35	50	57	52.5	4	525	18	4	DCP4P053509F
40 "	45	55	57	52.5	4	600	19	4.5	DCP4P054009H
45 "	45	55	57	52.5	4	675	20	4.1	DCP4P054509H
50 "	45	65	57	52.5	4	750	21	4.1	DCP4P055009J
55 "	45	65	57	52.5	4	825	22	3.8	DCP4P055509J
60 "	45	65	57	52.5	4	900	23	3.5	DCP4P056009J

Capacitance	W	H	L	PCM**	Pin	1300 VDC (70° C) / 1100 VDC (85° C)			Part number
						I_s A	I_{rms} (10 kHz)* A	ESR (10 kHz)* mΩ	
2 μF	15	26	31.5	27.5	2/4	72	3	36	DCP4R242006F
5 "	20	39.5	31.5	27.5	2/4	180	6	14	DCP4R245006J
	20	39.5	41.5	37.5	2/4	125	7	14	DCP4R245007G
7 "	20	39.5	41.5	37.5	2/4	175	8	10	DCP4R247007G
10 μF	24	45.5	41.5	37.5	2/4	250	10.5	7.2	DCP4R251007H
15 "	31	46	41.5	37.5	2/4	375	14	4.8	DCP4R251507I
20 "	40	55	41.5	37.5	2/4	500	17.5	4	DCP4R252007K
	35	50	57	52.5	4	360	18	4	DCP4R252009F
25 "	35	50	57	52.5	4	450	19	3.6	DCP4R252509F
30 "	45	55	57	52.5	4	540	20	4	DCP4R253009H
35 "	45	65	57	52.5	4	630	21	4.1	DCP4R253509J
40 "	45	65	57	52.5	4	720	22	3.7	DCP4R254009J

* General guide

** PCM = Printed circuit module = pin spacing

Dims. in mm.

Part number completion:	
Version code:	2-pin = D2 4-pin = D4
Tolerance:	20 % = M 10 % = K 5 % = J
Packing:	bulk = S
Pin length:	6-2 = SD
Taped version see page 145.	

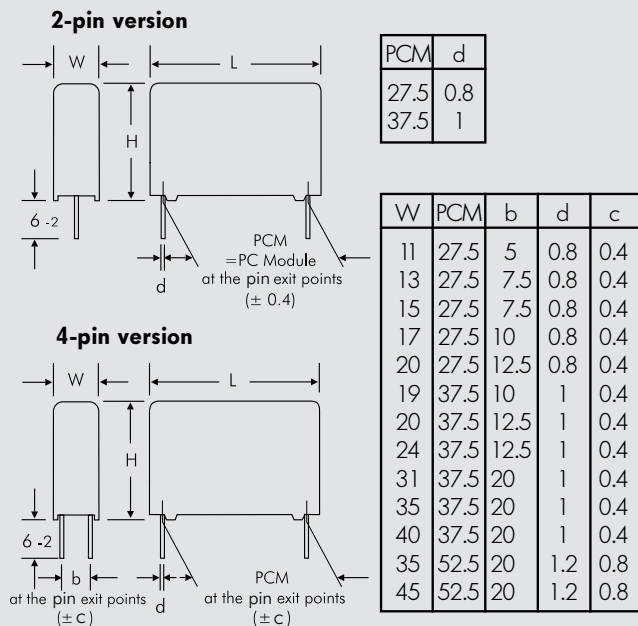

Rights reserved to amend design data without prior notification.

Metallized Polypropylene (PP) - DC-Link Capacitors for STRINGENT REQUIREMENTS. Capacitances from 0.47 μF to 80 μF . Rated Voltages from 450 VDC to 1050 VDC.

Special Features

- Capacitances up to 80 μF
- High volume/capacitance ratio
- Excellent self-healing properties
- For stringent requirements
- Very low dissipation factor
- High reliability
- 2-pin and 4-pin contact configuration (plate versions on request)
- According to RoHS 2011/65/EU

Typical Applications

As intermediate circuit capacitor e.g. in high power converter technology, power supplies, solar inverters etc.

Construction

Dielectric:

Polypropylene (PP) film

Capacitor electrodes:

Vacuum-deposited

Internal construction:

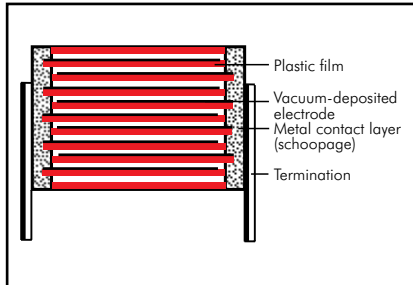

Encapsulation:

Solvent-resistant, flame-retardant plastic case with epoxy resin seal, UL 94 V-0

Terminations:

Tinned wire (plate versions on request).

Marking:

Colour: Red. Marking: Black.

Epoxy resin seal: Red

Electrical Data

Capacitance range: 0.47 μF to 80 μF (intermediate values on request)

Rated voltages: 450 VDC, 630 VDC, 800 VDC, 900 VDC, 1050 VDC

Capacitance tolerances: $\pm 20\%$, $\pm 10\%$, $\pm 5\%$

Operating temperature range: -55°C to $+105^\circ\text{C}$ (hot spot including self-heating)

Climatic test category: 55/085/56 in accordance with IEC

Dissipation factors at $+20^\circ\text{C}$:

PCM	1 kHz
27.5	$\leq 12 \times 10^{-4}$
37.5	$\leq 25 \times 10^{-4}$
52.5	$\leq 45 \times 10^{-4}$

Voltage and current derating:

A derating factor of 1.35% per K must be applied from $+85^\circ\text{C}$ for DC voltages and from $+70^\circ\text{C}$ for AC currents (I_{rms}). Additionally a derating factor of 4.5% per K must be applied from $+85^\circ\text{C}$ for AC currents (I_{rms})

Reliability: Operational life $> 100\,000$ hours (U_r and 70°C)

Failure rate λ_0 ($10.5 \times U_r$ and 40°C)

$\Pi = C_N [\mu\text{F}] \times U_r [\text{V}] $	λ_0
$\Pi \leq 10\,000$	< 2 fit
$10\,000 < \Pi \leq 25\,000$	< 5 fit
$25\,000 < \Pi \leq 50\,000$	< 10 fit
$50\,000 < \Pi \leq 100\,000$	< 20 fit
$\Pi > 100\,000$	< 30 fit

Maximum pulse rise time:

PCM	max. pulse rise time V/ μsec at $T_A < 40^\circ\text{C}$				
	450 VDC	630 VDC	800 VDC	900 VDC	1050 VDC
27.5	48	59	71	81	93
37.5	32	41	51	60	69
52.5	27	32	37	43	48

for pulses equal to the rated voltage

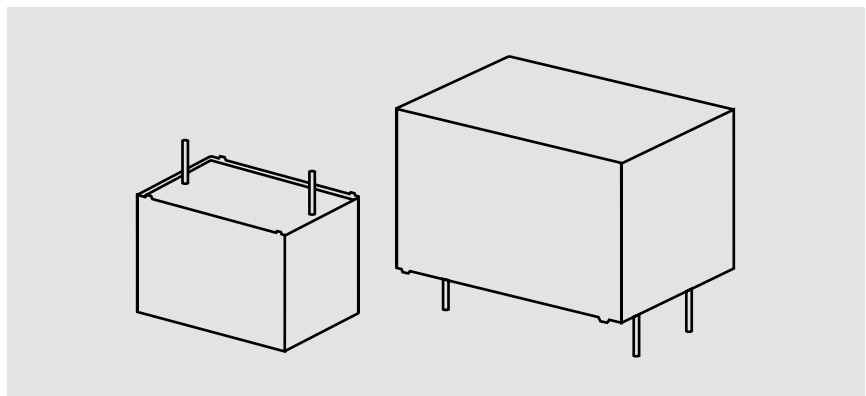

Insulation resistance at $+20^\circ\text{C}$:

$\geq 30\,000$ sec ($M\Omega \times \mu\text{F}$)

(mean value: $100\,000$ sec)

Measuring voltage: $100\text{ V}/1\text{ min}$.

Test voltage: $1.6 U_r$, 2sec

Dielectric absorption: 0.05 %

Specific dissipation:

Box size WxHxL in mm	Specific dissipation in Watts per K above the ambient temperature
11 x 21 x 31.5	0.025
13 x 24 x 31.5	0.030
15 x 26 x 31.5	0.034
17 x 29 x 31.5	0.039
17 x 34.5 x 31.5	0.044
20 x 39.5 x 31.5	0.053
15 x 26 x 41.5	0.042
17 x 29 x 41.5	0.048
19 x 32 x 41.5	0.054
20 x 39.5 x 41.5	0.065
24 x 45.5 x 41.5	0.080
31 x 46 x 41.5	0.092
35 x 50 x 41.5	0.106
40 x 55 x 41.5	0.123
35 x 50 x 57	0.132
45 x 55 x 57	0.164
45 x 65 x 57	0.184

Packing

Packing units at the end of the catalogue.

For further details and graphs please refer to Technical Information.



Continuation

General Data

Capacitance	W	H	L	PCM**	Pin	450 VDC (70° C) / 300 VDC (85° C)				Part number
						I _s A	I _{rms} (10 kHz)*		ESR (10 kHz)* mΩ	
							10 K	20 K		
2.2 μF	11	21	31.5	27.5	2/4	106	4.3	6.1	13.7	DCPSH042206B
3.3 "	13	24	31.5	27.5	2/4	158	5.3	7.5	10.6	DCPSH043306D
4.7 "	15	26	31.5	27.5	2/4	226	6.2	8.8	8.8	DCPSH044706F
6.8 "	17	29	31.5	27.5	2/4	326	7.4	10.5	7.1	DCPSH046806G
10 μF	19	32	41.5	37.5	2/4	320	9.6	13.6	5.9	DCPSH051007F
15 "	20	39.5	41.5	37.5	2/4	480	11.8	16.7	4.7	DCPSH051507G
20 "	24	45.5	41.5	37.5	2/4	640	13.9	19.7	4.1	DCPSH052007H
25 "	31	46	41.5	37.5	2/4	800	15.5	21.9	3.8	DCPSH052507I
30 "	31	46	41.5	37.5	2/4	960	16.3	23.0	3.5	DCPSH053007I
35 "	35	50	41.5	37.5	2/4	1120	18.3	25.8	3.2	DCPSH053507J
40 "	40	55	41.5	37.5	2/4	1280	20.3	28.7	3.0	DCPSH054007K
	35	50	57	52.5	4	1080	21.0	29.7	3.0	DCPSH054009F
45 "	35	50	57	52.5	4	1215	21.7	30.7	2.8	DCPSH054509F
50 "	35	50	57	52.5	4	1350	22.4	31.7	2.6	DCPSH055009F
55 "	45	55	57	52.5	4	1485	25.4	35.9	2.5	DCPSH055509H
60 "	45	55	57	52.5	4	1620	26.0	36.8	2.4	DCPSH056009H
65 "	45	55	57	52.5	4	1755	26.3	37.2	2.4	DCPSH056509H
70 "	45	65	57	52.5	4	1890	28.2	39.8	2.3	DCPSH057009J
75 "	45	65	57	52.5	4	2025	28.6	40.4	2.3	DCPSH057509J
80 "	45	65	57	52.5	4	2160	29.0	41.0	2.2	DCPSH058009J

Capacitance	W	H	L	PCM**	Pin	630 VDC (70° C) / 450 VDC (85° C)				Part number
						I _s A	I _{rms} (10 kHz)*		ESR (10 kHz)* mΩ	
							10 K	20 K		
1.5 μF	11	21	31.5	27.5	2/4	89	3.8	5.4	17.0	DCPSJ041506B
2.2 "	13	24	31.5	27.5	2/4	130	4.7	6.6	13.7	DCPSJ042206D
3.3 "	15	26	31.5	27.5	2/4	195	5.7	8.0	10.6	DCPSJ043306F
4.7 "	17	34.5	31.5	27.5	2/4	277	7.1	10.0	8.8	DCPSJ044706L
6.8 "	17	29	41.5	37.5	2/4	279	8.2	11.6	7.1	DCPSJ046807E
10 μF	20	39.5	41.5	37.5	2/4	410	10.5	14.8	5.9	DCPSJ051007G
15 "	31	46	41.5	37.5	2/4	615	14.0	19.8	4.7	DCPSJ051507I
20 "	35	50	41.5	37.5	2/4	820	16.0	22.6	4.1	DCPSJ052007J
25 "	40	55	41.5	37.5	2/4	1025	18.0	25.5	3.8	DCPSJ052507K
30 "	35	50	57	52.5	4	960	19.6	27.7	3.5	DCPSJ053009F
35 "	35	50	57	52.5	4	1120	20.4	28.8	3.1	DCPSJ053509F
40 "	45	55	57	52.5	4	1280	23.4	33.1	3.0	DCPSJ054009H
45 "	45	55	57	52.5	4	1440	25.5	36.1	2.8	DCPSJ054509H
50 "	45	65	57	52.5	4	1600	26.4	37.3	2.6	DCPSJ055009J
55 "	45	65	57	52.5	4	1760	26.9	38.0	2.5	DCPSJ055509J
60 "	45	65	57	52.5	4	1920	27.5	38.8	2.4	DCPSJ056009J

* General guide.

** PCM = Printed circuit module = pin spacing

Dims. in mm.

Part number completion:

Version code:	2-pin	= D2
	4-pin	= D4
Tolerance:	20 %	= M
	10 %	= K
	5 %	= J
Packing:	bulk	= S
Pin length:	6-2	= SD
Taped version see page 145.		

Rights reserved to amend design data without prior notification.

Continuation page 127

Continuation

General Data

Capacitance	W	H	L	PCM**	Pin	800 VDC (70° C) / 630 VDC (85° C)				Part number
						I_s A	I_{rms} (10 kHz)* A		ESR (10 kHz)* mΩ	
							10 K	20 K		
1.0 μF	11	21	31.5	27.5	2/4	71	3.3	4.6	23.1	DCPSL041006B_
1.5 "	13	24	31.5	27.5	2/4	107	4.2	5.9	17.0	DCPSL041506D_
2.2 "	15	26	31.5	27.5	2/4	156	5.0	7.0	13.7	DCPSL042206F_
3.3 "	17	29	31.5	27.5	2/4	234	6.1	8.5	10.6	DCPSL043306G_
4.7 "	19	32	41.5	37.5	2/4	240	7.8	11.0	8.8	DCPSL044707F_
6.8 "	20	39.5	41.5	37.5	2/4	347	9.5	13.5	7.1	DCPSL046807G_
10 μF	24	45.5	41.5	37.5	2/4	510	11.7	16.4	5.9	DCPSL051007H_
15 "	31	46	41.5	37.5	2/4	765	14.0	19.8	4.7	DCPSL051507I_
20 "	40	55	41.5	37.5	2/4	1020	17.2	24.3	4.1	DCPSL052007K_
	35	50	57	52.5	4	740	17.9	25.2	4.1	DCPSL052009F_
25 "	35	50	57	52.5	4	925	18.6	26.2	3.8	DCPSL052509F_
30 "	45	55	57	52.5	4	1110	21.8	30.8	3.5	DCPSL053009H_
35 "	45	65	57	52.5	4	1295	24.0	33.9	3.2	DCPSL053509J_
40 "	45	65	57	52.5	4	1480	24.8	35.0	3.0	DCPSL054009J_

Capacitance	W	H	L	PCM**	Pin	900 VDC (70° C) / 750 VDC (85° C)				Part number
						I_s A	I_{rms} (10 kHz)* A		ESR (10 kHz)* mΩ	
							10 K	20 K		
0.68 μF	11	21	31.5	27.5	2/4	55	2.8	3.9	32.8	DCPSN036806B_
1.0 μF	13	24	31.5	27.5	2/4	81	3.6	5.1	23.1	DCPSN041006D_
1.5 "	15	26	31.5	27.5	2/4	122	4.5	6.3	17.0	DCPSN041506F_
2.2 "	17	29	31.5	27.5	2/4	178	5.3	7.5	13.7	DCPSN042206G_
3.3 "	17	29	41.5	37.5	2/4	198	6.7	9.5	10.6	DCPSN043307E_
4.7 "	20	39.5	41.5	37.5	2/4	282	8.6	12.1	8.8	DCPSN044707G_
6.8 "	24	45.5	41.5	37.5	2/4	408	10.6	15.0	7.1	DCPSN046807H_
10 μF	31	46	41.5	37.5	2/4	600	12.5	17.7	5.9	DCPSN051007I_
15 "	40	55	41.5	37.5	2/4	900	16.2	22.9	4.7	DCPSN051507K_
20 "	35	50	57	52.5	4	860	17.9	25.3	4.1	DCPSN052009F_
25 "	45	55	57	52.5	4	1075	20.7	29.3	3.8	DCPSN052509H_

* General guide

** PCM = Printed circuit module = pin spacing

Dims. in mm.

Part number completion:	
Version code:	2-pin = D2 4-pin = D4
Tolerance:	20 % = M 10 % = K 5 % = J
Packing:	bulk = S
Pin length:	6-2 = SD
Taped version see page 145.	

Rights reserved to amend design data without prior notification.

Continuation page 128

Continuation

General Data

Capacitance	W	H	L	PCM**	Pin	1050 VDC (70° C) / 875 VDC (85° C)				Part number
						I_s A	I_{rms} (10 kHz)* A		ESR (10 kHz)* mΩ	
							10 K	20 K		
0.47 μF	11	21	31.5	27.5	2/4	44	2.4	3.4	44.0	DCPSO334706B_____
0.68 "	11	21	31.5	27.5	2/4	63	2.8	3.9	32.8	DCPSO336806B_____
1.0 μF	13	24	31.5	27.5	2/4	93	3.6	5.1	23.1	DCPSO341006D_____
1.5 "	17	29	31.5	27.5	2/4	140	4.8	6.8	17.0	DCPSO341506G_____
	15	26	41.5	37.5	2/4	104	5.0	7.0	17.0	DCPSO341507D_____
2.2 "	17	34.5	31.5	27.5	2/4	205	5.7	8.0	13.7	DCPSO342206L_____
	17	29	41.5	37.5	2/4	152	5.9	8.4	13.7	DCPSO342207E_____
3.3 "	20	39.5	31.5	27.5	2/4	307	7.1	10.0	10.6	DCPSO343306J_____
	19	32	41.5	37.5	2/4	228	7.1	10.1	10.6	DCPSO343307F_____
4.7 "	20	39.5	41.5	37.5	2/4	324	8.6	12.1	8.8	DCPSO344707G_____
6.8 "	31	46	41.5	37.5	2/4	469	11.4	16.0	7.1	DCPSO346807L_____
10 μF	35	50	41.5	37.5	2/4	690	13.4	19.0	5.9	DCPSO351007J_____
15 "	35	50	57	52.5	4	720	16.8	23.8	4.7	DCPSO351509F_____
20 "	45	55	57	52.5	4	960	19.9	28.2	4.1	DCPSO352009H_____

* General guide

** PCM = Printed circuit module = pin spacing

Dims. in mm.

2-pin version

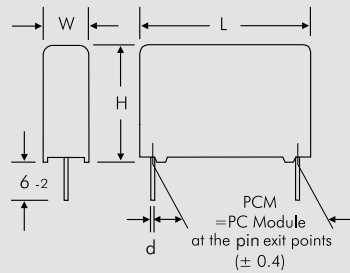

PCM	d
27.5	0.8
37.5	1

4-pin version

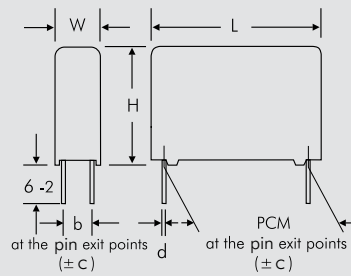

W	PCM	b	d	c
11	27.5	5	0.8	0.4
13	27.5	7.5	0.8	0.4
15	27.5	7.5	0.8	0.4
17	27.5	10	0.8	0.4
20	27.5	12.5	0.8	0.4
17	37.5	10	1	0.4
19	37.5	10	1	0.4
20	37.5	12.5	1	0.4
24	37.5	12.5	1	0.4
31	37.5	20	1	0.4
35	37.5	20	1	0.4
40	37.5	20	1	0.4
35	52.5	20	1.2	0.8
45	52.5	20	1.2	0.8

Part number completion:

Version code:	2-pin	= D2
	4-pin	= D4
Tolerance:	20 %	= M
	10 %	= K
	5 %	= J
Packing:	bulk	= S
Pin length:	6-2	= SD
Taped version see page 145.		

Rights reserved to amend design data without prior notification.

Metallized Polypropylene (PP) - Capacitors in Cylindrical Case for DC-Link Applications. Capacitances from 16 μF to 260 μF . Rated Voltages from 500 VDC to 1300 VDC.

Special Features

- Very high volume/capacitance ratio
- Self-healing properties
- With cylindrical plastic case for PCB mounting
- Dry construction without electrolyte or oil
- No internal fuse required
- Negative capacitance change versus temperature
- Very low dielectric absorption
- According to RoHS 2011/65/EU
- Customer-specific capacitances or voltages on request

Typical Applications

DC capacitors with high capacitances for applications in power electronics also at non-sinusoidal voltages and currents e.g. in

- Wind power systems
- Inverters

Construction

Dielectric:

Polypropylene (PP) film

Capacitor electrodes:

Vacuum-deposited

Internal construction:



Encapsulation:

Solvent-resistant, flame-retardant plastic case with PU-sealing, UL 94 V-0

Terminations:

Tinned wire.

Marking:

Colour: Grey. Marking: Black on silver label.

Electrical Data

Capacitance range: 16 μF to 260 μF

Rated voltages: 500 VDC, 700 VDC, 900 VDC, 1100 VDC, 1300 VDC

Capacitance tolerances: $\pm 20\%$, $\pm 10\%$ ($\pm 5\%$ available subject to special enquiry)

Operating temperature range:

-40°C to $+85^\circ\text{C}$

Insulation resistance at $+20^\circ\text{C}$:

≥ 5000 sec ($\text{M}\Omega \times \mu\text{F}$)

(mean value: 20000 sec)

Measuring voltage: 100 V/1 min.

Dielectric loss factor $\tan \delta_0$:
 2×10^{-4}

Test voltage: $1.5 U_r$, 2sec

Dielectric absorption:

0.05 %

Reliability:

Operational life > 100 000 hours

Failure rate < 50 fit (hot spot $\leq 70^\circ\text{C}$)

Mounting Recommendation

Excessive mechanical strain, e.g. pressure or shock onto the capacitor body, is to be avoided during mounting and usage of the capacitors.

Packing

Transportation-safe packing in cardboard boxes.

For further details and graphs please refer to Technical Information.

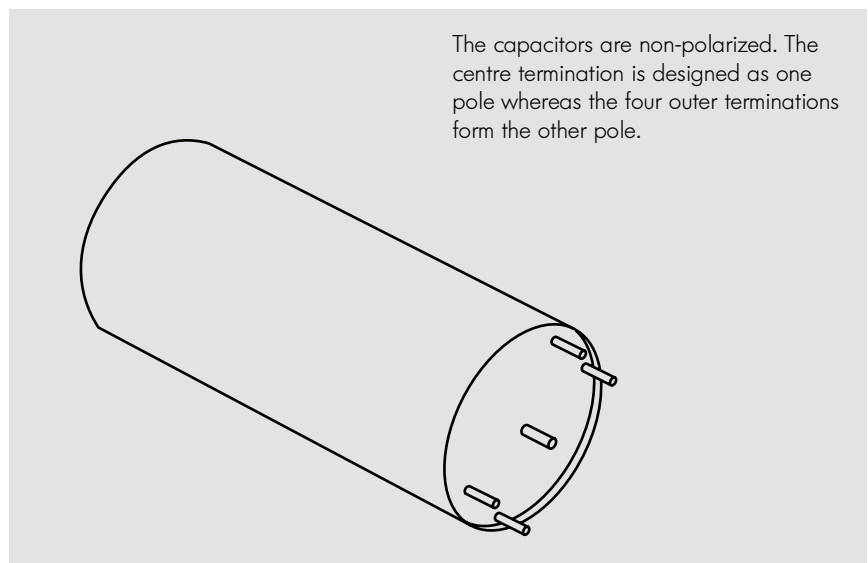

The capacitors are non-polarized. The centre termination is designed as one pole whereas the four outer terminations form the other pole.

Continuation

General Data

U_R	C_N	D x L mm	I_{rms} (1 kHz)* A	ESR (1 kHz)* m Ω	R_{th} K/W	L_e nH	Approx. weight g	Part number
500 VDC	85 μ F	50 x 57	35	2.0	11.0	< 45	120	DCP5H15850D000_
	195 "	50 x 95	32	3.4	7.5	< 65	190	DCP5H16195D100_
	260 "	50 x 120	30	5.2	6.0	< 85	220	DCP5H16260D200_
700 VDC	59 μ F	50 x 57	30	1.9	11.0	< 45	120	DCP5K05590D000_
	143 "	50 x 95	32	3.5	7.5	< 65	190	DCP5K06143D100_
	190 "	50 x 120	25	4.7	6.0	< 85	220	DCP5K06190D200_
900 VDC	53 μ F	50 x 57	35	2.3	11.0	< 45	120	DCP5N05530D000_
	114 "	50 x 95	32	4.2	7.5	< 65	190	DCP5N06114D100_
	158 "	50 x 120	30	6.0	6.0	< 85	220	DCP5N06158D200_
1100 VDC	30 μ F	50 x 57	20	2.8	11.0	< 45	120	DCP5P05300D000_
	72 "	50 x 95	25	4.5	7.5	< 65	190	DCP5P05720D100_
	100 "	50 x 120	25	6.1	6.0	< 85	220	DCP5P06100D200_
1300 VDC	16 μ F	50 x 57	20	3.0	11.0	< 45	120	DCP5R25160D000_
	40 "	50 x 95	25	5.7	7.5	< 65	190	DCP5R25400D100_
	55 "	50 x 120	25	7.7	6.0	< 85	220	DCP5R25550D200_

Contacts can handle: peak currents \hat{I} up to 1.1 kA
surge currents I_S up to 3.5 kA

Customer-specific capacitances or voltages on request

* General guide

Dims. in mm.

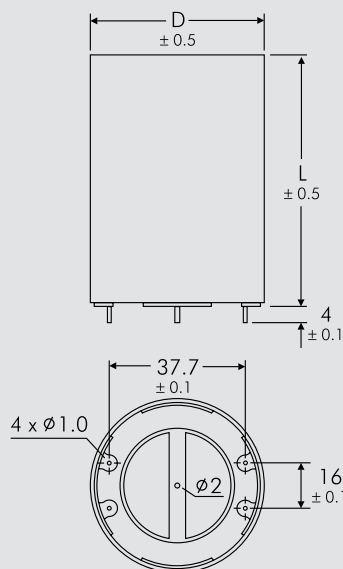

D	L
50	57
50	95
50	120

Part number completion:

Tolerance: 20 % = M
10 % = K
5 % = J
Packing: bulk = S
Pin length: none = 00

Rights reserved to amend design data without prior notification.

**Metallized Polypropylene (PP) - Capacitors in Cylindrical Case.
MKP 6 with High Volume/Capacitance Ratio, MKP 6 HP with Higher Current Carrying
Capability. Capacitances from 75 µF to 4920 µF. Rated Voltages from 600 VDC to 1500 VDC.**

Special Features

- Very high volume/capacitance ratio
- Self-healing properties
- With cylindrical aluminium case for bus bar mounting
- Dry construction without electrolyte or oil
- No internal fuse required
- Negative capacitance change versus temperature
- Very low dielectric absorption
- According to RoHS 2011/65/EU
- Customer-specific capacitances or voltages on request

Typical Applications

DC capacitors with high capacitances for applications in power electronics also at non-sinusoidal voltages and currents e.g. in

- Wind power systems
- Inverters

Construction

Dielectric:

Polypropylene (PP) film

Capacitor electrodes:

Vacuum-deposited

Internal construction:

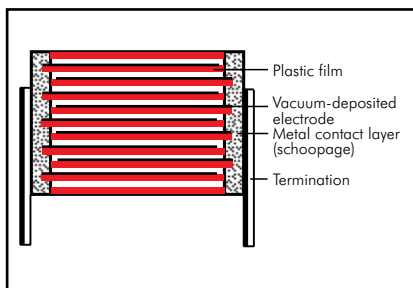

Encapsulation:

Aluminium case with PU-sealing, UL 94 V-0

Terminations:

Screw connection (male or female), screw bolt M12 x 16.

Marking:

Colour: Metallic. Marking: Black on silver label.

Electrical Data

Capacitance range: 75 µF to 4920 µF
Rated voltages: 600 VDC, 700 VDC, 900 VDC, 1100 VDC, 1300 VDC, 1500 VDC
Capacitance tolerances: ±20%, ±10% (±5% available subject to special enquiry)
Operating temperature range: -40° C to +85° C
Insulation resistance at +20° C:
 ≥ 5000 sec (MΩ x µF)
 (mean value: 20 000 sec)
 Measuring voltage: 100 V/1 min.

Dielectric loss factor

$\tan \delta_0: 2 \times 10^{-4}$

Test voltage between terminals

at +25° C: $1.5 U_{rDC}, 10\text{sec}$

Test voltage between terminals and case

at +25° C and 50 Hz: $3 kV_{AC}, 1 \text{ min.}$

Dielectric absorption:

0.05 %

Reliability:

Operational life > 100 000 hours

Failure rate < 50 fit (hot spot ≤ 70° C)

Mounting Recommendation

Excessive mechanical strain, e.g. pressure or shock onto the capacitor body, is to be avoided during mounting and usage of the capacitors.

Packing

Transportation-safe packing in cardboard boxes.

For further details and graphs please refer to Technical Information.

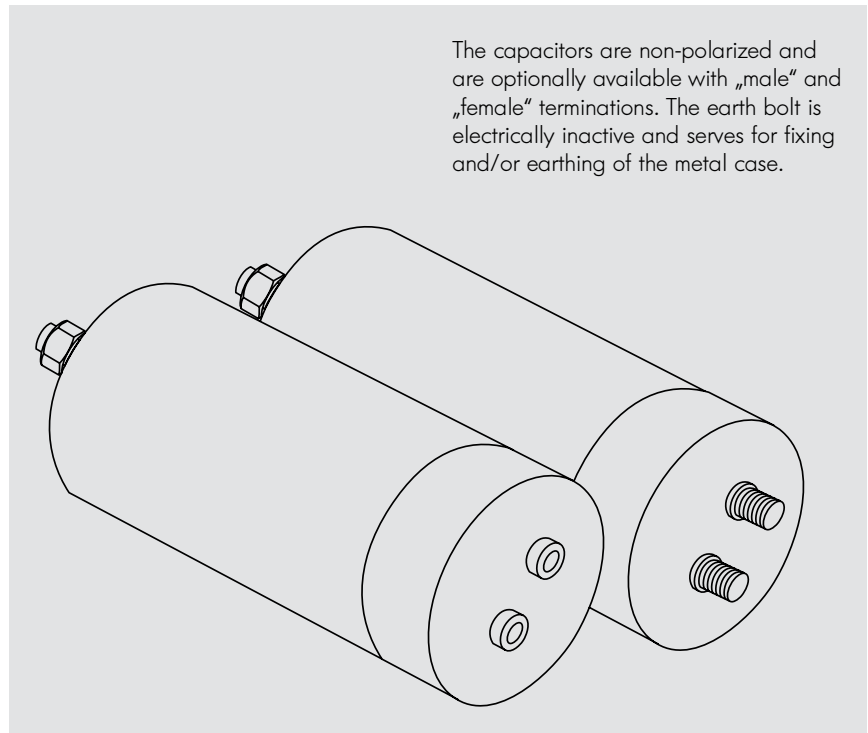



Continuation

General Data

U_R		C_N	D x L mm	I_{rms} (max.)* at 70°C A	ESR (1 kHz)* mΩ	L_e nH	Approx. weight g	Part number
70° C	85° C							
600 VDC	450 VDC	320 μ F	85 x 60	25	2.1	< 40	380	DCP6I06320EB00_
		460 "	85 x 76	25	2.1	< 40	480	DCP6I06460EC00_
		520 "	85 x 85	30	2.0	< 40	540	DCP6I06520ED00_
		620 "	85 x 95	30	1.9	< 40	600	DCP6I06620EE00_
		760 "	85 x 110	30	1.7	< 40	690	DCP6I06760EF00_
		780 "	85 x 120	30	1.7	< 40	700	DCP6I06780E000_
		950 "	85 x 132	35	1.8	< 40	850	DCP6I06950E100_
		1030 "	85 x 140	35	1.8	< 40	880	DCP6I07103EG00_
		1220 "	116 x 95	40	1.7	< 40	1200	DCP6I07122EN00_
		1500 "	116 x 110	40	1.7	< 40	1390	DCP6I07150EO00_
		1640 "	116 x 120	40	1.6	< 40	1510	DCP6I07164EP00_
		1890 "	116 x 132	40	1.6	< 40	1660	DCP6I07189EQ00_
2030 "	116 x 140	40	1.6	< 40	1760	DCP6I07203ER00_		
700 VDC	600 VDC	230 μ F	85 x 60	25	1.9	< 40	380	DCP6K06230EB00_
		330 "	85 x 76	25	1.9	< 40	480	DCP6K06330EC00_
		380 "	85 x 85	30	1.7	< 40	540	DCP6K06380ED00_
		450 "	85 x 95	30	1.7	< 40	600	DCP6K06450EE00_
		550 "	85 x 110	30	1.8	< 40	690	DCP6K06550EF00_
		585 "	85 x 120	30	1.8	< 40	700	DCP6K06585E000_
		690 "	85 x 132	35	1.8	< 40	850	DCP6K06690E100_
		740 "	85 x 140	35	1.8	< 40	880	DCP6K06740EG00_
		890 "	116 x 95	40	1.7	< 40	1200	DCP6K06890EN00_
		1090 "	116 x 110	40	1.7	< 40	1390	DCP6K07109EO00_
		1190 "	116 x 120	40	1.8	< 40	1510	DCP6K07119EP00_
		1370 "	116 x 132	40	1.8	< 40	1660	DCP6K07137EQ00_
1470 "	116 x 140	40	1.8	< 40	1760	DCP6K07147ER00_		
900 VDC	760 VDC	190 μ F	85 x 60	30	1.9	< 40	380	DCP6N06190EB00_
		270 "	85 x 76	30	1.9	< 40	480	DCP6N06270EC00_
		315 "	85 x 85	30	1.8	< 40	540	DCP6N06315ED00_
		360 "	85 x 95	30	1.7	< 40	600	DCP6N06360EE00_
		450 "	85 x 110	30	1.7	< 40	690	DCP6N06450EF00_
		480 "	85 x 120	35	1.8	< 40	700	DCP6N06480E000_
		550 "	85 x 132	35	1.8	< 40	850	DCP6N06550E100_
		620 "	85 x 140	35	1.8	< 40	880	DCP6N06620EG00_
		730 "	116 x 95	40	1.7	< 40	1200	DCP6N06730EN00_
		900 "	116 x 110	40	1.7	< 40	1390	DCP6N06900EO00_
		980 "	116 x 120	40	1.8	< 40	1510	DCP6N06980EP00_
		1130 "	116 x 132	40	1.8	< 40	1660	DCP6N07113EQ00_
1200 "	116 x 140	40	1.8	< 40	1760	DCP6N07120ER00_		
1100 VDC	920 VDC	120 μ F	85 x 60	30	2.0	< 40	380	DCP6P06120EB00_
		170 "	85 x 76	30	2.0	< 40	480	DCP6P06170EC00_
		200 "	85 x 85	30	1.9	< 40	540	DCP6P06200ED00_
		230 "	85 x 95	30	1.9	< 40	600	DCP6P06230EE00_
		290 "	85 x 110	30	1.8	< 40	690	DCP6P06290EF00_
		325 "	85 x 120	40	1.8	< 40	700	DCP6P06325E000_
		360 "	85 x 132	40	1.8	< 40	850	DCP6P06360E100_
		390 "	85 x 140	40	2.0	< 40	880	DCP6P06390EG00_
		470 "	116 x 95	40	1.8	< 40	1200	DCP6P06470EN00_
		580 "	116 x 110	40	1.8	< 40	1390	DCP6P06580EO00_
		630 "	116 x 120	40	1.7	< 40	1510	DCP6P06630EP00_
		720 "	116 x 132	40	1.7	< 40	1660	DCP6P06720EQ00_
780 "	116 x 140	40	1.6	< 40	1760	DCP6P06780ER00_		

Contacts can handle: peak currents \hat{I} up to 5 kA
surge currents I_S up to 20 kA

Customer-specific capacitances or voltages on request

* General guide

Part number completion:	
Tolerance:	20 % = M 10 % = K 5 % = J
Packing:	bulk = S
Connection:	male = OM female = OF

Rights reserved to amend design data without prior notification.

Continuation

General Data

U_R		C_N	D x L mm	I_{rms} (max.)* at 70°C A	ESR (1 kHz)* mΩ	L_e nH	Approx. weight g	Part number
70°C	85°C							
1300 VDC	1100 VDC	85 μF	85 x 60	30	2.1	< 40	380	DCP6R25850EB00_
		120 "	85 x 76	30	2.1	< 40	480	DCP6R26120EC00_
		135 "	85 x 85	30	1.9	< 40	540	DCP6R26135ED00_
		160 "	85 x 95	30	1.9	< 40	600	DCP6R26160EE00_
		200 "	85 x 110	30	1.8	< 40	690	DCP6R26200EF00_
		215 "	85 x 120	30	1.8	< 40	700	DCP6R26215EO00_
		250 "	85 x 132	40	2.2	< 40	850	DCP6R26250E100_
		270 "	85 x 140	40	2.2	< 40	880	DCP6R26270EG00_
		320 "	116 x 95	40	1.8	< 40	1200	DCP6R26320EN00_
		390 "	116 x 110	40	1.8	< 40	1390	DCP6R26390EO00_
		430 "	116 x 120	40	1.7	< 40	1510	DCP6R26430EP00_
		490 "	116 x 132	40	1.7	< 40	1660	DCP6R26490EQ00_
		530 "	116 x 140	40	1.6	< 40	1760	DCP6R26530ER00_
		1500 VDC	1250 VDC	75 μF	85 x 60	25	2.5	< 40
110 "	85 x 76			25	2.5	< 40	480	DCP6S06110EC00_
120 "	85 x 85			25	2.3	< 40	540	DCP6S06120ED00_
145 "	85 x 95			30	2.3	< 40	600	DCP6S06145EE00_
180 "	85 x 110			30	2.3	< 40	690	DCP6S06180EF00_
195 "	85 x 120			40	2.4	< 40	700	DCP6S06195EO00_
225 "	85 x 132			40	2.4	< 40	850	DCP6S06225E100_
240 "	85 x 140			40	2.5	< 40	880	DCP6S06240EG00_
290 "	116 x 95			40	1.8	< 40	1200	DCP6S06290EN00_
355 "	116 x 110			40	1.8	< 40	1390	DCP6S06355EO00_
390 "	116 x 120			40	1.7	< 40	1510	DCP6S06390EP00_
445 "	116 x 132			40	1.7	< 40	1660	DCP6S06445EQ00_
480 "	116 x 140			40	1.7	< 40	1760	DCP6S06480ER00_

Contacts can handle: peak currents \hat{I} up to 5 kA
surge currents I_S up to 20 kA

Customer-specific capacitances or voltages on request

* General guide

female

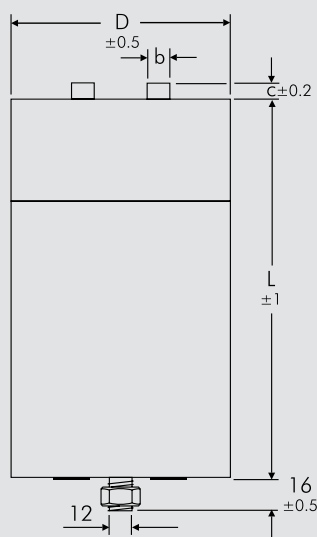

male

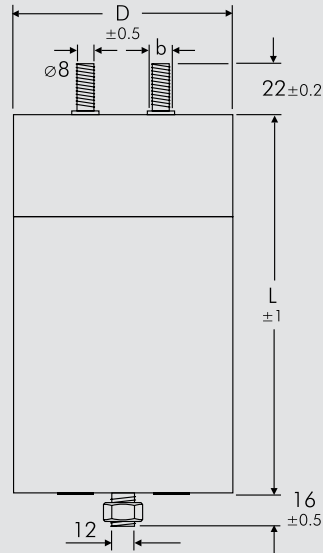

Part number completion:

Tolerance: 20 % = M
10 % = K
5 % = J
Packing: bulk = S
Connection: male = 0M
female = 0F

D	L	a	b	c
85	60	32	12	6
85	76	32	12	6
85	85	32	12	6
85	95	32	12	6
85	110	32	12	6
85	120	32	12	6
85	132	32	12	6
85	140	32	12	6
116	95	50	14	5
116	110	50	14	5
116	120	50	14	5
116	132	50	14	5
116	140	50	14	5

Dims. in mm.

Rights reserved to amend design data without prior notification.

Continuation: Versions with increased dimensioning for higher current carrying capability

General Data

U_R		C_N	D x L mm	I_{rms} (max.)* at 70°C A	ESR (1 kHz)* mΩ	L_e nH	Approx. weight g	Part number
70° C	85° C							
600 VDC	450 VDC	640 μF	85 x 110	50	1.3	< 40	690	DCHPI06640EF00_
		920 "	85 x 140	50	1.3	< 40	880	DCHPI06920EG00_
		1040 "	85 x 155	60	1.3	< 40	980	DCHPI07104EI00_
		1240 "	85 x 185	60	1.3	< 60	1165	DCHPI07124EI00_
		1520 "	85 x 210	60	1.2	< 60	1400	DCHPI07152E200_
		1660 "	85 x 235	60	1.2	< 60	1480	DCHPI07166EJ00_
		1900 "	85 x 252	60	1.2	< 60	1590	DCHPI07190EK00_
		2060 "	85 x 260	60	1.2	< 60	1640	DCHPI07206EL00_
		2490 "	85 x 345	70	1.0	< 70	2190	DCHPI07249EM00_
		1260 "	116 x 110	80	1.2	< 40	1385	DCHPI07126EO00_
		1820 "	116 x 140	80	1.2	< 40	1765	DCHPI07182ER00_
		2060 "	116 x 158	80	1.1	< 40	1990	DCHPI07206ES00_
		2440 "	116 x 185	80	1.1	< 60	2330	DCHPI07244ET00_
		3000 "	116 x 215	80	1.0	< 60	2710	DCHPI07300EU00_
		3280 "	116 x 230	90	1.0	< 60	2900	DCHPI07328E700_
		3780 "	116 x 255	90	1.0	< 60	3210	DCHPI07378EV00_
		4060 "	116 x 295	90	1.0	< 70	3720	DCHPI07406EW00_
		4920 "	116 x 342	100	0.7	< 70	4350	DCHPI07492EX00_
		700 VDC	600 VDC	460 μF	85 x 110	50	1.3	< 40
660 "	85 x 140			50	1.3	< 40	880	DCHPK06660EG00_
760 "	85 x 155			60	1.2	< 40	980	DCHPK06760EH00_
900 "	85 x 185			60	1.2	< 60	1165	DCHPK06900EI00_
1100 "	85 x 210			60	1.2	< 60	1400	DCHPK07110E200_
1200 "	85 x 235			60	1.2	< 60	1480	DCHPK07120EJ00_
1380 "	85 x 252			70	1.1	< 60	1590	DCHPK07138EK00_
1480 "	85 x 260			70	1.1	< 60	1640	DCHPK07148EL00_
1800 "	85 x 345			80	1.0	< 70	2190	DCHPK07180EM00_
920 "	116 x 110			80	1.3	< 40	1385	DCHPK06920EO00_
1320 "	116 x 140			80	1.3	< 40	1765	DCHPK07132ER00_
1500 "	116 x 158			80	1.3	< 40	1990	DCHPK07150ES00_
1780 "	116 x 185			80	1.2	< 60	2330	DCHPK07178ET00_
2180 "	116 x 215			90	1.2	< 60	2710	DCHPK07218EU00_
2380 "	116 x 230			90	1.0	< 60	2900	DCHPK07238E700_
2740 "	116 x 255			90	1.0	< 60	3210	DCHPK07274EV00_
2940 "	116 x 295			90	1.0	< 70	3720	DCHPK07294EW00_
3570 "	116 x 342			110	0.7	< 70	4350	DCHPK07357EX00_
900 VDC	760 VDC			380 μF	85 x 110	50	1.4	< 40
		540 "	85 x 140	50	1.4	< 40	880	DCHPN06540EG00_
		630 "	85 x 155	60	1.3	< 40	980	DCHPN06630EH00_
		720 "	85 x 185	60	1.3	< 60	1165	DCHPN06720EI00_
		900 "	85 x 210	60	1.1	< 60	1400	DCHPN06900E200_
		1000 "	85 x 235	70	1.0	< 60	1480	DCHPN07100EJ00_
		1140 "	85 x 252	70	0.9	< 60	1590	DCHPN07114EK00_
		1240 "	85 x 260	70	0.9	< 60	1640	DCHPN07124EL00_
		1500 "	85 x 345	80	0.7	< 70	2190	DCHPN07150EM00_

Contacts can handle: peak currents \hat{I} up to 10 kA
surge currents I_s up to 40 kA

Customer-specific capacitances or voltages on request

* General guide

Part number completion:	
Tolerance:	20 % = M
	10 % = K
	5 % = J
Packing:	bulk = S
Connection:	male = OM
	female = OF

Rights reserved to amend design data without prior notification.

Continuation page 135

Continuation

General Data

U_R		C_N	D x L mm	I_{rms} (max.)* at 70°C A	ESR (1 kHz)* mΩ	L_e nH	Approx. weight g	Part number
70°C	85°C							
900 VDC	760 VDC	760 μF	116 x 110	80	1.3	< 40	1385	DCHPN06760EO00
		1100 "	116 x 140	80	1.3	< 40	1765	DCHPN07110ER00
		1240 "	116 x 158	80	1.3	< 40	1990	DCHPN07124ES00
		1460 "	116 x 185	80	1.2	< 60	2330	DCHPN07146ET00
		1800 "	116 x 215	90	1.2	< 60	2710	DCHPN07180EU00
		1960 "	116 x 230	90	1.0	< 60	2900	DCHPN07196E700
		2260 "	116 x 255	90	1.0	< 60	3210	DCHPN07226EV00
		2400 "	116 x 295	90	1.0	< 70	3720	DCHPN07240EW00
		2940 "	116 x 342	110	0.7	< 70	4350	DCHPN07294EX00
		1100 VDC	920 VDC	240 μF	85 x 110	50	1.3	< 40
340 "	85 x 140			50	1.2	< 40	880	DCHPP06340EG00
400 "	85 x 155			50	1.2	< 40	980	DCHPP06400EH00
460 "	85 x 185			50	1.2	< 60	1165	DCHPP06460EI00
580 "	85 x 210			60	1.2	< 60	1400	DCHPP06580E200
640 "	85 x 235			60	1.1	< 60	1480	DCHPP06640EJ00
720 "	85 x 252			60	1.1	< 60	1590	DCHPP06720EK00
780 "	85 x 260			60	1.2	< 60	1640	DCHPP06780EL00
960 "	85 x 345			80	1.0	< 70	2190	DCHPP06960EM00
480 "	116 x 110			80	1.4	< 40	1385	DCHPP06480EO00
700 "	116 x 140			80	1.3	< 40	1765	DCHPP06700ER00
780 "	116 x 158			80	1.3	< 40	1990	DCHPP06780ES00
940 "	116 x 185			80	1.3	< 60	2330	DCHPP06940ET00
1160 "	116 x 215			90	1.2	< 60	2710	DCHPP07116EU00
1260 "	116 x 230			90	1.2	< 60	2900	DCHPP07126E700
1440 "	116 x 255			90	1.1	< 60	3210	DCHPP07144EV00
1560 "	116 x 295			90	1.0	< 70	3720	DCHPP07156EW00
1890 "	116 x 342	110	0.8	< 70	4350	DCHPP07189EX00		
1300 VDC	1100 VDC	170 μF	85 x 110	50	1.3	< 40	690	DCHPR26170EF00
		240 "	85 x 140	50	1.3	< 40	880	DCHPR26240EG00
		270 "	85 x 155	50	1.2	< 40	980	DCHPR26270EH00
		320 "	85 x 185	60	1.2	< 60	1165	DCHPR26320EI00
		400 "	85 x 210	60	1.2	< 60	1400	DCHPR26400E200
		440 "	85 x 235	60	1.1	< 60	1480	DCHPR26440EJ00
		500 "	85 x 252	60	1.1	< 60	1590	DCHPR26500EK00
		540 "	85 x 260	60	1.2	< 60	1640	DCHPR26540EL00
		660 "	85 x 345	80	1.0	< 70	2190	DCHPR26660EM00
		330 "	116 x 110	80	1.4	< 40	1385	DCHPR26330EO00
		480 "	116 x 140	80	1.4	< 40	1765	DCHPR26480ER00
		540 "	116 x 158	80	1.3	< 40	1990	DCHPR26540ES00
		640 "	116 x 185	80	1.3	< 60	2330	DCHPR26640ET00
		780 "	116 x 215	90	1.2	< 60	2710	DCHPR26780EU00
		860 "	116 x 230	90	1.2	< 60	2900	DCHPR26860E700
		980 "	116 x 255	90	1.1	< 60	3210	DCHPR26980EV00
		1060 "	116 x 295	90	1.1	< 70	3720	DCHPR27106EW00
1290 "	116 x 342	110	0.8	< 70	4350	DCHPR27129EX00		

Contacts can handle: peak currents \hat{I} up to 10 kA
surge currents I_S up to 40 kA

Customer-specific capacitances or voltages on request

* General guide

Part number completion:

Tolerance: 20 % = M
10 % = K
5 % = J
Packing: bulk = S
Connection: male = OM
female = OF

Rights reserved to amend design data without prior notification.

Continuation page 136

Continuation

General Data

U_R		C_N	D x L mm	I_{rms} (max.)* at 70°C A	ESR (1 kHz)* mΩ	L_e nH	Approx. weight g	Part number
70°C	85°C							
1500 VDC	1250 VDC	150 μF	85 x 110	50	1.3	< 40	690	DCHPS06150EF00_
		220 "	85 x 140	50	1.3	< 40	880	DCHPS06220EG00_
		240 "	85 x 155	50	1.2	< 40	980	DCHPS06240EH00_
		290 "	85 x 185	60	1.2	< 60	1165	DCHPS06290EI00_
		360 "	85 x 210	60	1.2	< 60	1400	DCHPS06360E200_
		390 "	85 x 235	60	1.1	< 60	1480	DCHPS06390EJ00_
		450 "	85 x 252	60	1.1	< 60	1590	DCHPS06450EK00_
		480 "	85 x 260	60	1.1	< 60	1640	DCHPS06480EL00_
		585 "	85 x 345	80	1.0	< 70	2190	DCHPS06585EM00_
		300 "	116 x 110	80	1.5	< 40	1385	DCHPS06300EO00_
		430 "	116 x 140	80	1.4	< 40	1765	DCHPS06430ER00_
		490 "	116 x 158	80	1.4	< 40	1990	DCHPS06490ES00_
		580 "	116 x 185	80	1.4	< 60	2330	DCHPS06580ET00_
		710 "	116 x 215	90	1.3	< 60	2710	DCHPS06710EU00_
		780 "	116 x 230	90	1.2	< 60	2900	DCHPS06780E700_
		890 "	116 x 255	90	1.2	< 60	3210	DCHPS06890EV00_
		960 "	116 x 295	90	1.1	< 70	3720	DCHPS06960EV00_
		1170 "	116 x 342	110	0.8	< 70	4350	DCHPS07117EX00_

Contacts can handle: peak currents \hat{I} up to 10 kA
surge currents I_S up to 40 kA

Customer-specific capacitances or voltages on request

* General guide

female

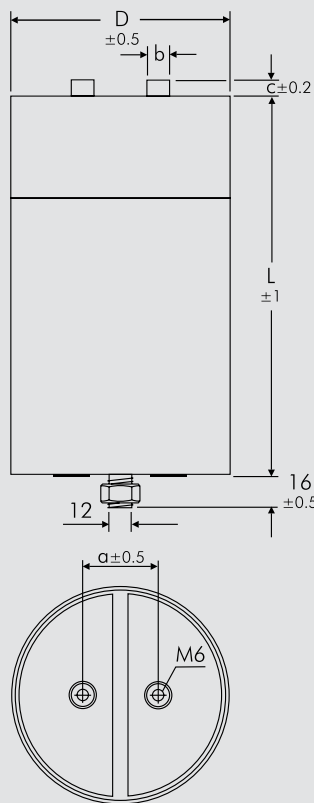

male

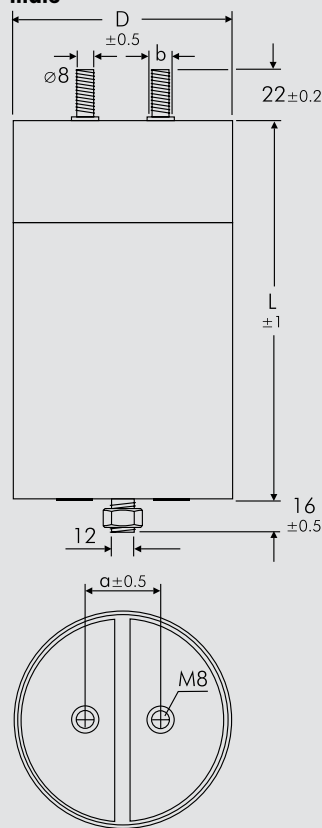

Part number completion:

Tolerance: 20 % = M
10 % = K
5 % = J
Packing: bulk = S
Connection: male = OM
female = OF

D	L	a	b	c
85	110	32	12	6
85	140	32	12	6
85	155	32	12	6
85	185	32	12	6
85	210	32	12	6
85	235	32	12	6
85	252	32	12	6
85	260	32	12	6
85	345	32	12	6
116	110	50	14	5
116	140	50	14	5
116	158	50	14	5
116	185	50	14	5
116	215	50	14	5
116	230	50	14	5
116	255	50	14	5
116	295	50	14	5
116	342	50	14	5

Dims. in mm.

Rights reserved to amend design data without prior notification.

Metallized Polypropylene (PP) - Capacitors for DC-Link Applications.
Capacitances from 140 μF to 8250 μF . Rated Voltages from 450 VDC to 1500 VDC.

Special Features

- Very high volume/capacitance ratio
- Self-healing, internal safety disconnect
- Safe contact configurations by screwable plates
- Dry construction without electrolyte or oil
- Very low dissipation factor
- Negative capacitance change versus temperature
- Very low dielectric absorption
- According to RoHS 2011/65/EU
- Customer-specific tabs, capacitances or voltages on request
- 105° C version on request

Typical Applications

As intermediate circuit capacitor e. g. in high power converter technology

Construction

Dielectric:

Polypropylene (PP) film

Capacitor electrodes:

Vacuum-deposited

Internal construction:

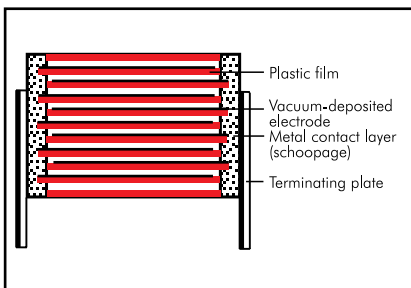

Encapsulation:

Solvent resistant, flame-retardant plastic case with PU seal

Terminations:

Tinned plates, customized plate configurations are possible.

Marking:

Colour: Black. Marking: Gold.

Electrical Data

Capacitance range: 140 μF to 8250 μF

Rated voltages:

450 VDC, 900 VDC, 1500 VDC

Capacitance tolerance: $\pm 10\%$

Operating temperature:

-55°C to $+85^\circ\text{C}$ ($+105^\circ\text{C}$ on request)

Insulation resistance at $+20^\circ\text{C}$:

$\geq 30\,000$ sec ($\text{M}\Omega \times \mu\text{F}$)

(mean value: 100 000 sec)

Measuring voltage: 100 V/1 min.

Self-inductance: ≤ 50 nH depending on tab configuration

ESR at $+20^\circ\text{C}$: See General Data.

Test voltage: 1.5 U_r , 10 sec

Dielectric absorption: 0.05 %

Voltage derating:

A derating factor of 1.35% per K must be applied from $+70^\circ\text{C}$ for AC currents (I_{rms})

Reliability:

Operational life $> 100\,000$ hours at 70°C hot spot

Failure rate < 50 fit (hot spot $\leq 70^\circ\text{C}$)

Specific dissipation:

See General Data.

Standards: in accordance with IEC 61071

Mounting Recommendation

Excessive mechanical strain, e.g. pressure or shock onto the capacitor body, is to be avoided during mounting and usage of the capacitors. When fixing the capacitor the screw torque is to be limited to max. 5 Nm.

Packing

Transportation-safe packing in cardboard boxes.

For further details and graphs please refer to Technical Information.

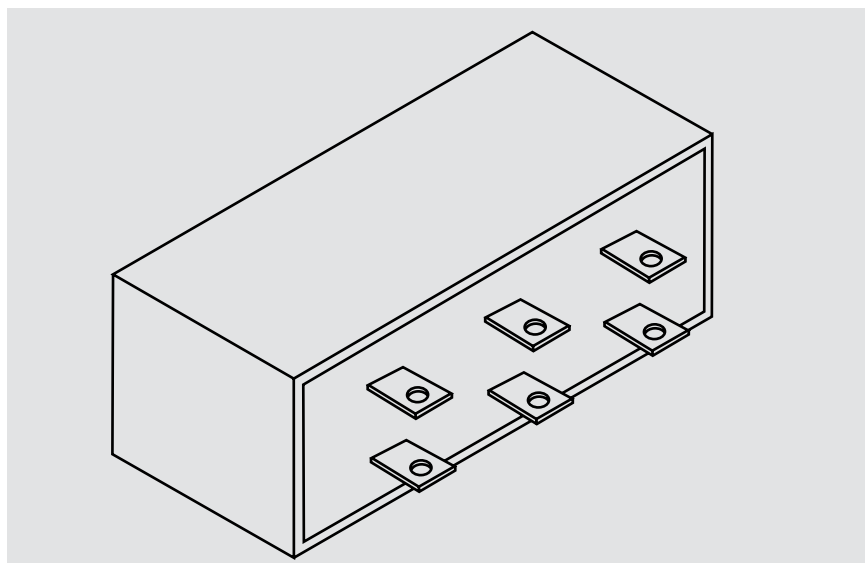

Continuation

General Data

U_R	C_N	E_N W_S	Size (mm)			I_{rms} (max.)* A	\hat{I}^* kA	I_S^* kA	ESR (1 kHz)* m Ω	R_{th}^* K/W	Approx. weight g	Part number
			W	H	L							
450 VDC	1440 μ F	146	84	66	179	100	4.6	18.6	0.3	2.8	1220	DCHCH07144JB00KS00
	2400 "	243	84	66	291	170	7.7	30.9	0.2	1.8	1985	DCHCH07240JH00KS00
	3000 "	304	107	91	179	120	6.7	26.7	0.3	2.0	2145	DCHCH07300JC00KS00
	4950 "	501	130	114	179	140	8.7	34.9	0.3	1.5	3265	DCHCH07495JE00KS00
	5000 "	506	107	91	291	190	11.1	44.5	0.2	1.3	3485	DCHCH07500JI00KS00
	8250 "	835	130	114	291	210	14.5	58.1	0.2	1.1	5305	DCHCH07825JJ00KS00
900 VDC	450 μ F	182	84	66	179	90	2.2	8.8	0.5	2.8	1220	DHCN06450JB00KS00
	750 "	304	84	66	291	140	3.7	14.6	0.3	1.8	1985	DHCN06750JH00KS00
	940 "	381	107	91	179	100	2.9	11.6	0.5	2.0	2145	DHCN06940JC00KS00
	1500 "	608	130	114	179	110	3.5	14.1	0.5	1.5	3265	DHCN07150JE00KS00
	1560 "	632	107	91	291	160	4.8	19.3	0.3	1.3	3485	DHCN07156JI00KS00
	2600 "	1053	130	114	291	180	6.1	24.4	0.3	1.1	5305	DHCN07260JJ00KS00
1500 VDC	140 μ F	158	84	66	179	60	1.2	4.9	0.9	2.8	1220	DHCS06140JB00KS00
	230 "	259	84	66	291	100	2.0	8.1	0.6	1.8	1985	DHCS06230JH00KS00
	280 "	315	107	91	179	80	1.5	6.1	0.8	2.0	2145	DHCS06280JC00KS00
	460 "	518	130	114	179	90	1.8	7.3	0.8	1.5	3265	DHCS06460JE00KS00
	470 "	529	107	91	291	130	2.5	10.2	0.5	1.3	3485	DHCS06470JI00KS00
	790 "	889	130	114	291	150	3.1	12.5	0.4	1.1	5305	DHCS06790JJ00KS00

* General guide

Customer-specific tabs, capacitances or voltages on request

External wiring:

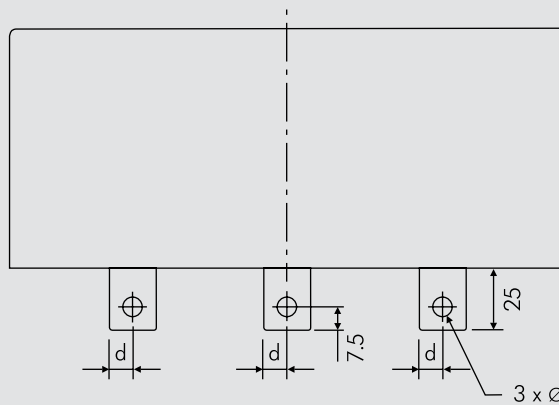
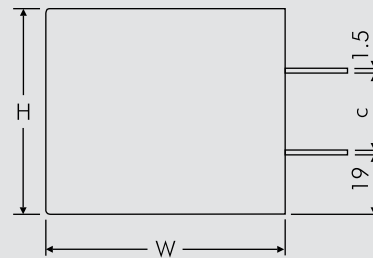
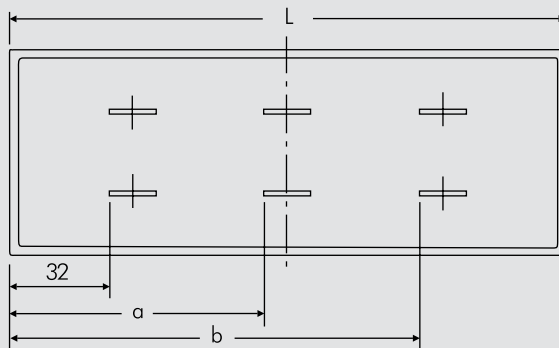
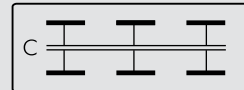

W	H	L	a	b	c	d
84	66	179	82	132	25	7.5
107	91	179	82	132	50	7.5
130	114	179	82	132	73	7.5
84	66	291	135.5	239	25	10
107	91	291	135.5	239	50	10
130	114	291	135.5	239	73	10

Dims. in mm. Case tolerances: general tolerances in accordance with ISO 2768-1 C (approximate)

Rights reserved to amend design data without prior notification.

Metallized Polypropylene (PP) - Capacitors for Hybrid Drives. Capacitance 500 µF. Rated Voltage 450 VDC.

Special Features

- Very high volume/capacitance ratio
- Self-healing, internal safety disconnecter
- Safe contact configuration by screwable plates
- Dry construction without electrolyte or oil
- Very low dissipation factor
- Negative capacitance change versus temperature
- Very low dielectric absorption
- According to RoHS 2011/65/EU
- Customer-specific capacitances or voltages on request

Typical Applications

As intermediate circuit capacitor e.g. in hybrid drives

Construction

Dielectric:

Polypropylene (PP) film

Capacitor electrodes:

Vacuum-deposited

Internal construction:

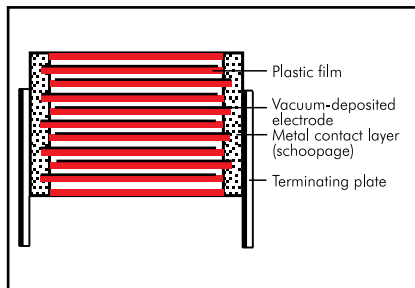

Encapsulation:

Solvent-resistant, flame-retardant plastic case with PU seal, UL 94 V-0

Terminations:

Tinned plates

Marking:

Colour: Black. Marking: Gold.

Electrical Data

Capacitance range:

500 µF

Rated voltage:

450 VDC

Capacitance tolerances:

±20%, ±10%, (±5% available subject to special enquiry)

Operating temperature range:

-55° C to +85° C (hot spot ≤ +110° C in combination with a heatsink)

Insulation resistance at +20° C:

≥ 10 000 sec (MΩ × µF)

(mean value: 50 000 s)

Measuring voltage: 100 V/1 min.

Dielectric loss factor $\tan \delta_0$: 2×10^{-4}

Test voltage: $1.3 U_r$, 2sec

Dielectric absorption: 0.05 %

Voltage derating:

A voltage derating factor of 1.35 % per K must be applied from +85° C for DC voltage.

Reliability:

Operational life > 100 000 hours at 40° C

Failure rate < 36 fit ($0.75 \times U_r$ and 40° C)

Mounting Recommendation

Excessive mechanical strain, e.g. pressure or shock onto the capacitor body, is to be avoided during mounting and usage of the capacitors. When fixing the capacitor the screw torque is to be limited to max. 5 Nm.

Packing

Transport-safe packing in cardboard boxes.

For further details and graphs please refer to Technical Information.

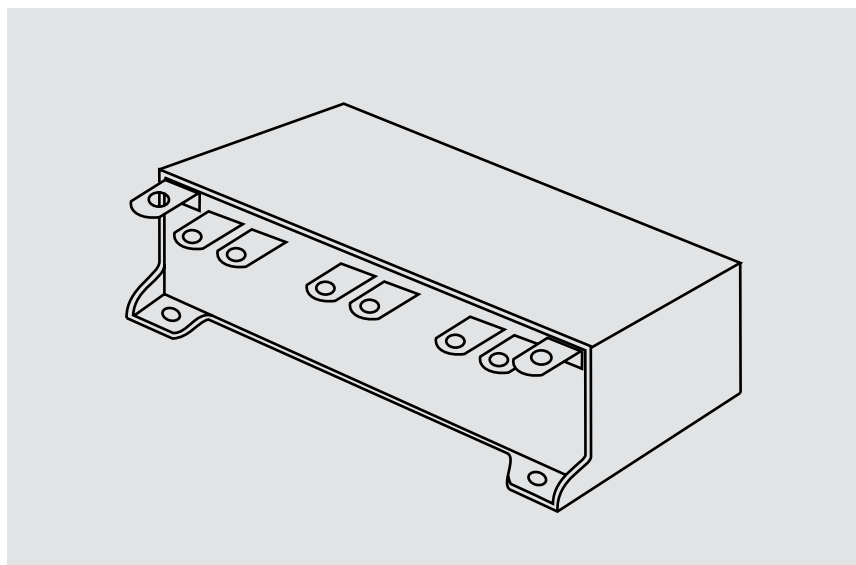

Continuation

General Data

Capacitance	U_R	I_{max} A	I_{rms}^* A	L_e nH	ESR* mΩ	Approx. weight g	Part number
500 μF	450 VDC	5000	120**	< 15	0.8**	1400	DCHYH06500JG00_-----

* $f = 1\text{ kHz}$

Customized solutions can be realized on request

** General guide

Part number completion:

Tolerance:	20 % = M
	10 % = K
	5 % = J
Packing:	bulk = S
Pin length:	none = 00

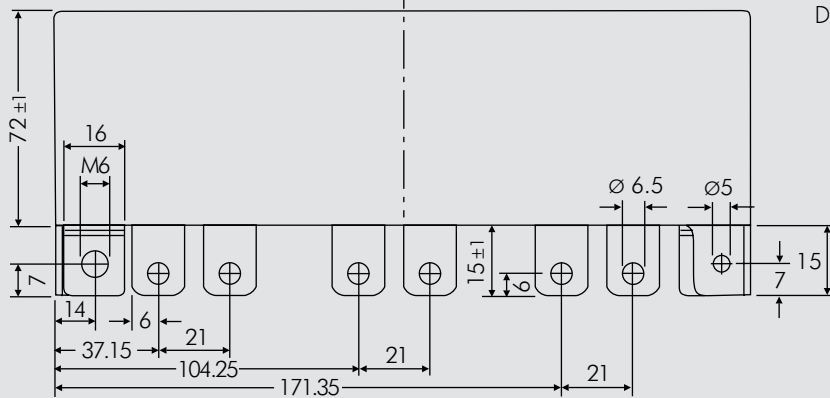
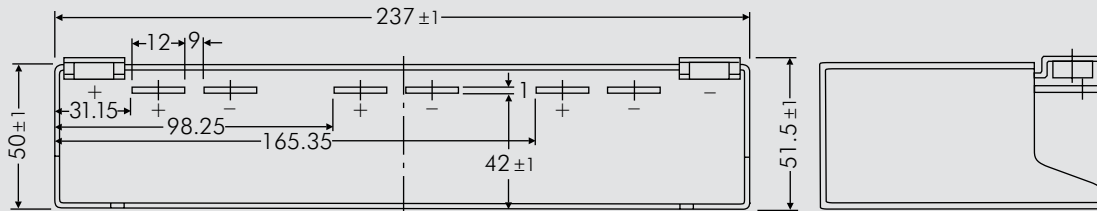

Dims. in mm.

Rights reserved to amend design data without prior notification.

Double-Layer Capacitor (SuperCap) Modules with Very High Capacitances

Special Features

- Modules with very high capacitance values from 62 F to 500 F and rated voltages from 16 VDC to 125 VDC
- Discharge current up to 1900 A
- Maintenance-free
- Series connected
- Actively balanced
- According to RoHS 2011/65/EU

Construction

Encapsulation: Metal case IP65

Terminal tread size: M8 / M10

Marking: Colour: Black. Marking: Gold

Internal construction:

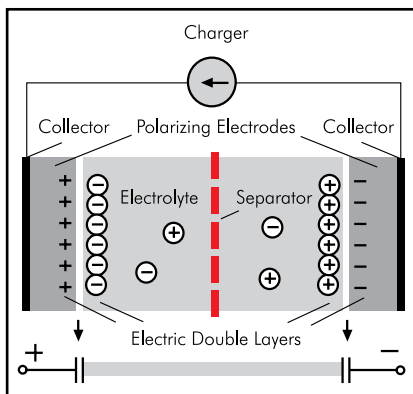

The WIMA PowerBlock range has a modular design. The configurations displayed are representative examples which at any time can be adapted in terms of capacitance, voltage or dimensions. Customized solutions can be realized on request.

Technical Options on Request

- Temperature monitoring
- Overvoltage signal
- Voltage monitoring
- Industrial connector/CAN-connector
- Application-adapted cooling
- Application-specific protection classes

General Data

U _R	C _N	Dimensions			Part number
		W	H	L	
16 V	105 F	157	69	250	MCPBA0B105MC00QV00
	500 F	157	156	250	MCPBA0B500MC00QV00
62.5 V	125 F	283	156	439	MCPBB4B125MC00QV00
125 V	62 F	409	156	575	MCPBDA620MC00QV00

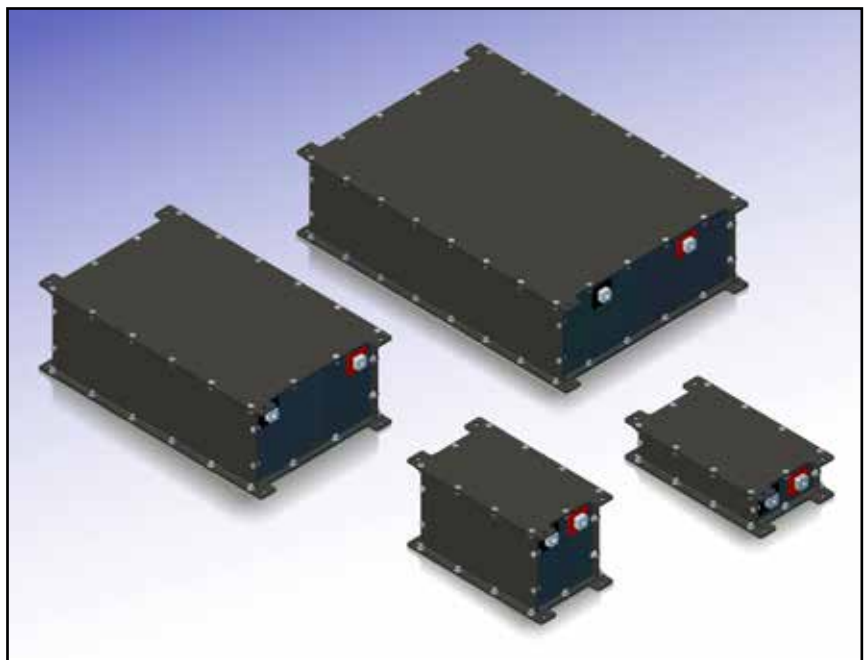

Application:

WIMA PowerBlock modules store energy and release it within short time in e.g.:

- Motor start in construction, agriculture and earth moving machines, trucks, busses, vessels, generators
- Railway technology e.g. locomotives, electric tramway, metro etc.
- Hybrid and heavy transportation in e.g. construction, agricultural and forest machines, city busses, forklifts, cranes etc.
- Automated guided vehicles (AGV) in production facilities, in-plant logistic systems etc.
- Uninterruptible power supply (UPS) in hospitals, telecommunication systems, oil and gas extraction etc.
- Wind power systems e.g. in pitch control.

Advantages:

- Fast supply of several 100 - 1000 A in direct current operation
- Operating temperature range from -40° C to +65° C
- Maintenance-free operation with up to 1 million charge/discharge cycles
- Life expectancy >10 years
- Low weight against batteries or secondary batteries
- Environmentally friendly materials
- No risk of damage do to complete discharge of the component
- Very fast recharge of the PowerBlock.

Conclusion:

The use of PowerBlocks as energy storage increases efficiency and life time of the applications, saves weight and cost for maintenance, and is environmentally friendly.

Continuation

Technical Data

Rated capacitance:	C _N [F]	105	500	125	62
Capacitance tolerance:	[%]	0%/+20%			
Rated voltage:	U _R [V]	16		62.5	125
Max. continuous current¹⁾:	I _C [A, rms]	54	130	130	130
Current, peak (1 sec):	I _P [A]	up to 680	up to 1900	up to 1900	up to 1900
Max. ESR, initial:	R _{bc} [mΩ]	5.2	2.1	8.3	16.4
Max. stored energy: ±20%	E _{max} [Wh]	3.7	17.8	67.8	134.5
Operating temperature:	T _{op} [°C]	-40° C ... +65° C			
Storage temperature:	T _{st} [°C]	-40° C ... +70° C			
Weight:	m [kg]	2.3	4.4	16	31.9
Volume:	V [l]	2.7	6.1	19.4	36.7

Additional Data

Case:	-	AlMg3
Lug terminals:	-	M8 / M10

Comparative Data

Lifetime:					
in hours ²⁾	[h]	90 000, rated voltage, 25° C			
in cycles ³⁾	cycles	>1 million, rated voltage, 25° C			
Energy density:					
gravimetric	E _d [Wh/kg]	1.62	4.03	4.24	4.21
volumetric	E _v [Wh/l]	1.38	2.9	3.5	3.67

M10 x 1.5 negative terminal
tread depth: 20 - 22 mm
max. torque 15 Nm

M8 x 1.25 positive terminal
tread depth: 20 - 22 mm
max. torque 15 Nm

Dims. in mm.

C _N	W ±1	H ±1	L ±1	W1 ±1	L1 ±1	a ±1	b ±1
62 F	409	156	575	376	555	97.1	189
105 F	157	69	250	695	230	47	63
125 F	283	156	439	250	419	46.6	189
500 F	157	156	250	124	230	47	63

1) ΔT = 40° C
 2) Requirements: ΔC < 20% decrease, ESR < 100% increase.
 3) Requirements: ΔC < 20% decrease, ESR < 100% increase.

Rights reserved to amend design data without prior notification.



A WIMA part number consists of 18 digits and is composed as follows:

- Field 1 - 4: Type description
- Field 5 - 6: Rated voltage
- Field 7 - 10: Capacitance
- Field 11 - 12: Size and PCM
- Field 13 - 14: Version code (e.g. Snubber versions)
- Field 15: Capacitance tolerance
- Field 16: Packing
- Field 17 - 18: Pin length (untaped)

1	2	3	4	5	6	7	8	9	10	11	12	13	14	15	16	17	18
M	K	S	2	C	0	2	1	0	0	1	A	0	0	M	S	S	D
MKS 2				63 VDC		0.01 µF			2.5x6.5x7.2			-		20%	bulk	6 -2	

<p>Type description:</p> <p>SMD-PET = SMDT SMD-PEN = SMDN SMD-PPS = SMDI FKP 02 = FKPO MKS 02 = MKS0 FKS 2 = FKS2 FKP 2 = FKP2 FKS 3 = FKS3 FKP 3 = FKP 3 MKS 2 = MKS2 MKP 2 = MKP2 MKS 4 = MKS4 MKP 4C = MKPC MKP 4 = MKP4 MKP 10 = MKP1 FKP 1 = FKP1 MKP-X2 = MKX2 MKP-X1 R = MKX1 MKP-Y2 = MKY2 MP 3-X2 = MPX2 MP 3-X1 = MPX1 MP 3-Y2 = MPY2 MP 3R-Y2 = MPRY MKP 4F = MKPF Snubber MKP = SNMP Snubber FKP = SNFP GTO MKP = GTOM DC-LINK MKP 3 = DCP3 DC-LINK MKP 4 = DCP4 DC-LINK MKP 4S = DCP5 DC-LINK MKP 5 = DCP5 DC-LINK MKP 6 = DCP6 DC-LINK HC = DCHC DC-LINK HY = DCHY</p>	<p>Rated voltage:</p> <p>50 VDC = B0 63 VDC = C0 100 VDC = D0 250 VDC = F0 400 VDC = G0 450 VDC = H0 520 VDC = H2 600 VDC = I0 630 VDC = J0 700 VDC = K0 800 VDC = L0 850 VDC = M0 900 VDC = N0 1000 VDC = O1 1100 VDC = P0 1200 VDC = Q0 1250 VDC = R0 1500 VDC = S0 1600 VDC = T0 2000 VDC = U0 2500 VDC = V0 3000 VDC = W0 4000 VDC = X0 6000 VDC = Y0 250 VAC = 0W 275 VAC = 1W 300 VAC = 2W 305 VAC = AW 350 VAC = BW 440 VAC = 4W 500 VAC = 5W ...</p>	<p>Capacitance:</p> <p>22 pF = 0022 47 pF = 0047 100 pF = 0100 150 pF = 0150 220 pF = 0220 330 pF = 0330 470 pF = 0470 680 pF = 0680 1000 pF = 1100 1500 pF = 1150 2200 pF = 1220 3300 pF = 1330 4700 pF = 1470 6800 pF = 1680 0.01 µF = 2100 0.022 µF = 2220 0.047 µF = 2470 0.1 µF = 3100 0.22 µF = 3220 0.47 µF = 3470 1 µF = 4100 2.2 µF = 4220 4.7 µF = 4470 10 µF = 5100 22 µF = 5220 47 µF = 5470 100 µF = 6100 220 µF = 6220 1000 µF = 7100 1500 µF = 7150 ...</p>	<p>Size:</p> <p>4.8x3.3x3 Size 1812 = KA 4.8x3.3x4 Size 1812 = KB 5.7x5.1x3.5 Size 2220 = QA 5.7x5.1x4.5 Size 2220 = QB 7.2x6.1x3 Size 2824 = TA 7.2x6.1x5 Size 2824 = TB 10.2x7.6x5 Size 4030 = VA 12.7x10.2x6 Size 5040 = XA 15.3x13.7x7 Size 6054 = YA 2.5x7x4.6 PCM 2.5 = 0B 3x7.5x4.6 PCM 2.5 = 0C 2.5x6.5x7.2 PCM 5 = 1A 3x7.5x7.2 PCM 5 = 1B 2.5x7x10 PCM 7.5 = 2A 3x8.5x10 PCM 7.5 = 2B 3x9x13 PCM 10 = 3A 4x9x13 PCM 10 = 3C 5x11x18 PCM 15 = 4B 6x12.5x18 PCM 15 = 4C 5x14x26.5 PCM 22.5 = 5A 6x15x26.5 PCM 22.5 = 5B 9x19x31.5 PCM 27.5 = 6A 11x21x31.5 PCM 27.5 = 6B 9x19x41.5 PCM 37.5 = 7A 11x22x41.5 PCM 37.5 = 7B 19x31x56 PCM 48.5 = 8D 25x45x57 PCM 52.5 = 9D ...</p> <p>Version code:</p> <p>Standard = 00 Version A1 = 1A Version A1.1.1 = 1B Version A2 = 2A ...</p>	<p>Tolerance:</p> <p>±20% = M ±10% = K ±5% = J ±2.5% = H ±1% = E ...</p> <p>Packing:</p> <p>AMMO H16.5 340x340 = A AMMO H16.5 490x370 = B AMMO H18.5 340x340 = C AMMO H18.5 490x370 = D REEL H16.5 360 = F REEL H16.5 500 = H REEL H18.5 360 = I REEL H18.5 500 = J ROLL H16.5 = N ROLL H18.5 = O BLISTER W12 180 = P BLISTER W12 330 = Q BLISTER W16 330 = R BLISTER W24 330 = T Bulk/TPS Standard = S ...</p> <p>Pin length (untaped)</p> <p>3.5 ±0.5 = C9 6 -2 = SD 16 ±1 = P1 ...</p> <p>Pin length (taped)</p> <p>none = 00</p>
--	--	---	--	---

The data on this page is not complete and serves only to explain the part number system. Part number information is listed on the pages of the respective WIMA range.



Blister Tape Packaging and Packing Units of the WIMA SMD Capacitors

Tape reel:

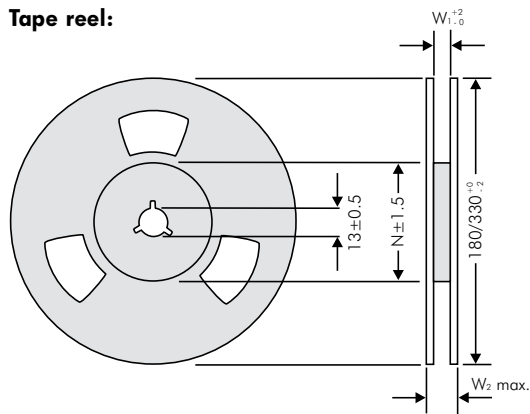

Tape advance and return:

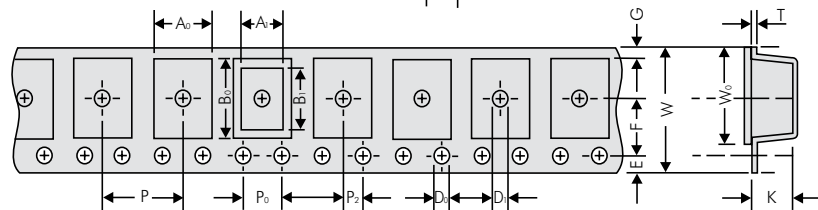
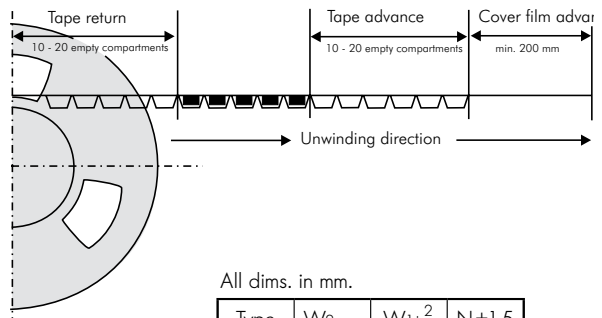

All dims. in mm.

Type	W _{2max}	W _{1±0.2}	N±1.5
1812	19	12.4	62
2220	19	12.4	62
2824	19	12.4	62
4030	22.4	16.4	60
5040	30.4	24.4	90
6054	30.4	24.4	90

Packing units

Size Code 1812		A ₀ ±0.1	A ₁	B ₀ ±0.1	B ₁	D ₀ +0.1 -0	D ₁ +0.1 -0	P ±0.1	P ₀ * ±0.1	P ₂ ±0.05	E ±0.1	F ±0.05	G	W ±0.3	W ₀ ±0.2	K ±0.1	T ±0.1
Box size	Code																
4.8x3.3x3	KA	3.55	3.3	5.1	4.8	∅1.5	∅1.5	8	4	2	1.75	5.5	2.2	12	9.5	3.4	0.3
4.8x3.3x4	KB	3.55	3.3	5.1	4.8	∅1.5	∅1.5	8	4	2	1.75	5.5	2.2	12	9.5	4.4	0.3

taped Reel 180 mm ø	taped Reel 330 mm ø	bulk Standard
700	2500	3000
500	2000	3000

Size Code 2220		A ₀ ±0.1	A ₁	B ₀ ±0.1	B ₁	D ₀ +0.1 -0	D ₁ +0.1 -0	P ±0.1	P ₀ * ±0.1	P ₂ ±0.05	E ±0.1	F ±0.05	G	W ±0.3	W ₀ ±0.2	K ±0.1	T ±0.1
Box size	Code																
5.7x5.1x3.5	QA	6.3	5.7	5.6	5.1	∅1.5	∅1.5	8	4	2	1.75	5.5	1.95	12	9.5	3.7	0.3
5.7x5.1x4.5	QB	6.3	5.7	5.6	5.1	∅1.5	∅1.5	8	4	2	1.75	5.5	1.95	12	9.5	4.7	0.3

taped Reel 180 mm ø	taped Reel 330 mm ø	bulk Standard
500	1800	3000
400	1500	3000

Size Code 2824		A ₀ ±0.1	A ₁	B ₀ ±0.1	B ₁	D ₀ +0.1 -0	D ₁ +0.1 -0	P ±0.1	P ₀ * ±0.1	P ₂ ±0.05	E ±0.1	F ±0.05	G	W ±0.3	W ₀ ±0.2	K ±0.1	T ±0.1
Box size	Code																
7.2x6.1x3	TA	6.6	6.1	7.7	7.2	∅1.5	∅1.5	12	4	2	1.75	5.5	0.9	12	9.5	3.4	0.3
7.2x6.1x5	TB	6.6	6.1	7.7	7.2	∅1.5	∅1.5	12	4	2	1.75	5.5	0.9	12	9.5	5.4	0.4

taped Reel 330 mm ø	bulk Standard
1500	2000
750	2000

Code	A ₀ ±0.1	A ₁	B ₀ ±0.1	B ₁	D ₀ +0.1 -0	D ₁ +0.1 -0	P ±0.1	P ₀ * ±0.1	P ₂ ±0.05	E ±0.1	F ±0.05	G	W ±0.3	W ₀ ±0.2	K ±0.1	T ±0.1	
Size Code 4030	VA	10.7	10.2	8.1	9.1	∅1.5	∅1.5	16	4	2	1.75	7.5	1.9	16	13.3	5.5	0.3
Size Code 5040	XA	13.5	12.7	11	11.5	∅1.5	∅1.5	16	4	2	1.75	11.5	4.7	24	21.3	6.5	0.3
Size Code 6054	YA	17.0	16.5	15.6	15.0	∅1.5	∅1.5	20	4	2	1.75	11.5	2.95	24	21.3	7.5	0.3

taped Reel 330 mm ø	bulk Standard
775	2000
600	1000
450	500

* cumulative after 10 steps ± 0.2 mm max.
Samples and pre-production needs on request or 1 Reel minimum.

Part number codes for SMD packing

W (Blister)	ø in mm	Code
12	180	P
12	330	Q
16	330	R
24	330	T

Bulk Standard	S
---------------	----------

Typical Dimensions for Taping Configuration

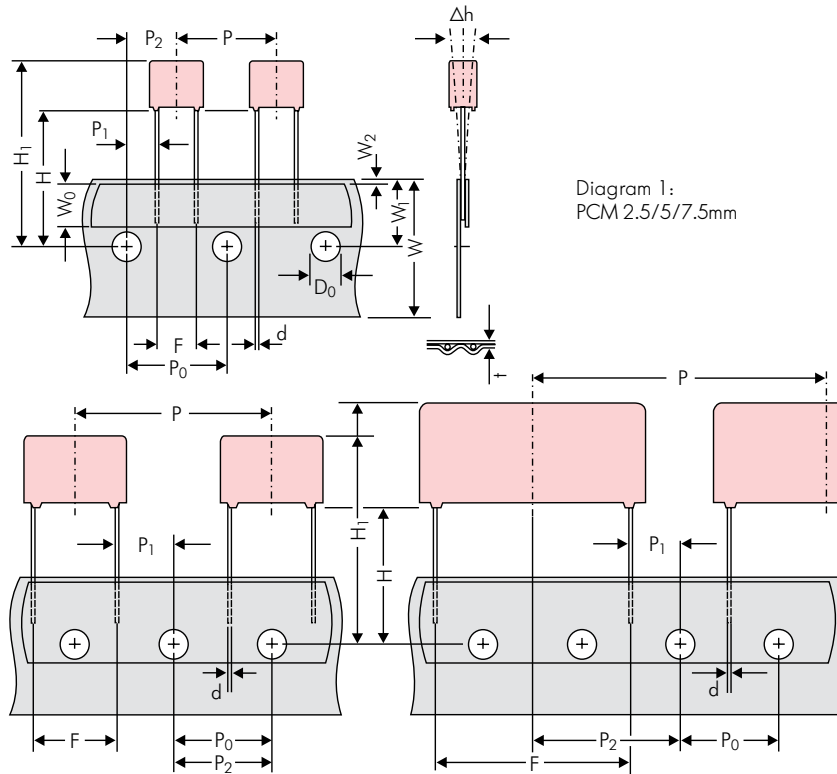

Diagram 1:
PCM 2.5/5/7.5mm

Diagram 2: PCM 10/15 mm

Diagram 3: PCM 22.5 and 27.5*mm

*PCM 27.5 taping possible with two feed holes between components

Designation	Symbol	Dimensions for Radial Taping						
		PCM 2.5 taping	PCM 5 taping	PCM 7.5 taping	PCM 10 taping*	PCM 15 taping*	PCM 22.5 taping	PCM 27.5 taping
Carrier tape width	W	18.0 ±0.5	18.0 ±0.5	18.0 ±0.5	18.0 ±0.5	18.0 ±0.5	18.0 ±0.5	18.0 ±0.5
Hold-down tape width	W ₀	6.0 for hot-sealing adhesive tape	6.0 for hot-sealing adhesive tape	12.0 for hot-sealing adhesive tape	12.0 for hot-sealing adhesive tape	12.0 for hot-sealing adhesive tape	12.0 for hot-sealing adhesive tape	12.0 for hot-sealing adhesive tape
Hole position	W ₁	9.0 ±0.5	9.0 ±0.5	9.0 ±0.5	9.0 ±0.5	9.0 ±0.5	9.0 ±0.5	9.0 ±0.5
Hold-down tape position	W ₂	0.5 to 3.0 max.	0.5 to 3.0 max.	0.5 to 3.0 max.	0.5 to 3.0 max.	0.5 to 3.0 max.	0.5 to 3.0 max.	0.5 to 3.0 max.
Feed hole diameter	D ₀	4.0 ±0.2	4.0 ±0.2	4.0 ±0.2	4.0 ±0.2	4.0 ±0.2	4.0 ±0.2	4.0 ±0.2
Pitch of component	P	12.7 ±1.0	12.7 ±1.0	12.7 ±1.0	25.4 ±1.0	25.4 ±1.0	38.1 ±1.5	38.1 ±1.5 or 50.8 ±1.5
Feed hole pitch	P ₀	12.7 ±0.3 cumulative pitch error max. 1.0 mm/20 pitch	12.7 ±0.3 cumulative pitch error max. 1.0 mm/20 pitch	12.7 ±0.3 cumulative pitch error max. 1.0 mm/20 pitch	12.7 ±0.3 cumulative pitch error max. 1.0 mm/20 pitch	12.7 ±0.3 cumulative pitch error max. 1.0 mm/20 pitch	12.7 ±0.3 cumulative pitch error max. 1.0 mm/20 pitch	12.7 ±0.3 cumulative pitch error max. 1.0 mm/20 pitch
Feed hole centre to pin	P ₁	5.1 ±0.5	3.85 ±0.7	2.6 ±0.7	7.7 ±0.7	5.2 ±0.7	7.8 ±0.7	5.3 ±0.7
Hole centre to component centre	P ₂	6.35 ±1.3	6.35 ±1.3	6.35 ±1.3	12.7 ±1.3	12.7 ±1.3	19.05 ±1.3	19.05 ±1.3
Feed hole centre to bottom edge of the component	H	16.5 ±0.3 18.5 ±0.5	16.5 ±0.3 18.5 ±0.5	16.5 ±0.5 18.5 ±0.5	16.5 ±0.5 18.5 ±0.5	16.5 ±0.5 18.5 ±0.5	16.5 ±0.5 18.5 ±0.5	16.5 ±0.5 18.5 ±0.5
Feed hole centre to top edge of the component	H ₁	H+H _{component} < H ₁ 32.25 max.	H+H _{component} < H ₁ 32.25 max.	H+H _{component} < H ₁ 24.5 to 31.5	H+H _{component} < H ₁ 25.0 to 31.5	H+H _{component} < H ₁ 26.0 to 37.0	H+H _{component} < H ₁ 30.0 to 43.0	H+H _{component} < H ₁ 35.0 to 45.0
Pin spacing at upper edge of carrier tape	F	2.5 ±0.5	5.0 ^{+0.8} _{-0.2}	7.5 ±0.8	10.0 ±0.8	15 ±0.8	22.5 ±0.8	27.5 ±0.8
Pin diameter	d	0.4 ±0.05	0.5 ±0.05	0.5 ±0.05 or 0.6 ^{+0.06} _{-0.05}	0.5 ±0.05 or 0.6 ^{+0.06} _{-0.05}	0.8 ^{+0.08} _{-0.05}	0.8 ^{+0.08} _{-0.05}	0.8 ^{+0.08} _{-0.05}
Component alignment	Δh	± 2.0 max.	± 2.0 max.	± 3.0 max.	± 3.0 max.	± 3.0 max.	± 3.0 max.	± 3.0 max.
Total tape thickness	t	0.7 ±0.2	0.7 ±0.2	0.7 ±0.2	0.7 ±0.2	0.7 ±0.2	0.7 ±0.2	0.7 ±0.2
Package (see also page 146)	ROLL/AMMO			AMMO				
	REEL	φ 360 max. φ 30 ±1	B 52 ±2 58 ±2 } depending on comp. dimensions	REEL	φ 360 max. φ 30 ±1	52 ±2 58 ±2 or 66 ±2	REEL	φ 500 max. φ 25 ±1
Unit	see details page 147.							

Dims in mm.

* Diameter of pins see General Data.

* PCM 10 and PCM 15 can be crimped to PCM 7.5.

Position of components according to PCM 7.5 (sketch 11). P₀ = 12.7 or 15.0 is possible

Please clarify customer-specific deviations with the manufacturer.

Types of Tape Packaging of Capacitors for Automatic Radial Insertion

■ ROLL Packaging

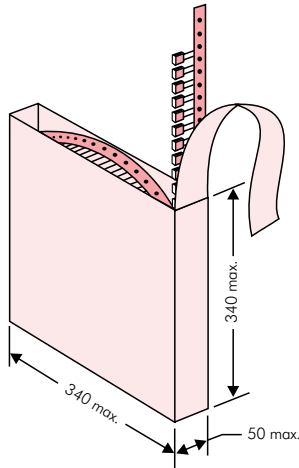

■ AMMO Packaging

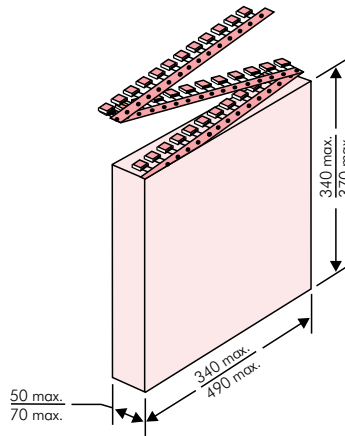

■ REEL Packaging

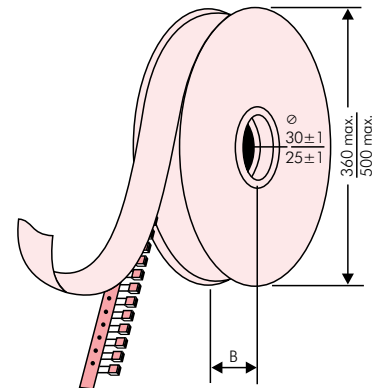

BAR CODE (Labelling)

Labelling of package units in plain text and with alphanumerical Bar Code

Scanner decoding of

- WIMA supplier number
- Customer's P/O number
- Customer's part number
- WIMA confirmation number
- WIMA part number
- Lot number
- Date code
- Quantity

In addition part description of

- article
- capacitance value
- rated voltage
- dimensions
- capacitance tolerance
- packing

as well as gross weight and customer's name are indicated in plain text.

WIMA Best Capacitors Made In Germany		Werk Unna
Supplier-ID: 123456789	RoHS 2011/65/EU	Date Code: 08.10.10
Purchase Order No. (P/O): Bestellung xyz		Quantity: 5.000
Customer Part No.: KUNDETEILENUMMER		Customer No.: 0000100002
		Gross Weight [g]: 1870
WIMA Confirmation No.: 0001004053000100	WIMA Part No.: MKS2C034701C00K8SD	
Handling Unit: MKS 2	QTY: 5.000	COO: DE
	MKS 2 0.47 µF 63 VDC 3.5x8.5x7.2 RM5	
1000067326	Standard 10% Loss - Standard	Dichte 6-2
Vorlage Debitor Inland		Week 03/2011

BARCODE „Code 39“

Packing Quantities for Capacitors with Radial Pins in PCM 2.5 mm to 22.5 mm



PCM	Size				bulk	pcs. per packing unit									
						ROLL		REEL				AMMO			
	W	H	L	Codes		S	H16.5	H18.5	ø 360	ø 500	340 x 340	490 x 370			
					N	O	F	I	H	J	A	C	B	D	
2.5 mm	2.5	7	4.6	0B	5000		2200	2500				2800			
	3	7.5	4.6	0C	5000		2000	2300				2300			
	3.8	8.5	4.6	0D	5000		1500	1800				1800			
	4.6	9	4.6	0E	5000		1200	1500				1500			
	5.5	10	4.6	0F	5000		900	1200				1200			
5 mm	2.5	6.5	7.2	1A	5000		2200	2500				2800			
	3	7.5	7.2	1B	5000		2000	2300				2300			
	3.5	8.5	7.2	1C	5000		1600	2000				2000			
	4.5	6	7.2	1D	6000		1300	1500				1500			
	4.5	9.5	7.2	1E	4000		1300	1500				1500			
	5	10	7.2	1F	3500		1100	1400				1400			
	5.5	7	7.2	1G	4000		1000	1200				1200			
	5.5	11.5	7.2	1H	2500		1000	1200				1200			
	6.5	8	7.2	1I	2500		800	1000				1000			
	7.2	8.5	7.2	1J	2500		700	1000				1000			
	7.2	13	7.2	1K	2000		700	950				1000			
	8.5	10	7.2	1L	2000		600	800				800			
8.5	14	7.2	1M	1500		600	800				800				
11	16	7.2	1N	1000		500	600				400				
7.5 mm	2.5	7	10	2A	5000			2500		4400		2500			
	3	8.5	10	2B	5000			2200		4300		2300		4150	
	4	9	10	2C	4000			1700		3200		1700		3100	
	4.5	9.5	10.3	2D	3500			1500		2900		1400		2700	
	5	10.5	10.3	2E	3000			1300		2500		1300			
	5.7	12.5	10.3	2F	2000			1000		2200		1100			
	7.2	12.5	10.3	2G	1500			900		1800		1000			
10 mm	3	9	13	3A	3000			1100		2200				1900	
	4	8.5	13.5	FA	3000			900		1600				1450	
	4	9	13	3C	3000			900		1600				1450	
	4	9.5	13	3D	3000			900		1600				1400	
	5	10	13.5	FB	2000			700		1300				1200	
	5	11	13	3F	3000			700		1300				1200	
	6	12	13	3G	2400			550		1100				1000	
	6	12.5	13	3H	2400			550		1100				1000	
8	12	13	3I	2000			400		800				740		
15 mm	5	11	18	4B	2400			600		1200				1150	
	5	13	19	FC	1000			600		1200				1200	
	6	12.5	18	4C	2000			500		1000				1000	
	6	14	19	FD	1000			500		1000				1000	
	7	14	18	4D	1600			450		900				850	
	7	15	19	FE	1000			450		900				850	
	8	15	18	4F	1200			400		800				740	
	8	17	19	FF	500			400		800				740	
	9	14	18	4H	1200			350		700				650	
	9	16	18	4J	900			350		700				650	
	10	18	19	FG	500			300		650				590	
11	14	18	4M	1000			300		600				540		
22.5 mm	5	14	26.5	5A	1200					800				770	
	6	15	26.5	5B	1000					700				640	
	7	16.5	26.5	5D	760					600				550	
	8	20	28	FH	500					500				480	
	8.5	18.5	26.5	5F	500					480				450	
	10	22	28	FI	570*					420				380	
	10.5	19	26.5	5G	594*					400				360	
	10.5	20.5	26.5	5H	594*					400				360	
	11	21	26.5	5I	561*					380				350	
	12	24	28	FJ	480*					350				310	

* TPS (Tray-Packing-System). Plate versions may have different packing units. Samples and pre-production needs on request.

■ Moulded versions.

Rights reserved to amend design data without prior notification.



Packing Quantities for Capacitors with Radial Pins in PCM 27.5 mm to 52.5 mm

PCM	Size				bulk	pcs. per packing unit											
						ROLL		REEL				AMMO					
	W	H	L	Codes		S	N	O	ø 360		ø 500		340 x 340		490 x 370		
								H16.5	H18.5	H16.5	H18.5	H16.5	H18.5	H16.5	H18.5	H16.5	H18.5
								F	I	H	J	A	C	B	D		
27.5 mm	9	19	31.5	6A	567*	-	-	-	-	460/340*	-	-	420				
	11	21	31.5	6B	459*	-	-	-	-	380/280*	-	-	350				
	13	24	31.5	6D	378*	-	-	-	-	300	-	-	290				
	13	25	33	FK	405*	-	-	-	-	-	-	-	-				
	15	26	31.5	6F	324*	-	-	-	-	270	-	-	250				
	15	26	33	FL	324*	-	-	-	-	-	-	-	-				
	17	29	31.5	6G	198*	-	-	-	-	-	-	-	-				
	17	34.5	31.5	6I	198*	-	-	-	-	-	-	-	-				
	20	32	33	FM	162*	-	-	-	-	-	-	-	-				
	20	39.5	31.5	6J	162*	-	-	-	-	-	-	-	-				
37.5 mm	9	19	41.5	7A	441*	-	-	-	-	-	-	-	-				
	11	22	41.5	7B	357*	-	-	-	-	-	-	-	-				
	13	24	41.5	7C	294*	-	-	-	-	-	-	-	-				
	15	26	41.5	7D	252*	-	-	-	-	-	-	-	-				
	17	29	41.5	7E	154*	-	-	-	-	-	-	-	-				
	19	32	41.5	7F	140*	-	-	-	-	-	-	-	-				
	20	39.5	41.5	7G	126*	-	-	-	-	-	-	-	-				
	24	45.5	41.5	7H	112*	-	-	-	-	-	-	-	-				
	31	46	41.5	7I	84*	-	-	-	-	-	-	-	-				
	35	50	41.5	7J	35*	-	-	-	-	-	-	-	-				
	40	55	41.5	7K	28*	-	-	-	-	-	-	-	-				
48.5 mm	19	31	56	8D	120*	-	-	-	-	-	-	-	-				
	23	34	56	8E	80*	-	-	-	-	-	-	-	-				
	27	37.5	56	8H	84*	-	-	-	-	-	-	-	-				
	33	48	56	8J	25*	-	-	-	-	-	-	-	-				
	37	54	56	8L	25*	-	-	-	-	-	-	-	-				
52.5 mm	25	45	57	9D	70*	-	-	-	-	-	-	-	-				
	30	45	57	9E	60*	-	-	-	-	-	-	-	-				
	35	50	57	9F	25*	-	-	-	-	-	-	-	-				
	45	55	57	9H	20*	-	-	-	-	-	-	-	-				
	45	65	57	9J	20*	-	-	-	-	-	-	-	-				

* for 2-inch transport pitches.

* TPS (Tray-Packing-System). Plate versions may have different packing units. Samples and pre-production needs on request.

■ Moulded versions. Rights reserved to amend design data without prior notification.

Updated data on www.wima.com



TAW ELECTRONICS, INC.
Burbank, CA 91505 USA

Masterdistributor since

1963

Phone: 800 339-2288

Fax: 818-846-1194

sales@tawelectronics.com
technical@tawelectronics.com
www.tawelectronics.com