

MATERIAL
 Insulator:LCP,UL94V-0
 Contact:Brass

ORDER INFORMATION

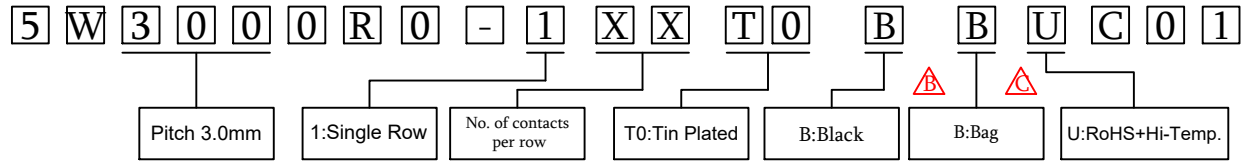

Circuits	Dim. A	Dim. B
2	3.0	9.65
3	6.0	12.65
4	9.0	15.65
5	12.0	18.65
6	15.0	21.65
7	18.0	24.65
8	21.0	27.65
9	24.0	30.65
10	27.0	33.65
11	30.0	36.65
12	33.0	39.65

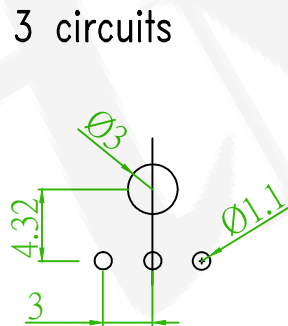
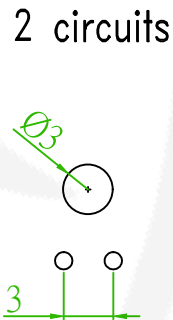
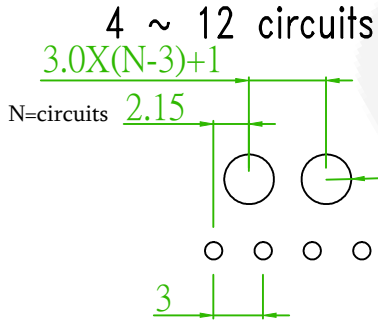
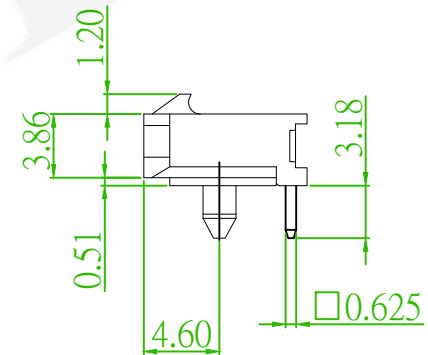
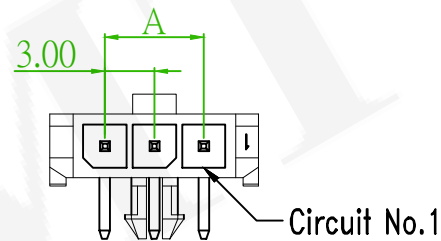
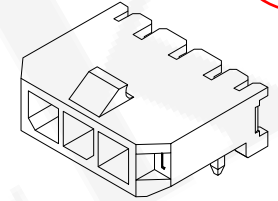
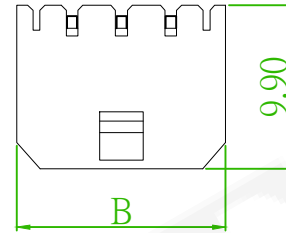

PCB LAYOUT
 TOLERANCE ±0.1

Old Part No.:3000R-1XXTB-L

糧德精密有限公司
 Amtek Technology Co., Ltd.
 TEL: 886-2-2260-6878
 FAX: 886-2-2260-8030

品名 TITLE	3.0mm WAFER				頁數 Page	1/2
品號 PART NO.	5W3000R0-1XXT0BBUC01			繪圖 DRAWN	Roy 2016/07/29	
圖號 DRAWING NO.	GW083-EL493	版本 REV.	F	核對 CHECKED	Boris 2016/07/29	
客戶品號 CUSTOMER P/N		比例 SCALE	None	承認 APPROVED	Boris 2016/07/29	
公差 TOLERANCE	.X ± 0.25 .XX ± 0.15	單位 UNIT	mm	THIRD ANGLE PROJECTION		

REV.	ECN NO. OR DESCRIPTION	REVISED	DATE
x1	ECN NO.221123: Revise the specification	Rex	2023/01/31
x1	Add the Page 2, 02-12P Drawing	Benson	2020/09/11
x2	Revise operation temperature and insulator	Andy	2017/09/06
x1	ECN/ECR No.170544,Revise the Part No.:5W3000R0-1XXT0BXUC01→5W3000R0-1XXT0BBUC01	Eloise	2017/06/09

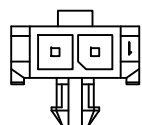

2P

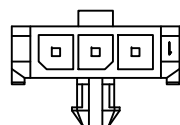

3P

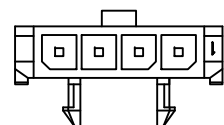

4P

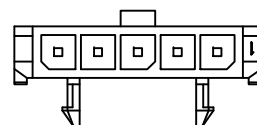

5P

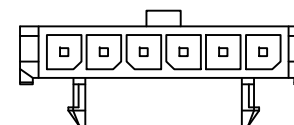

6P

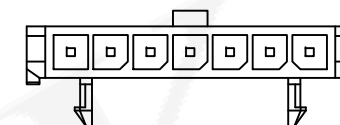

7P

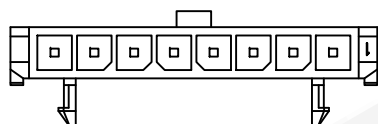

8P

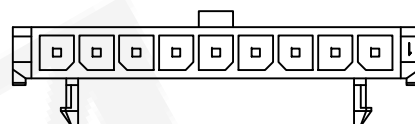

9P

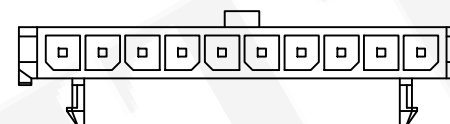

10P

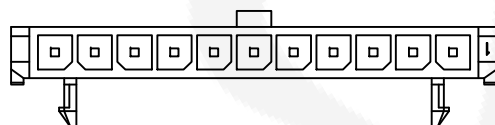

11P

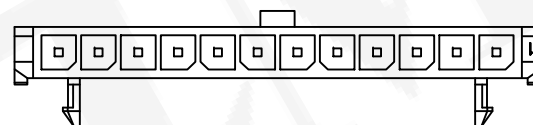

12P

Old Part No.:3000R-1XXTB-L

	ECN NO.221123: Revise the specification	Rex	2023/01/31
	Add the Page 2, 02-12P Drawing	Benson	2020/09/11
	Revise operation temperature and insulator	Andy	2017/09/06
	ECN/ECR No.170544,Revise the Part No.:5W3000R0-1XXT0BBUC01→5W3000R0-1XXT0BBUC01	Eloise	2017/06/09
REV.	ECN NO. OR DESCRIPTION	REVISED	DATE



糧德精密有限公司
Amtek Technology Co., Ltd.
TEL: 886-2-2260-6878
FAX: 886-2-2260-8030

品名 TITLE	3.0mm WAFER				頁數 Page	2/2
品號 PART NO.	5W3000R0-1XXT0BBUC01			繪圖 DRAWN	Roy 2016/07/29	
圖號 DRAWING NO.	GW083-EL493	版本 REV.	F	核對 CHECKED	Boris 2016/07/29	
客戶品號 CUSTOMER P/N		比例 SCALE	None	承認 APPROVED	Boris 2016/07/29	
公差 TOLERANCE	.X ± 0.25	單位 UNIT	mm	THIRD ANGLE PROJECTION		
	.XX ± 0.15					

5W3000R0-1XXT0BBUC01

3000 Series 3.0mm Wafer Right Angle Type 1 Row

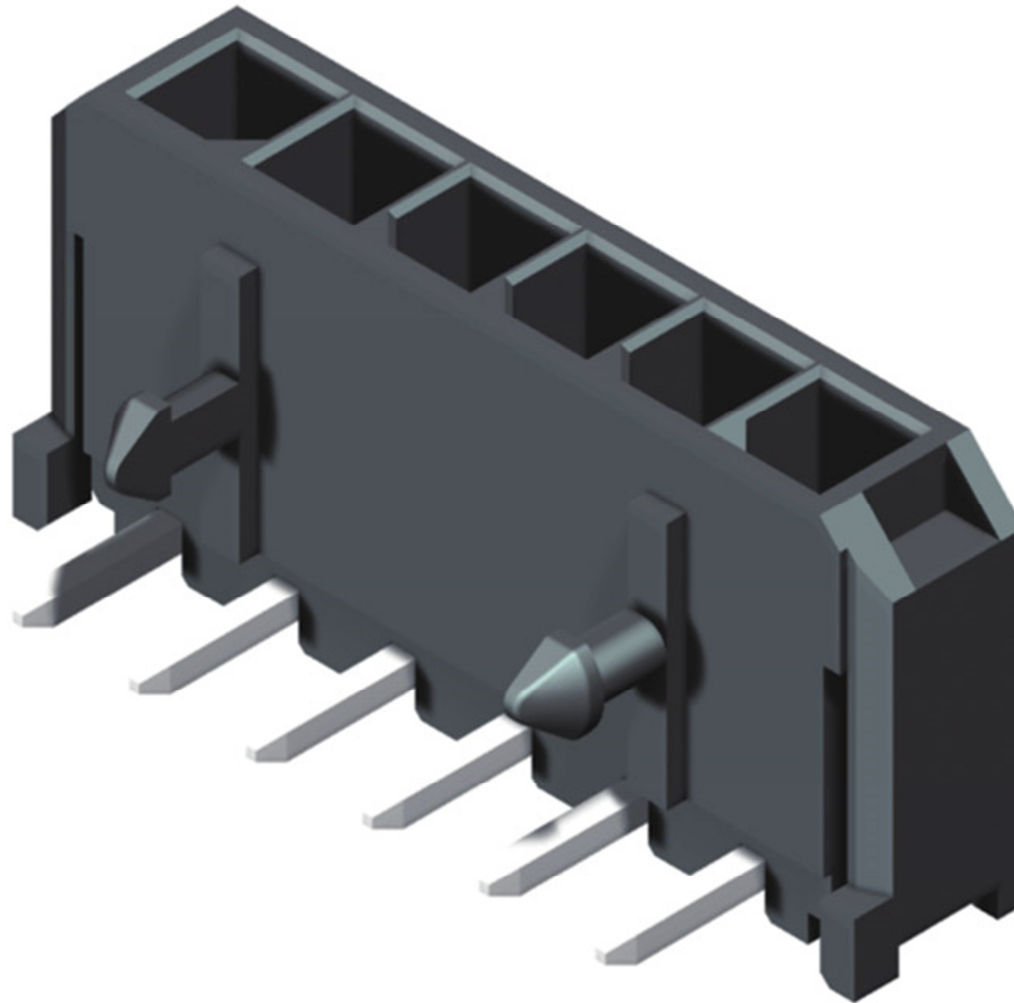

Specification:

Current Rating: 5A AC/DC

Voltage Rating: 250V AC/DC

Temperature Range: -40°C to +105°C

Contact Resistance: 10mΩ Max

Withstanding Voltage: 1500V AC/Minute

Insulation Resistance: 1000mΩ Min

After environmental testing:20mΩ Max

Material

Insulator: PA66,UL94V-0

Insulator: LCP ,UL94V-0

Contact Pin:Brass