

DATASHEET

C0402X7R500-562KNE

GENERAL PURPOSE CERAMIC CAPACITORS (C SERIES)
0402, X7R, 50V, 5600pF, ±10%, 100% matte Tin(Sn) over Nickel



VENKEL LTD.

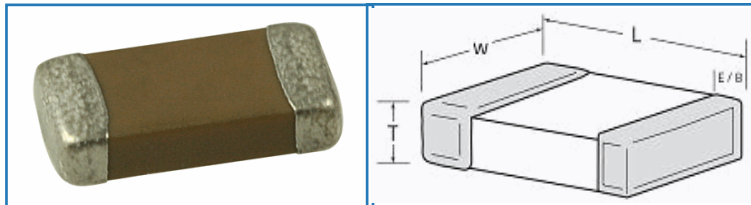

SIZE SPECIFICATIONS units: inches

Length:	0.040
Width:	0.020
T(max):	0.025
Min E/B:	0.004
Size(EIA):	0402

COMPONENT SPECIFICATIONS

Category:	Ceramic Capacitors
Series:	General Purpose (C Series)
Size:	0402
Dielectric:	X7R
Voltage:	50V
Capacitance:	5600pF
Tolerance:	±10%
Termination:	100% matte Tin(Sn) over Nickel
Packaging:	Embossed Tape (7" Reel)
Quantity per Reel:	10,000

DIELECTRIC SPECIFICATIONS

Temperature Coefficient:	0 ±15%Δ°C MAX
Temperature Voltage Coefficient	X7R not applicable
Ageing:	2.5% per decade hour, typical
Withstanding Voltage:	>2.5 times VDCW
Operating Temp:	-55°C to +125°C
Dissipation Factor:	See C Series Datasheet

COMPLIANCE STATUS

RoHS Status	6 of 6 Compliant
REACH Status	Compliant
Halogen Status	Halogen Free
Conflict Mineral Status	Conflict Mineral Free

REEL DIMENSIONS units: mm

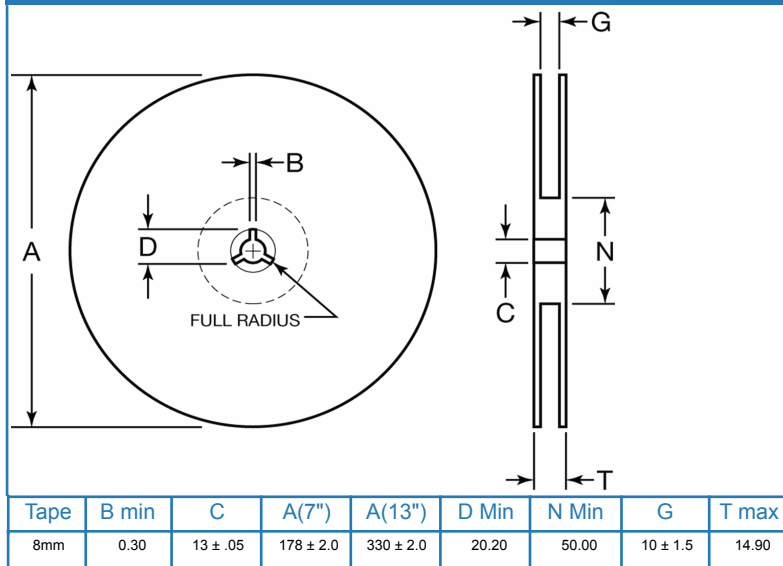

TAPING SPECIFICATIONS units: mm

