

# Chip LED, 0805, Orange

## Feature

- ◆ Viewing angle:140 deg
- ◆ The materials of the chip is AlGaInP
- ◆ 2.00mm×1.25mm×0.70mm
- ◆ RoHS compliant lead-free soldering compatible

CC-OUB0805TS-CE

## Package Outline

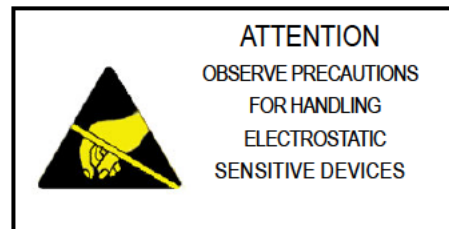
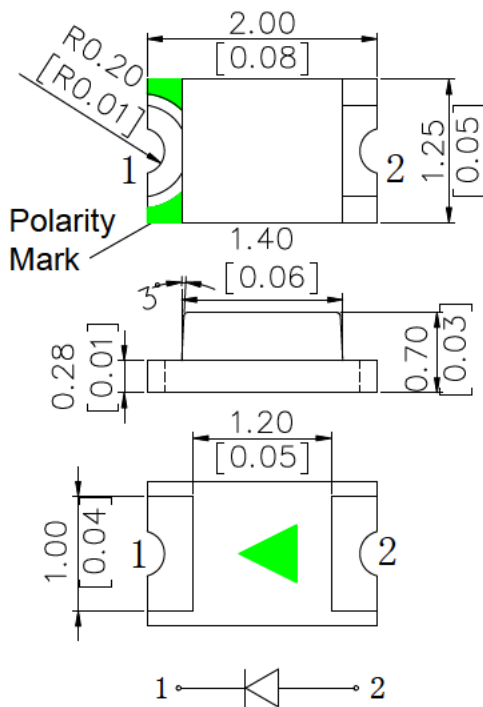

## NOTES:

1. All dimensions are in millimeters (inches);
2. Tolerances are  $\pm 0.1\text{mm}$  (0.004inch) unless otherwise noted.

### Absolute maximum ratings at Ta=25°C

Parameter	Symbol	Value	Unit
Forward current	If	20	mA
Reverse voltage	Vr	5	V
Operating temperature range	Top	-20 ~+85	°C
Storage temperature range	Tstg	-35~+85	°C
Peak pulsing current	Ifp	100	mA
Electrostatic Discharge	ESD	2000(HBM)	V

### Electro-optical characteristics at Ta=25°C

Parameter	Test Condition	Symbol	Value			Unit
			Min.	Typ.	Max.	
Spectral half bandwidth	If=20mA	$\Delta\lambda$	--	15	--	nm
Forward voltage	If=20mA	Vf	1.8	--	1.9	V
			1.9	--	2.0	V
			2.0	--	2.1	V
			2.1	--	2.2	V
			2.2	--	2.3	V
			2.3	--	2.4	V
			2.4	--	2.5	V
Dominant wavelength	If=20mA	$\lambda_d$	615	--	620	nm
			620	--	625	nm
			625	--	630	nm
			630	--	635	nm
Luminous intensity	If=20mA	Iv	70	--	90	mcd
			90	--	120	mcd
			120	--	150	mcd
			150	--	200	mcd
			200	--	260	mcd
Viewing angle at 50% Iv	If=20mA	2 $\theta$ 1/2	--	140	--	Deg
Reverse current	Vr=5V	Ir	--	--	10	$\mu$ A

NOTE: (Tolerance: Iv  $\pm$ 10%,  $\lambda_d$   $\pm$ 2nm, Vf  $\pm$ 0.05V)

IFP Conditions: Pulse Width  $\leq$  10msec. and Duty  $\leq$  1/10.

## Typical optical characteristics curves

Spectral Distribution

Relative Intensity vs. Wavelength (Ta=25°C)

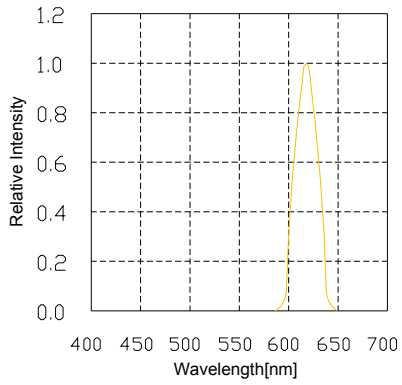

Forward Current vs. Forward Voltage (Ta=25°C)

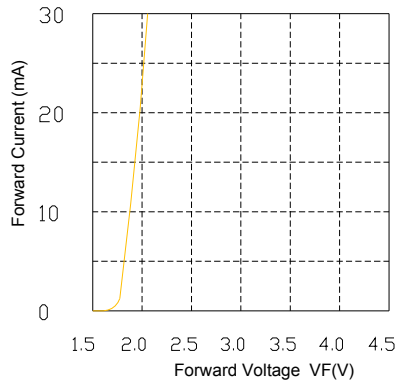

Relative Intensity vs. Forward Current (Ta=25°C)

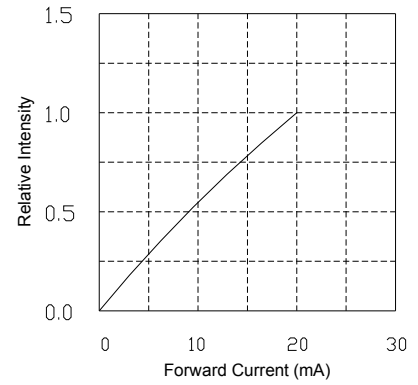

Relative Intensity vs. Ambient Temperature

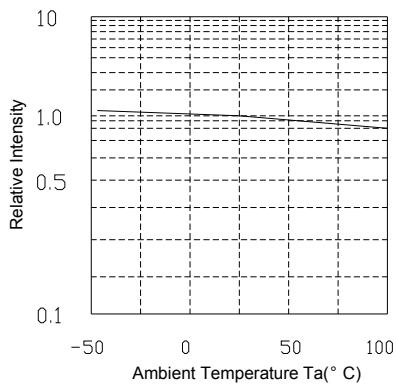

Derating

Maximum Forward Current vs. Ambient Temperature

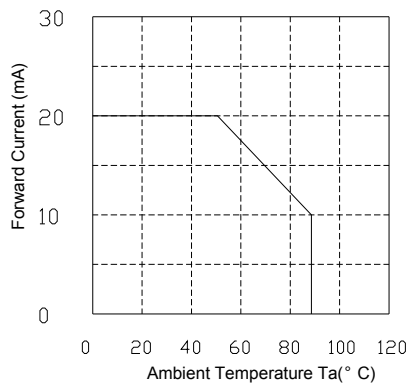

Forward Current vs. Dominate wavelength (Ta=25°C)

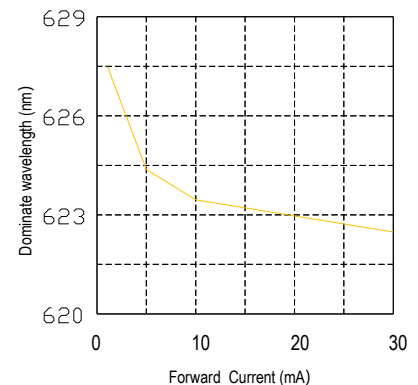
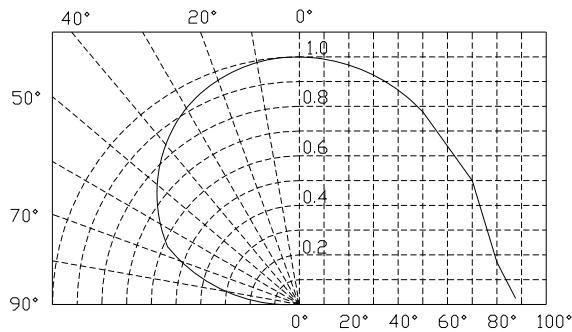

Diagram characteristics of radiation



## Reflow profile

- Soldering condition
  - Recommended soldering conditions

Reflow Soldering		Hand Soldering	
Pre-heat	160~180°C	Temperature	300°C Max.
Pre-heat time	120 seconds Max.	Soldering time	3 second Max. (one time only)
Peak temperature	260°C Max.		
Soldering time	10 seconds Max.		
Condition	Refer to Temperature-profile		

- After reflow soldering rapid cooling should be avoided

■ Temperature-profile (Surface of circuit board)

Use the following conditions shown in the figure.

**RECOMMEND PAD DESIGN (Units: mm)**

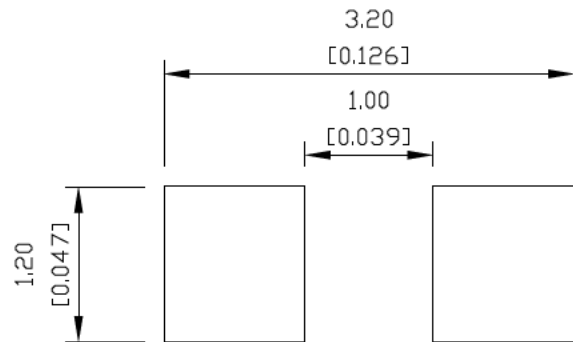
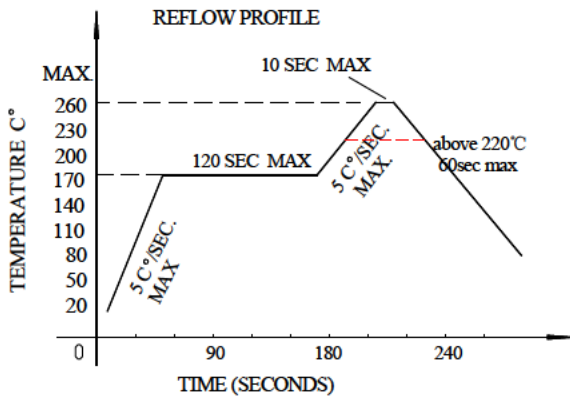

1. Reflow soldering should not be done more than two times
2. When soldering ,do not put stress on the LEDs during heating

■ Soldering iron

1. When hand soldering, keep the temperature of the iron under 300°C, and at that temperature keep the time under 3 sec.
2. The hand soldering should be done only a time
3. The basic spec is ≤5 sec. when the temperature of 260°C, do not contact the resin when hand soldering

■ Rework

1. Customer must finish rework within 5 sec under 260°C
2. The head of iron can not touch the resin
3. Twin-head type is preferred.

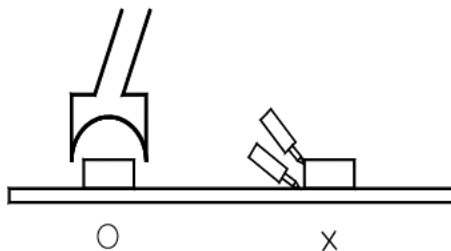

## Reliability

### (1)TEST ITEMS AND RESULTS

Type	Test Item	Ref. Standard	Test Conditions	Note	Number of Damaged
Environmental Sequence	Resistance to Soldering Heat(Reflow Soldering)	JESD22-B106	Tsld=260°C,10sec	2 times	0/22
	Temperature Cycle	JESD22-A104	-40°C 30min 25°C↑↓5min 100°C 30min	300 cycle	0/22
	Thermal Shock	JESD22-A106	-35°C 15min ↑↓ 85°C 15min	300 cycle	0/22
	High Temperature Storage	JESD22-A103	T <sub>a</sub> =100°C	1000 hrs	0/22
	Low Temperature Storage	JESD22-A119	T <sub>a</sub> =-40°C	1000 hrs	0/22
Operation Sequence	Life Test	JESD22-A108	T <sub>a</sub> =25°C I <sub>F</sub> =20mA	1000 hrs	0/22

### (2)CRITERIA FOR JUDGING THE DAMAGE

Item	Symbol	Test Conditions	Criteria for Judgement	
			Min.	Max.
Forward Voltage	VF	IF=20mA	-	U.S.L*)×1.1
Reverse Current	IR	VR=5V	-	U.S.L*)×2.0
Luminous Intensity	IV	IF=20mA	L.S.L**)×0.5	-

U.S.L.: Upper Standard Level

L.S.L.: Lower Standard Level

## NOTES:

- Any reliability test standard change is confidential.

## Packaging Specifications

### ● Feeding Direction

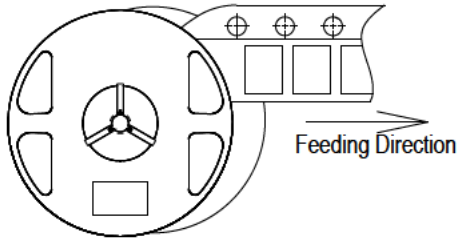

### ● Dimensions of Reel (Unit: mm)

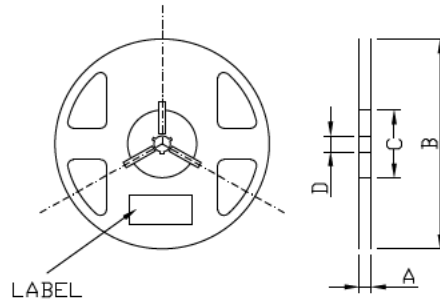

A	$8.0 \pm 0.1\text{mm}$
B	$178 \pm 1\text{mm}$
C	$60 \pm 1\text{mm}$
D	$13.0 \pm 0.5\text{mm}$

### ● Dimensions of Tape (Unit: mm)

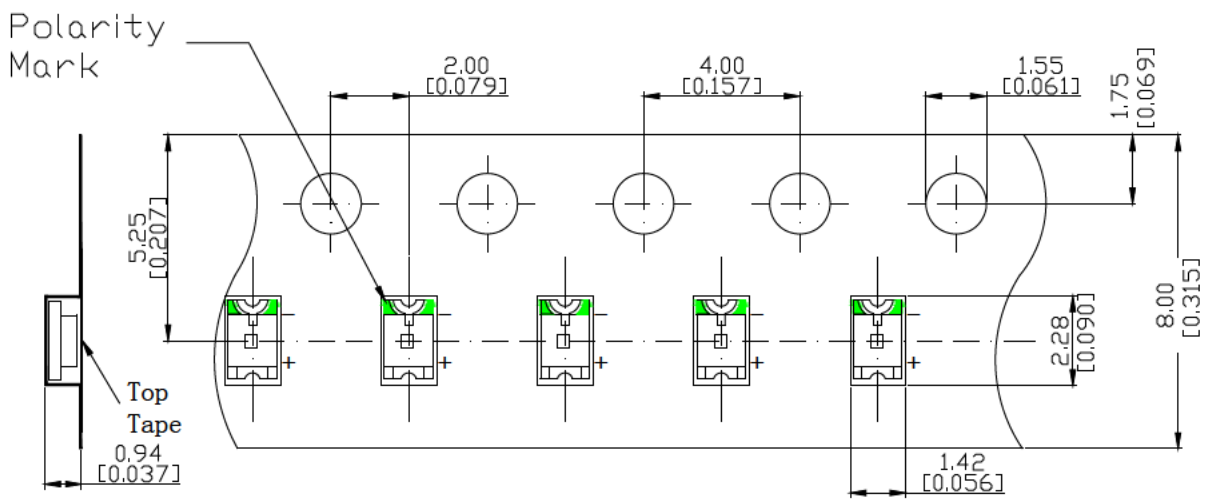

### ● Arrangement of Tape

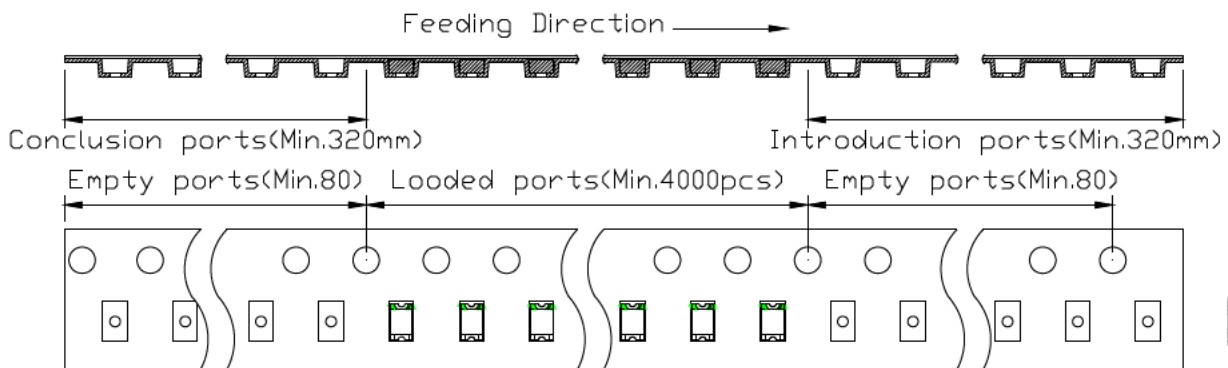

## NOTES

1. Empty component pockets are sealed with top cover tape;
2. The maximum number of missing lamps is two;
3. The cathode is oriented towards the tape sprocket hole in accordance with ANSI/EIA RS-481 specifications.
4. 4,000 pcs/ Reel.

## Packaging specifications

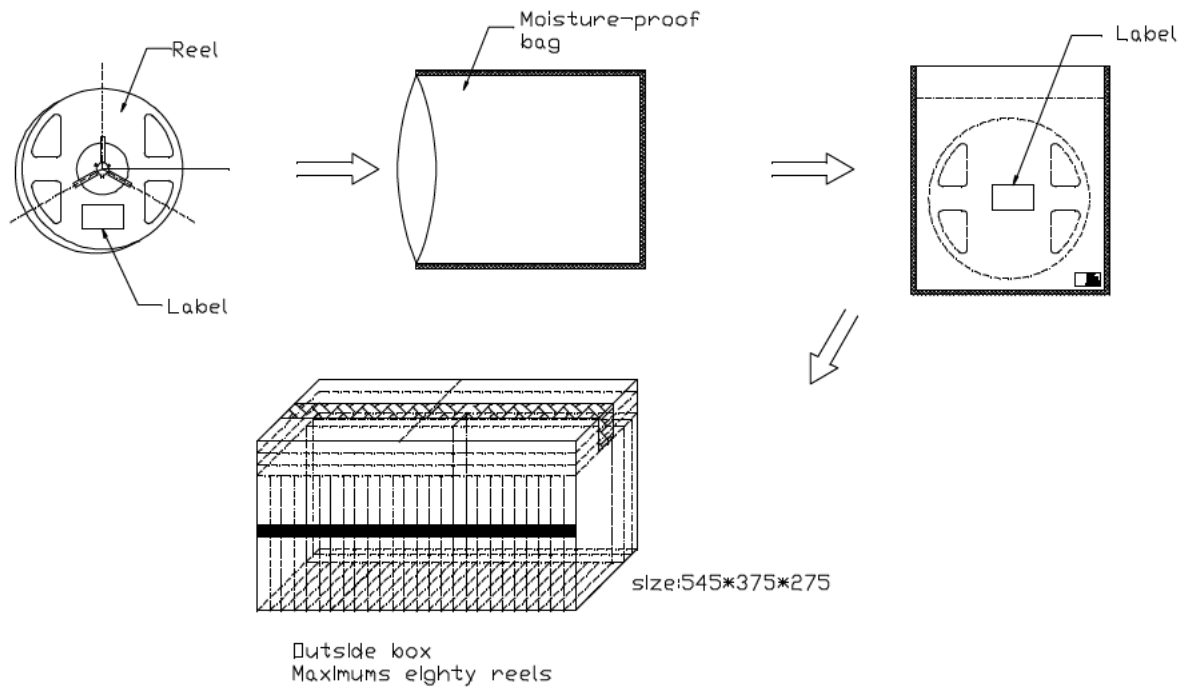

■ Label

PART NO:	
LOT NO:	
	
BIN CODE:	
IV:	
VF:	
WLD:	
QTY:	PCS
DATE:	

## CAUTIONS

### Package specifications

Reeled products (numbers of products are 4,000pcs) packed in a seal off moisture-proof bag along with a desiccant one by one, Eighty moisture-proof bag of maximums are put the outside box (size: about 545mm x about 375mm x about 275mm) Together with buffer material, and it is packed. (Pare No., Lot No., quantity should appear on the label on the moisture-proof bag, part No. And quantity should appear on the label on the cardboard box.) The number of the loading steps of outside box (cardboard box) has two steps.

### Storage conditions

#### Before opening the package:

The LEDs should be kept at 30°C or less and 70%RH or less. The LEDs should be used within a year. When storing the LEDs, moisture proof packaging with absorbent material is recommended.

#### After opening the package:

The LEDs should be kept at 30°C or less and 50%RH or less. The LEDs should be soldered within 168 hours (7days) after opening the package. If unused LEDs remain, they should be stored in moisture proof packages, such as sealed containers with packages of moisture absorbent material. It is also recommended to return the LEDs to the original moisture proof bag and to reseal the moisture proof bag again.