

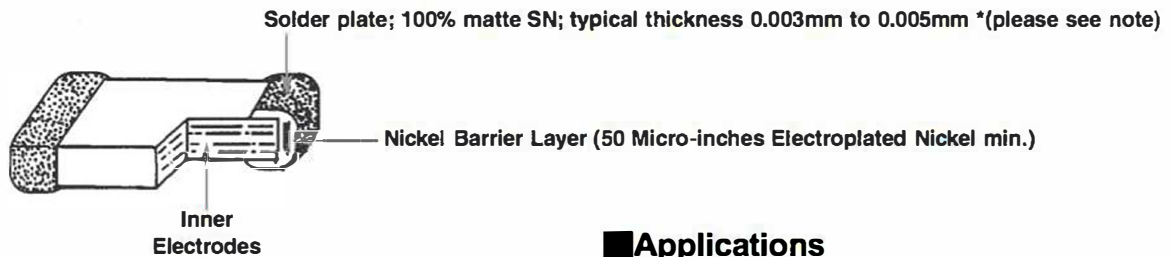

Construction



Introduction

- Constructed by screen printing alternative layers of internal metallic electrodes onto ceramic dielectric materials and firing into a concrete monolithic body, then completed by application of metal end terminations which are fired to assure permanent bonding with the individual internal electrodes

Applications

- Can be used on surface mount assembly equipment
- Our fully integrated manufacturing and total quality control systems ensure unprecedented high standards of quality and reliability.

Features

- Large capacitance values in small sizes
- Excellent high frequency characteristics

Chip Capacitor Selection

DIELECTRIC TYPE

COG (NPO) Capacitance change with temperature is 0-30ppm/°C which is less than -0.3%/°C from -55°C to +125°C. Typical capacitance change with life is less than -0.1% for NPOs, one-fifth that shown by most other dielectrics. NPO formulations show no aging characteristics.

Ultra stable class I dielectric: linear temperature coefficient, low loss, negligible change of electrical properties with time, voltage and frequency.

Operating Temperature Range	Temperature Coefficient	Temperature Voltage Coefficient (ΔC_{Max} @ V_{DCW})	Dissipation Factor	Insulation Resistance	Dielectric withstanding Voltage	Aging Rate	Test Parameters
-55°C to +125°C	0±30ppm/°C	0±30ppm/°C	0.1% Max, 0.02% Typical	<ul style="list-style-type: none"> • 25°C, V_{DCW}:: >100GΩF or 1000ΩF, whichever is less • 125°C, V_{DCW}:: >10GΩF or 100ΩF whichever is less 	3 X V_{DCW}	0% per decade hour	<ul style="list-style-type: none"> • C≤1000pF f=1MHz V=1.0Vrms ±0.2Vrms T=25°C • C>1000pF f=1KHz V=1.0Vrms ±0.2Vrms T=25°C

X7R/X5R Its temperature variation of capacitance is within $\pm 15\%$ from -55°C to $+125^{\circ}\text{C}$ (-55°C to $+85^{\circ}\text{C}$ for X5R). The capacitance change is non-linear.

Stable class II dielectric

Operating Temperature Range	Temperature Coefficient	Temperature Voltage Coefficient (ΔC_{Max} @ V_{DCW})	Dissipation Factor	Insulation Resistance	Dielectric withstanding Voltage	Aging Rate	Test Parameters
X7R = -55C to +125C X5R = -55C to +85C	$\pm 15\%$	X7R/X5R Not Applicable	2.5% Max, 1.8% Typical	<ul style="list-style-type: none"> • 25°C, V_{DCW}: >100GΩFor 1000ΩF, whichever is less • 125°C, V_{DCW}: >10GΩF or 100ΩF whichever is less 	2.5 X V_{DCW}	<2% per decade hour	1KHz, 1.0Vrms ± 0.2 Vrms 25°C values > or = to 10 μ F 1.0Vrms 120Hz

Z5U Despite their capacitance instability, Z5U formulations are very popular because of their small size, temperature range low ESL, low ESR and excellent frequency response. These features are particularly important for decoupling application where only a minimum capacitance value is required.

Y5V Y5V formulations are for general purpose use in a limited temperature range. They have a wide temperature characteristic of $+22\%$ - 82% capacitance change over the operating temperature range of -30°C to $+85^{\circ}\text{C}$. Y5Vs high dielectric constant allows the manufacture of very high capacitance values (up to 22MF) in small physical sizes.

High capacitance per unit volume: general purpose product

Operating Temperature Range	Temperature Coefficient	Dissipation Factor	Insulation Resistance	Dielectric withstanding Voltage	Aging Rate	Test Parameters
-30°C to $+85^{\circ}\text{C}$	$+22\%$ - -82%	3.0% Max, 2.0% Typical	10G Ω or 100 Ω F whichever is less, 25°C , V_{DCW}	2.5 X V_{DCW}	3.0% per decade hour	1KHz, 1Vrms 25°C values > or = to 10 μ F 1.0Vrms 120Hz

CAPACITANCE VALUE & TOLERANCE

Determined by circuit requirements. Note that chip prices decrease with lower capacitance value and looser tolerance.

VOLTAGE

Determined by circuit requirements. Units are designed to exceed the withstanding voltage specification, i.e., the user need not incorporate an additional safety margin.

CAPACITOR SIZE

Select the smallest unit permitted by the circuit constraints that provides the required capacitance and voltage rating. All Cal-Chip capacitors conform to EIA specifications.

CAPACITOR TERMINATION

Nickel barrier is standard and recommended for units exposed to repeated solder cycles, to minimize leaching of the termination.

GMC	21	CG	102	J	50	NT	D
Product Type	Dimensions	Dielectric	Capacitance	Tolerance	Voltage DC	Termination	Packaging Code
	01: 01005 02: 0201 04: 0402 10: 0603 21: 0805 31: 1206 32: 1210 40: 1808 43: 1812 45: 1825 55: 2220 57: 2225	CG: COG/NPO X7R X5R Z5U Y5V	0R5: 0.5pF 5R0: 5.0pF 100: 10pF 101: 100pF 102: 1000pF 103: .01uF 104: .1uF 105: 1.0uF 106: 10uF 107: 100uF	B: +/- .1pF C: +/- .25pF D: +/- .5pF F: +/- 1% G: +/- 2% J: +/- 5% K: +/- 10% M: +/- 20% Z: -20%/+80%	4R0: 4.0V 6R3: 6.3V 10: 10V 16: 16V 25: 25V 35: 35V 50: 50V 63: 63V 100: 100V 200: 200V	NT: Sn/Ni PT: Pd/Ag	Blank: 7" reel D: See Below G: See Below Q: See Below

**Note: Cal-Chip has completed the Lead-Free transition. All parts shipped will be lead-free. The customer designator of "LF" is no longer available. Lead-Free material will continue to have a green RoHS symbol on the label.

PACKAGING 10"/13" REELS ONLY

Type	D	G	Q
0201	50K		
0402	50K		
0603	10K	15K	
0805	10K	15K	20K
1206	10K	15K	20K
1210	4K	8K	10K
1808	8K		
1812	2K	8K	
1825			
2220			
2225			

01005



DIMENSION (MM)		GMC01					
L(L1)		0.4 ± 0.02					
W		0.2 ± 0.02					
H		0.2 ± 0.02					
BW(L2/L3)		0.07 ~ 0.14					
dielectric		NPO/COG		X7R		X5R	Y5V/Z5U
Rated Voltage		6.3	10/16	6.3	10	10	16
Cap. Range							
0.50F	0R5						
1	1R0						
1.2	1R2						
1.5	1R5						
1.8	1R8						
2.2	2R2						
2.7	2R7						
3.3	3R3						
3.9	3R9						
4.7	4R7						
5.6	5R6						
6.8	6R8						
8.2	8R2						
10	100						
11	110						
12	120						
15	150						
18	180						
20	200						
22	220						
27	270						
30	300						
33	330						
39	390						
43	430						
47	470						
51	510						
56	560						
62	620						
68	680						
82	820						
100	101						
120	121						
150	151						
180	181						
220	221						
270	271						
330	331						
390	391						
470	471						
560	561						
680	681						
820	821						
1.0nF	102						
1.2	122						
1.5	152						
1.8	182						
2.2	222						
2.7	272						
3.3	332						
3.9	392						
4.7	472						
5.6	562						
6.8	682						
8.2	822						
10	103						
12	123						
15	153						
18	183						
22	223						
27	273						
33	333						
39	393						
47	473						
56	563						
68	683						
82	823						
100	104						
120	124						

0603

DIMENSION (MM)		GMC10																				
L(L1)		1.6 ± 0.2																				
W		0.8 ± 0.2																				
H		1.0 max																				
BW(L2/LW)		0.1 ~ 0.4																				
dielectric		COG				X5R				X7R						Y5V & Z5U						
Rated Voltage		25	50	100	200	6.3	10	16	25	6.3	10	16	25	50	100	200	6.3	10	16	25	50	
Cap. Range																						
0.5pF	OR5																					
0.4	R40																					
0.47	R47																					
0.7	R70																					
0.75	R75																					
1	1R0																					
1.2	1R2																					
1.3	1R3																					
1.5	1R5																					
1.8	1R8																					
2	2R0																					
2.2	2R2																					
2.4	2R4																					
2.7	2R7																					
3	3R0																					
3.3	3R3																					
3.6	3R6																					
3.9	3R9																					
4	4R0																					
4.3	4R3																					
4.7	4R7																					
5	5R0																					
5.1	5R1																					
5.6	5R6																					
6	6R0																					
6.2	6R2																					
6.8	6R8																					
7	7R0																					
7.5	7R5																					
8	8R0																					
8.2	8R2																					
9	9R0																					
9.1	9R1																					
10	100																					
11	110																					
12	120																					
13	130																					
15	150																					
18	180																					
20	200																					
22	220																					
24	240																					
27	270																					
30	300																					
33	330																					
36	360																					
39	390																					
43	430																					
47	470																					
51	510																					
56	560																					
62	620																					
68	680																					
75	750																					
82	820																					
91	910																					
100	101																					
120	121																					
130	131																					
150	151																					
160	161																					
180	181																					
200	201																					
220	221																					
240	241																					
270	271																					
300	301																					
330	331																					
390	391																					
430	431																					
470	471																					
510	511																					
560	561																					
620	621																					
680	681																					
750	751																					
820	821																					
910	911																					

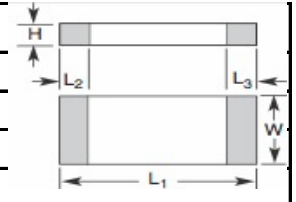

DIMENSION (MM)		GMC10																				
L(L1)		1.6 ± 0.2																				
W		0.8 ± 0.2																				
H		1.0 max																				
BW(L2/LW)		0.1 ~ 0.4																				
dielectric		COG				X5R				X7R								Y5V & Z5U				
Rated Voltage		25	50	100	200	6.3	10	16/25	35	6.3	10	16	25	50	100	200	6.3	10	16	25	50	
Cap. Range																						
1.0nF	102																					
1.2	122																					
1.5	152																					
1.8	182																					
2.2	222																					
2.7	272																					
3.3	332																					
3.9	392																					
4.7	472																					
5.6	562																					
6.8	682																					
7.5	752																					
8.2	822																					
10	103																					
12	123																					
15	153																					
18	183																					
22	223																					
27	273																					
33	333																					
39	393																					
47	473																					
56	563																					
68	683																					
82	823																					
100	104																					
120	124																					
150	154																					
220	224																					
270	274																					
330	334																					
470	474																					
560	564																					
680	684																					
820	824																					
1.0 uF	105																					
2.2	225																					
2.7	275																					
3.3	335																					
3.9	395																					
4.7	475																					
5.6	565																					
6.8	685																					
8.2	825																					
10	106																					
15	156																					
22	226																					
33	336																					
47	476																					

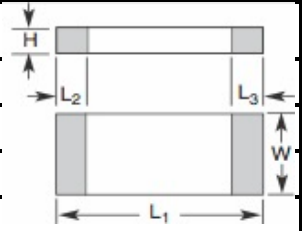

1808 - 2225 (X7R) (cont)

DIMENSION (MM)		GMC40				GMC43				GMC45				GMC55				GMC57								
L(L1)		4.57 ± 0.25				4.5 ± 0.35				4.5 ± 0.35				5.7 ± 0.4				5.7 ± 0.4								
W		4.57 ± 0.25				4.5 ± 0.35				6.3 ± 0.4				5.0 ± 0.4				6.3 ± 0.4								
H		3				3				3.2				3.5				3.5								
BW(L2/L3)		0.25 ~ 0.75				0.25 ~ 0.75				0.25 ~ 0.75				0.25 ~ 0.75				0.25 ~ 0.75								
Rated Voltage		25	50	100	200	10	16	25	50	100	200	16	25	50	100	200	16	25	50	100	200	16	25	50	100	200
Cap. Range																										
82	820																									
100	101																									
120	121																									
150	151																									
180	181																									
220	221																									
270	271																									
330	331																									
390	391																									
470	471																									
560	561																									
680	681																									
820	821																									
1.0nF	102																									
1.2	122																									
1.5	152																									
1.8	182																									
2.2	222																									
2.7	272																									
3.3	332																									
3.9	392																									
4.7	472																									
5.6	562																									
6.8	682																									
8.2	822																									
10	103																									
12	123																									
15	153																									
18	183																									
22	223																									
27	273																									
33	333																									
39	393																									
47	473																									
56	563																									
68	683																									
82	823																									
100	104																									
120	124																									
150	154																									
180	184																									
220	224																									
270	274																									
330	334																									
470	474																									
560	564																									
680	684																									
820	824																									
1.0 uF	105																									
1.2	125																									
1.5	155																									
1.8	185																									
2.2	225																									
3.3	335																									
4.7	475																									
6.8	685																									
10	106																									
22	226																									
33	336																									
47	476																									
68	686																									
100	107																									

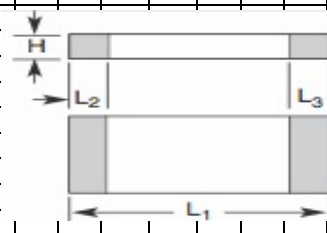

Packaging (Taping)

Per EIA-481

(Reel Type-Size)

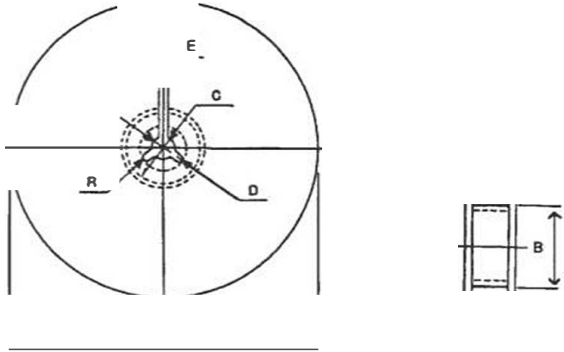

Standard Reel

Unit:mm

A	B	C	D	E	W	t	R
ø178 ±2.0	ø50 min.	ø13.0 ±0.5	ø21.0 ±0.8	2.0 ±0.5	10.2-8mm 14.0-12mm +1.5	0.8 ±0.2	1.0

optional 10/13 inch reels

Unit:mm

A	B	C	D	E	W	t	R
ø330 +2.0	ø50 min.	ø13.0 ±0.5	ø21.0 ±0.8	2.0 ±0.5	10.0 ±1.5	0.8 ±0.2	1.0

- To peel off the cover tape by the method shown in the right figure apply a peel-off force of 20 gf - 60 gf (card board); 10 gf - 75 gf (plastic tape).
- The cover tape should not touch the top or bottom of the chip.
- If the cover tape has been peeled off it may be difficult to remove the chip due to punch-hole clearance, dirt, and debris. Make sure therefore that no paper waste will adhere to and block the absorption nozzle.
- If the cover tape has been peeled off from the top, stick it back on with a suitable adhesive.
- Follow the illustration for the start and end of the winding operation.

Carrier Tape (Standard)

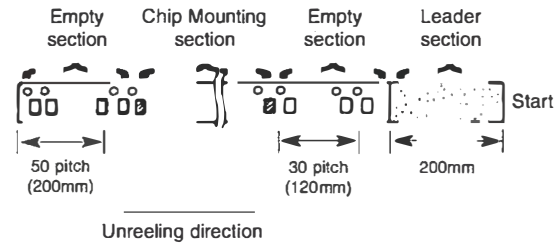
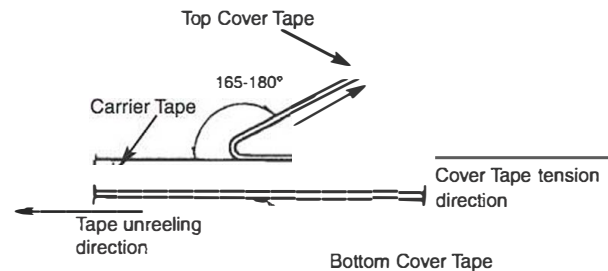

Tape & reel dimensions

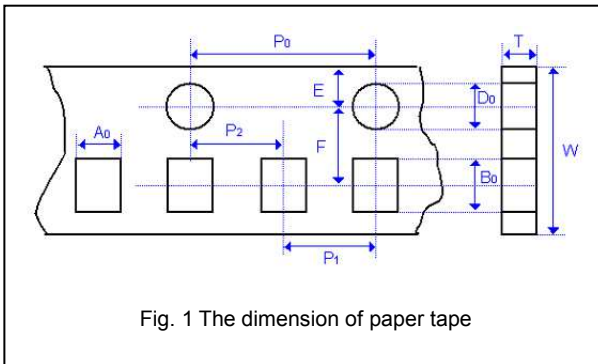

Cardboard carrier tape for 01005, 0201, 0402, 0603, 0805, 1206

Unit=mm

Type	A0	B0	T	Ko	W	P0	10xPo	P1	P2	D0	D1	E	F	Mounting Hole	Std Reel Qty 7"	Optional Reel Qty (10/13")
01005	0.25±0.04	0.45±0.04	0.36±0.05	*	8.0±0.30	4.0±0.10	40.0±0.10	2.0±0.05	2.0±0.05	1.5±0.1	*	1.75±0.1	3.5±0.05	Angular Punch Hole	20,000	50,000
0201	0.39±0.07	0.69±0.07	≤0.50	*	8.0±0.10	4.0±0.10	40.0±0.10	2.0±0.05	2.0±0.05	1.55±0.05	*	1.75±0.05	3.5±0.05		10,000 15,000	50,000
0402	0.7±0.20	1.2±0.20	≤0.80	*	8.0±0.10	4.0±0.10	40.0±0.10	2.0±0.05	2.0±0.05	1.55±0.05	*	1.75±0.05	3.5±0.05		10,000	40,000 50,000
0603	1.1±0.20	1.9±0.20	≤1.20	*	8.0±0.10	4.0±0.10	40.0±0.20	2.0±0.05	2.0±0.05	1.55±0.05	*	1.75±0.05	3.5±0.05		4,000	10,000 15,000
0805	1.65±0.20	2.4±0.20	≤01.30	*	8.0±0.10	4.0±0.10	40.0±0.20	2.0±0.05	2.0±0.05	1.55±0.05	*	1.75±0.05	3.5±0.05		4,000	10,000 15,000 20,000
1206	2.0±0.20	3.6±0.20	≤01.30	*	8.0±0.10	4.0±0.10	40.0±0.20	2.0±0.05	2.0±0.05	1.55±0.05	*	1.75±0.05	3.5±0.05		4,000	10,000 15,000 20,000

■ Tape & reel dimensions

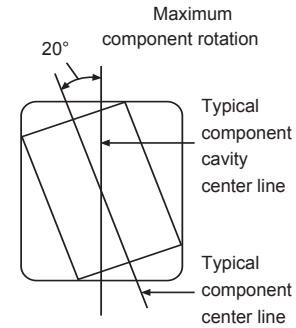
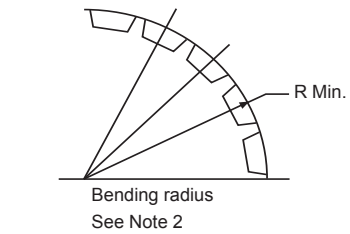
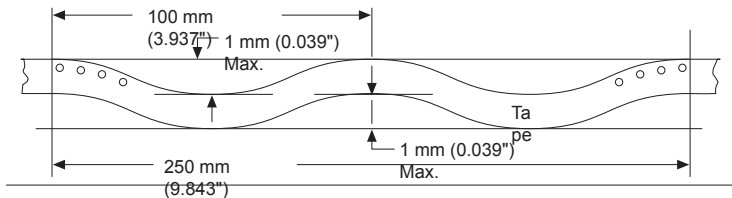
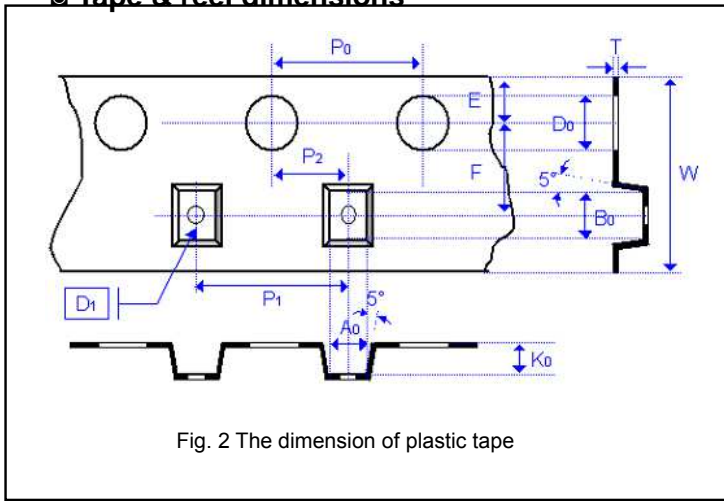

• Embossed plastic carrier tape for 0805/1206/1210/1808/1812/1825/2220 AND 2225 type

Unit=mm

Type	A ₀	B ₀	T	K ₀	W	P ₀	10xP ₀	P ₁	P ₂	D ₀	D ₁	E	F	Mounting Hole	Std Reel Qty 7"	Optional Reel Qty (10/13")
0805	<1.80	<2.70	0.23±0.10	<2.50	8.0±0.20	4.0±0.10	40.0±0.20	4.0±0.10	2.0±0.05	1.5±0.10	1.0±0.10	1.75±0.10	3.5±0.05	Angular Embossed Hole	2,000 3,000	10,000 15,000
1206	<2.30	<4.00	0.23±0.10	<2.50	8.0±0.20	4.0±0.10	40.0±0.20	4.0±0.10	2.0±0.05	1.5±0.10	1.0±0.10	1.75±0.10	3.5±0.05		2,000 3,000	8,000 10,000
1210	<3.20	<3.95	0.23±0.10	<3.00	8.0±0.20	4.0±0.10	40.0±0.20	4.0±0.10	2.0±0.05	1.5±0.10	1.0±0.10	1.75±0.10	3.5±0.05		500 1,000 2,000 3,000	4,000 8,000 10,000
1808	<2.50	<5.30	0.25±0.10	<2.50	12.0±0.20	4.0±0.10	40.0±0.20	4.0±0.10	2.0±0.05	1.5±0.10	1.0±0.10	1.75±0.10	5.5±0.10		1,000 2,000 3,000	6,000 8,000
1812	<3.90	<5.30	0.25±0.10	<3.50	12.0±0.20	4.0±0.10	40.0±0.20	8.0±0.10	2.0±0.05	1.5±0.10	1.5±0.10	1.75±0.10	5.5±0.10	Angular Embossed Hole	500 1,000	2,000
1825	<6.80	<5.30	0.30±0.10	<3.10	12.0±0.20	4.0±0.10	40.0±0.20	8.0±0.10	2.0±0.05	1.5±0.10	1.5±0.10	1.75±0.10	5.5±0.10		500 1,000	1,500
2220	<5.80	<6.50	0.30±0.10	<3.10	12.0±0.20	4.0±0.10	40.0±0.20	8.0±0.10	2.0±0.05	1.5±0.10	1.5±0.10	1.75±0.10	5.5±0.10		500 1,000	1,500
2225	<6.80	<6.50	0.30±0.10	<3.10	12.0±0.20	4.0±0.10	40.0±0.20	8.0±0.10	2.0±0.05	1.5±0.10	1.5±0.10	1.75±0.10	5.5±0.10		500 700	1,000

WARRANTY: All passive components supplied by Calchip Electronics, 59 Steamwhistle Drive, Ivyland, PA. 18974, are under warranty for a period of 2 years from the date of manufacture. Product will meet or exceed all reliability and test specifications expressed by Calchip for the above mentioned time period provided storage conditions (stated below) are met.

Product Storage Instructions:

- 1) Product must be kept away from direct sunlight.
- 2) Product must be stored in the following conditions - Temperature; 5 to 35 degrees Celsius/40 to 95 degrees Fahrenheit
Humidity; 45 to 85%
- 3) Product to be kept free of moisture, dirt and debris.

*******WHEN THESE CONDITIONS ARE NOT MET, PRODUCT LIFE COULD BE SHORTENED*******

NOTICE: Specifications are subject to change without notice. Contact your nearest Cal-Chip Sales Office for the latest specifications. All statements, information and data given herein are believed to be accurate and reliable, but are presented without guarantee, warranty, or responsibility of any kind, expressed or implied. Statements or suggestions concerning possible use of our products are made without representation or warranty that any such use is free of patent infringement and are not recommendations to infringe any patent. The user should not assume that all safety measures are indicated or that other measures may not be required. Specifications are typical and may not apply to all applications.