

**Ultra High Precision Foil Wraparound Surface Mount Chip Resistor  
with TCR of  $\pm 0.05$  ppm/ $^{\circ}$ C and Power Coefficient of 5 ppm at  
Rated Power and Load Life Stability of  $\pm 0.005\%$  (50 ppm)**

**FEATURES**

- Temperature coefficient of resistance (TCR): 0.2 ppm/ $^{\circ}$ C typical ( $-55^{\circ}$ C to  $+125^{\circ}$ C,  $+25^{\circ}$ C ref.)
- Resistance tolerance: to  $\pm 0.01\%$
- Power coefficient “ $\Delta R$  due to self heating”: 5 ppm at rated power
- Power rating: to 750 mW at  $+70^{\circ}$ C (see table 3)
- Load life stability: to  $\pm 0.005\%$  at  $70^{\circ}$ C, 2000 h at rated power
- Resistance range: 5  $\Omega$  to 125 k $\Omega$  (for lower or higher values, please contact us)
- Bulk Metal Foil resistors are not restricted to standard values, we can supply specific “as required” values (e.g. 1K2345 vs. 1K)
- Thermal stabilization time  $< 1$  s (nominal value achieved within 10 ppm of steady state value)
- Electrostatic discharge (ESD) at least to 25 kV
- Short time overload:  $\leq 0.005\%$
- Non inductive, non capacitive design
- Rise time: 1 ns effectively no ringing
- Current noise: 0.010  $\mu V_{RMS}/V$  of applied voltage ( $< -40$  dB)
- Voltage coefficient  $< 0.1$  ppm/V (resistance values above 10 k $\Omega$ )
- Non inductive:  $< 0.08$   $\mu H$
- Non hot spot design
- Terminal finishes available: lead (Pb)-free, tin/lead alloy
- Matched sets are available on request
- Screening in accordance with EEE-INST-002 and MIL-PRF-55342 available (see datasheet resistor models 303133 to 303138)
- Quick prototype quantities available, please contact foil@vpgsensors.com

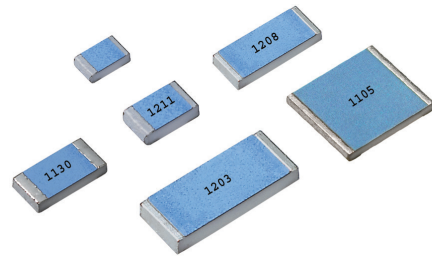

Top View  
(for date code print specification please refer to table 2)



RoHS\*  
COMPLIANT

**INTRODUCTION**

VSMP Series is the industry’s first device to provide high rated power and excellent load life stability along with extremely low TCR – all in one resistor.

One of the most important parameters influencing stability is the Temperature Coefficient of Resistance (TCR). Although the TCR of Bulk Metal® Foil is considered extremely low, this characteristic has been further refined over the years. The VSMP Series utilizes ultra high precision Z Foil. The Z Foil technology provides a significant reduction of the resistive element’s sensitivity to ambient temperature variations (TCR) and to self heating when power is applied (Power Coefficient of Resistance, or PCR). Along with the inherently low PCR and TCR, Z Foil technology also provides remarkably improved load life stability, low noise and tight tolerances.

Vishay Foil Resistors’ (VFR) application engineering department is available to advise and make recommendations. For non-standard technical requirements and special applications, please contact us using the e-mail address in the footer below.

**Table 1 – Tolerance and TCR vs. Resistance Value<sup>(1)</sup> ( $-55^{\circ}$ C to  $+125^{\circ}$ C,  $+25^{\circ}$ C Ref.)**

Resistance value	Tolerance	Typical TCR and max. Spread
250 $\Omega$ to 125 k $\Omega$	$\pm 0.01\%$	$\pm 0.2 \pm 1.8$ ppm/ $^{\circ}$ C
100 $\Omega$ to $< 250$ $\Omega$	$\pm 0.02\%$	$\pm 0.2 \pm 1.8$ ppm/ $^{\circ}$ C
50 $\Omega$ to $< 100$ $\Omega$	$\pm 0.05\%$	$\pm 0.2 \pm 2.8$ ppm/ $^{\circ}$ C
25 $\Omega$ to $< 50$ $\Omega$	$\pm 0.1\%$	$\pm 0.2 \pm 3.8$ ppm/ $^{\circ}$ C
10 $\Omega$ to $< 25$ $\Omega$	$\pm 0.25\%$	$\pm 0.2 \pm 3.8$ ppm/ $^{\circ}$ C
5 $\Omega$ to $< 10$ $\Omega$	$\pm 0.5\%$	$\pm 0.2 \pm 7.8$ ppm/ $^{\circ}$ C

<sup>(1)</sup> For tighter performances and non-standard values lower than 5  $\Omega$  and above 125 k $\Omega$ , please contact application engineering using the e-mail addresses in the footer below

**Figure 1 – Power Derating Curve**

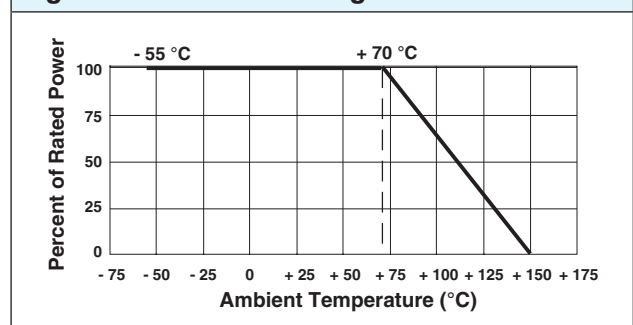

\* This datasheet provides information about parts that are RoHS-compliant and/or parts that are non-RoHS-compliant. For example, parts with lead (Pb) terminations are not RoHS compliant. Please see the information/tables in this datasheet for details.

**Figure 2 – Trimming to Values**  
(Conceptual Illustration)

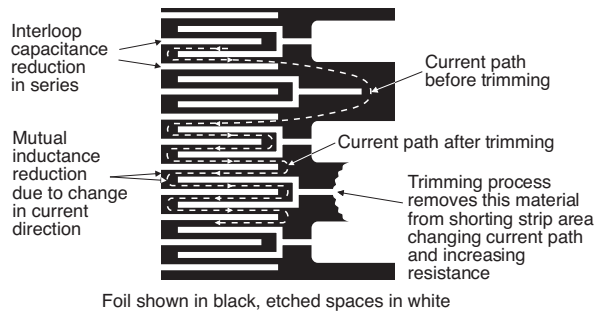

**Note**

To acquire a precision resistance value, the Bulk Metal® Foil chip is trimmed by selectively removing built-in “shorting bars.” To increase the resistance in known increments, marked areas are cut, producing progressively smaller increases in resistance. This method reduces the effect of “hot spots” and improves the long-term stability of Bulk Metal Foil resistors.

**Figure 3 – Typical Resistance / Temperature Curve**

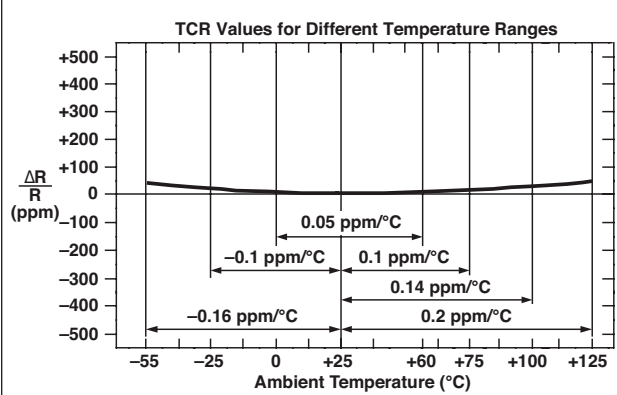

**Note**

The TCR values for <100 Ω are influenced by the termination composition and result in deviation from this curve

**Table 2 – Dimensions and Land Pattern in Inches (Millimeters)**

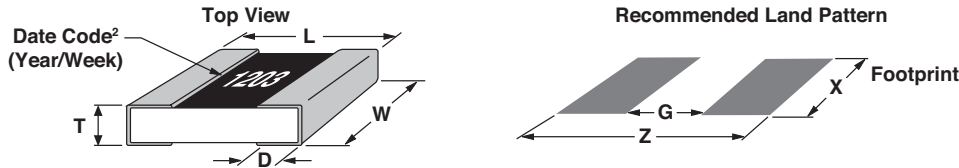

**Note:** Recommended stencil thickness 0.2 mm/0.00787 inch minimum

Chip Size	L ±0.005 (0.13)	W ±0.005 (0.13)	Thickness Maximum	D ±0.005 (0.13)	Z <sup>(1)</sup>	G <sup>(1)</sup>	X <sup>(1)</sup>
0603	0.063 (1.60)	0.032 (0.81)	0.025 (0.64)	0.011 (0.28)	0.102 (2.59)	0.031 (0.78)	0.031 (0.78)
0805	0.080 (2.03)	0.050 (1.27)	0.025 (0.64)	0.015 (0.38)	0.122 (3.10)	0.028 (0.71)	0.050 (1.27)
1206	0.126 (3.20)	0.062 (1.57)	0.025 (0.64)	0.020 (0.51)	0.175 (4.45)	0.059 (1.50)	0.071 (1.80)
1506	0.150 (3.81)	0.062 (1.57)	0.025 (0.64)	0.020 (0.51)	0.199 (5.05)	0.083 (2.11)	0.071 (1.80)
2010	0.198 (5.03)	0.097 (2.46)	0.025 (0.64)	0.025 (0.64)	0.247 (6.27)	0.115 (2.92)	0.103 (2.62)
2512	0.249 (6.32)	0.127 (3.23)	0.025 (0.64)	0.032 (0.81)	0.291 (7.39)	0.150 (3.81)	0.127 (3.23)

<sup>(1)</sup> Land Pattern Dimensions are per IPC-7351A

<sup>(2)</sup> The date code printing applies to all resistor sizes except for 0603

**Table 3 – Specifications**

Chip Size <sup>(1)</sup>	Rated Power at +70°C	Max. Working Voltage (≤√P×R)	Resistance Range <sup>(2)</sup>	Maximum Weight
0603	100 mW	20 V	100 Ω to 5 kΩ	3 mg
0805	200 mW	40 V	5 Ω to 8 kΩ	6 mg
1206	300 mW	87 V	5 Ω to 25 kΩ	12 mg
1506	300 mW	95 V	5 Ω to 30 kΩ	13 mg
2010	500 mW	187 V	5 Ω to 70 kΩ	27 mg
2512	750 mW	220 V	5 Ω to 125 kΩ	40 mg

<sup>(1)</sup> For size 1818, please contact us using the e-mail address in the footer below.

<sup>(2)</sup> For non-standard values please contact application engineering

**Table 4 – Load Life Stability (+70°C for 2000 h)**

Chip Size	ΔR Limits
0603	±0.005% at 50 mW ±0.01% at 100 mW
0805	±0.005% at 100 mW ±0.01% at 200 mW
1206, 1506	±0.005% at 150 mW ±0.01% at 300 mW
2010	±0.005% at 200 mW ±0.01% at 500 mW
2512	±0.005% at 500 mW ±0.01% at 750 mW

**Table 5—Performances**

Test or Conditions	MIL-PRF-55342 Characteristic E $\Delta R$ Limits	Typical $\Delta R$ Limits	Performance $\Delta R$ Limits <sup>(1)</sup>
Thermal Shock, 100x (-65°C to +150°C)	±0.1%	±0.005% (50 ppm)	±0.01% (100 ppm)
Low Temperature Operation, -65°C, 45 min at P <sub>nom</sub>	±0.1%	±0.005% (50 ppm)	±0.01% (100 ppm)
Short Time Overload, 6.25x Rated Power, 5 s	±0.1%	±0.005% (50 ppm)	±0.01% (100 ppm)
High Temperature Exposure, +150°C, 100 h	±0.1%	±0.01% (100 ppm)	±0.02% (200 ppm)
Resistance to Soldering Heat	±0.2%	±0.005% (50 ppm)	±0.01% (100 ppm)
Moisture Resistance	±0.2%	±0.005% (50 ppm)	±0.02% (200 ppm)
Load Life Stability +70°C for 2000 h at Rated Power	±0.5%	±0.005% (50 ppm)	±0.01% (100 ppm)

<sup>(1)</sup> As shown +0.01  $\Omega$  to allow for measurement errors at low values

**Figure 4—Recommended Mounting**

1. IR and vapor phase reflow are recommended.
2. Avoid the use of cleaning agents that attack epoxy resins, which form part of the resistor construction.
3. Vacuum pick up is recommended for handling.
4. If the use of a soldering iron becomes necessary, precautionary measures should be taken to avoid any possible damage/overheating of the resistor.

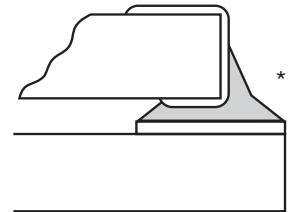

\* Recommendation: The solder fillet profile should be such as to avoid running over the top metallization.

**Figure 5—VSMP0603 100 Cycle Thermal Shock -65°C to 150°C, 10 Units Each Value**

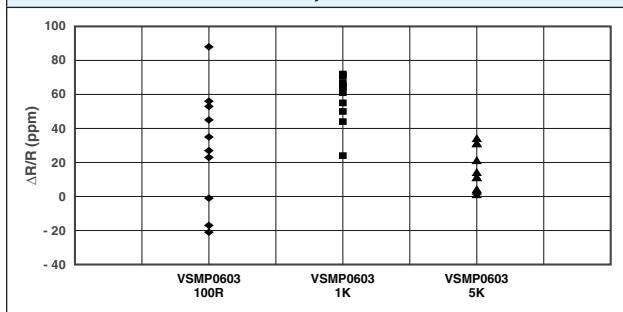

**Figure 6—Load Life Test for 10,000 hrs @0.3 W, +70°C; VsmP 1206, N=40**

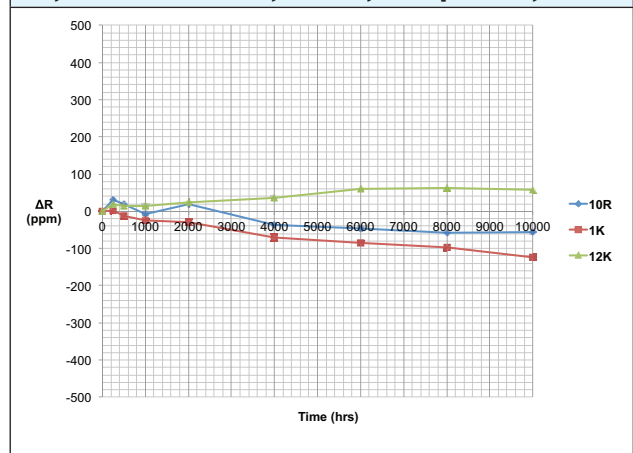

## PULSE TEST

### Test Description

All parts are baked at +125°C for 1 hour and allowed to cool at room temperature for 1 hour, prior to testing. By using an electrolytic 0.01 μF capacitor charged to 1200 VDC, a single pulse was performed on 30 units of 1206, 10 kΩ of Surface Mount Bulk Metal® Foil resistor and Thin Film resistor. The units were allowed time to cool down, after which the resistance measurements were taken and displayed in ppm deviation from the initial reading.

### Test Results

**Figure 7—Pulse Test Description**

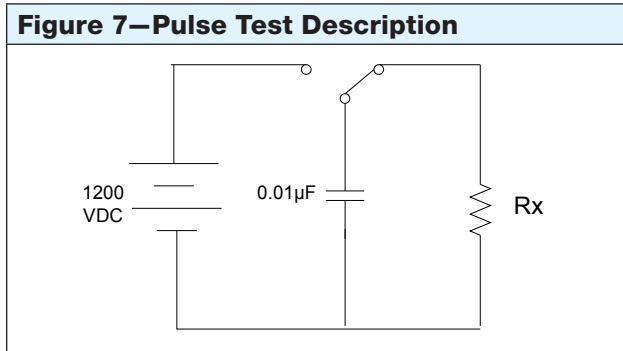

**Figure 8—Pulse Test Results at 1200 VDC\***

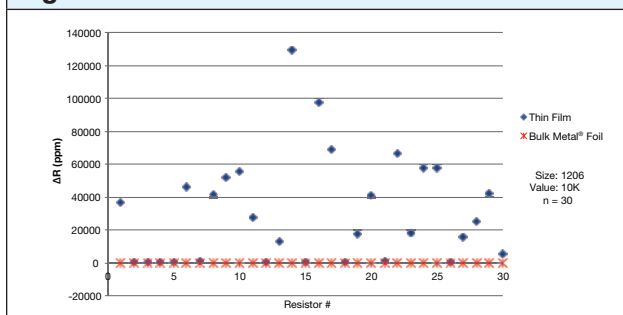

\* Note Average of 30 units yielded deviation of 30,723 ppm of the Thin Film vs. -14 ppm for the Bulk Metal® Foil

## ELECTROSTATIC DISCHARGE (ESD)

ESD can be categorized into three types of damages:

**Parametric Failure** – occurs when the ESD event alters one or more device parameters (resistance in the case of resistors), causing it to shift from its required tolerance. This failure does not directly pertain to functionality; thus a parametric failure may be present while the device is still functional.

**Catastrophic Damage** – occurs when the ESD event causes the device to immediately stop functioning. This may occur after one or a number of ESD events with diverse causes, such as human body discharge or the mere presence of an electrostatic field.

**Latent Damage** – occurs when the ESD event causes moderate damage to the device, which is not noticeable, as the device appears to be functioning correctly. However, the load life of the device has been dramatically reduced, and further degradation caused by operating stresses may cause the device to fail during service. Latent damage is the source for greatest concern, since it is very difficult to detect by re-measurement or by visual inspection, because damage may have occurred under the external coating.

### Test Description

By using an electrolytic 500 pF capacitor charged up to 4500 V, pulses were performed on 10 units of 1206, 10 kΩ of three different Surface Mount Chip Resistors technologies, with an initial voltage spike of 2500 V (Figure 10). The units were allowed time to cool down, after which the resistance measurements were taken and displayed in ppm deviation from the initial readings. Readings were then taken in 500 V increments up to 4500 V.

**Figure 9—ESD Test Description**

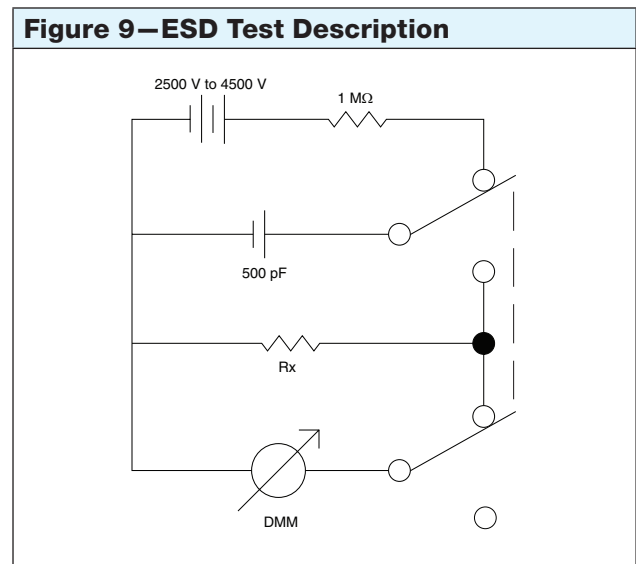
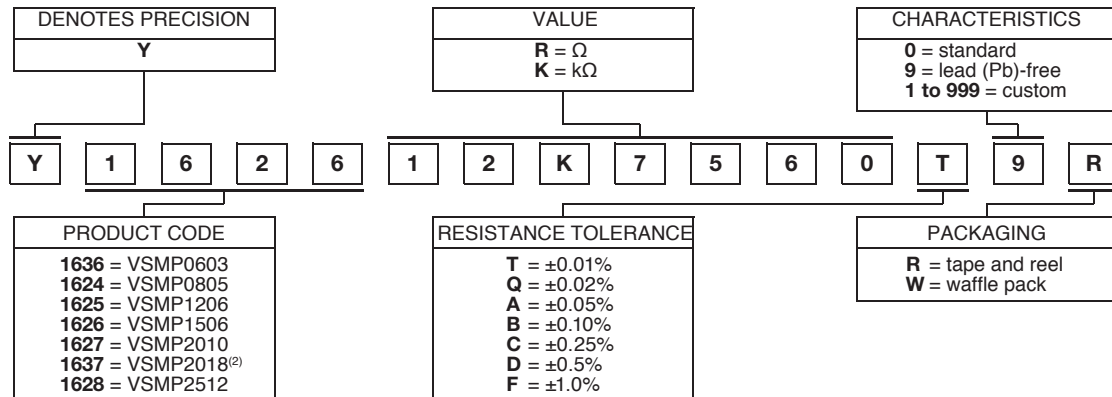

**Table 6—ESD Test Results  
(Average of 10 Units)**

	ΔR		
	Thick Film	Thin Film	Bulk Metal Foil
2500 V	-2.7%	97%	<0.005%
3000 V	-4.2%	366%	<0.005%
3500 V	-6.2%	Open	<0.005%
4000 V	-7.4%	Open	<0.005%
4500 V	-8.6%	Open	<0.005%

**Table 7 – Global Part Number Information<sup>(1)</sup>**

**NEW GLOBAL PART NUMBER: Y162612K7560T9R (preferred part number format)**



FOR EXAMPLE: ABOVE GLOBAL ORDER Y1626 12K7560 T 9 R:

TYPE: VSMP1506  
VALUES: 12.7560 kΩ  
ABSOLUTE TOLERANCE: 0.01%  
TERMINATION: lead (Pb)-free  
PACKAGING: tape and reel

**HISTORICAL PART NUMBER: VSMP1506 12K756 TCR0.2 T S T (will continue to be used)**

VSMP1506	12K756	TCR0.2	T	S	T
MODEL	RESISTANCE VALUE	TCR CHARACTERISTICS	TOLERANCE	TERMINATION	PACKAGING
VSMP0603 VSMP0805 VSMP1206 VSMP1506 VSMP2010 VSMP2018 <sup>(2)</sup> VSMP2512	12.756 kΩ		T = ±0.01% Q = ±0.02% A = ±0.05% B = ±0.10% C = ±0.25% D = ±0.5% F = ±1.0%	S = lead (Pb)-free B = tin/lead	T = tape and reel W = waffle pack

<sup>(1)</sup> For non-standard requests, please contact application engineering.

<sup>(2)</sup> For size 2018, please contact us

## PRECISION CENTER

Precision centers are located around the world to provide in any ohmic value (no MOQ) local, short run, quick delivery of Bulk Metal<sup>®</sup> Foil resistors.

Since Bulk Metal Foil is not restricted to standard values and each resistor is trimmed to the precise value ordered, the unique chain of Precision Centers brings these precise values as close as possible to the circuit designers in the shortest time possible.

For your local Precision Center please click [here](#).



## **Disclaimer**

ALL PRODUCTS, PRODUCT SPECIFICATIONS AND DATA ARE SUBJECT TO CHANGE WITHOUT NOTICE.

Vishay Precision Group, Inc., its affiliates, agents, and employees, and all persons acting on its or their behalf (collectively, "VPG"), disclaim any and all liability for any errors, inaccuracies or incompleteness contained herein or in any other disclosure relating to any product.

The product specifications do not expand or otherwise modify VPG's terms and conditions of purchase, including but not limited to, the warranty expressed therein.

VPG makes no warranty, representation or guarantee other than as set forth in the terms and conditions of purchase. **To the maximum extent permitted by applicable law, VPG disclaims (i) any and all liability arising out of the application or use of any product, (ii) any and all liability, including without limitation special, consequential or incidental damages, and (iii) any and all implied warranties, including warranties of fitness for particular purpose, non-infringement and merchantability.**

Information provided in datasheets and/or specifications may vary from actual results in different applications and performance may vary over time. Statements regarding the suitability of products for certain types of applications are based on VPG's knowledge of typical requirements that are often placed on VPG products. It is the customer's responsibility to validate that a particular product with the properties described in the product specification is suitable for use in a particular application. You should ensure you have the current version of the relevant information by contacting VPG prior to performing installation or use of the product, such as on our website at [vpgsensors.com](http://vpgsensors.com).

No license, express, implied, or otherwise, to any intellectual property rights is granted by this document, or by any conduct of VPG.

The products shown herein are not designed for use in life-saving or life-sustaining applications unless otherwise expressly indicated. Customers using or selling VPG products not expressly indicated for use in such applications do so entirely at their own risk and agree to fully indemnify VPG for any damages arising or resulting from such use or sale. Please contact authorized VPG personnel to obtain written terms and conditions regarding products designed for such applications.

Product names and markings noted herein may be trademarks of their respective owners.

Copyright Vishay Precision Group, Inc., 2014. All rights reserved.