

**GLASS PASSIVATED
JUNCTION PLASTIC RECTIFIER**

VOLTAGE RANGE 50 to 1000 Volts CURRENT 3.0 Amperes

FEATURES

- * High reliability
- * Low leakage
- * Low forward voltage drop
- * High current capability
- * Glass passivated junction

MECHANICAL DATA

- * Case: Molded plastic
- * Epoxy: Device has UL flammability classification 94V-0
- * Lead: MIL-STD-202E method 208C guaranteed
- * Mounting position: Any
- * Weight: 1.18 grams

MAXIMUM RATINGS AND ELECTRICAL CHARACTERISTICS

Ratings at 25 °C ambient temperature unless otherwise specified.
Single phase, half wave, 60 Hz, resistive or inductive load.
For capacitive load, derate current by 20%.

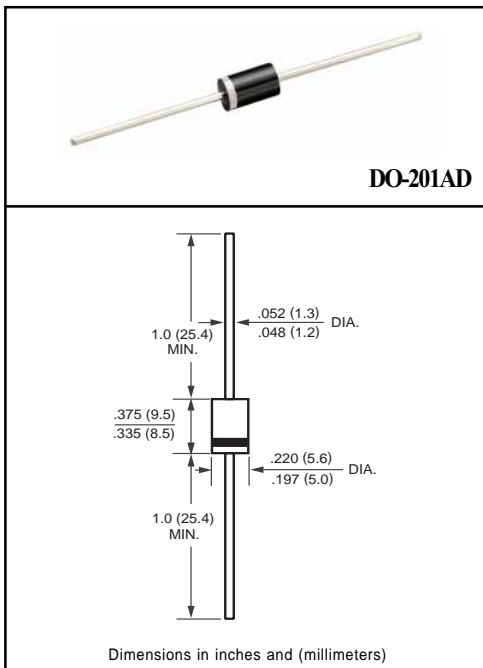

MAXIMUM RATINGS (At TA = 25°C unless otherwise noted)

RATINGS	SYMBOL	1N5400G	1N5401G	1N5402G	1N5404G	1N5406G	1N5407G	1N5408G	UNITS
Maximum Recurrent Peak Reverse Voltage	VRRM	50	100	200	400	600	800	1000	Volts
Maximum RMS Voltage	VRMS	35	70	140	280	420	560	700	Volts
Maximum DC Blocking Voltage	Vdc	50	100	200	400	600	800	1000	Volts
Maximum Average Forward Rectified Current .375" (9.5mm) lead length at TL = 105°C	Io	3.0							Amps
Peak Forward Surge Current 8.3 ms single half sine-wave superimposed on rated load (JEDEC method)	IFSM	150							Amps
Typical Junction Capacitance (Note)	CJ	40							pF
Typical Thermal Resistance	RθJA	30							°C/W
Operating and Storage Temperature Range	TJ, TSTG	-55 to + 150							°C

ELECTRICAL CHARACTERISTICS (At TA = 25°C unless otherwise noted)

CHARACTERISTICS	SYMBOL	1N5400G	1N5401G	1N5402G	1N5404G	1N5406G	1N5407G	1N5408G	UNITS
Maximum Instantaneous Forward Voltage at 3.0A DC	VF	1.1							Volts
Maximum DC Reverse Current at Rated DC Blocking Voltage	@TA = 25°C	5.0							uAmps
	@TA = 100°C	300							
Maximum Full Load Reverse Current Average, Full Cycle .375" (9.5mm) lead length at TL = 75°C	IR	30							uAmps

NOTES : Measured at 1 MHz and applied reverse voltage of 4.0 volts

RATING AND CHARACTERISTIC CURVES (1N5400G THRU 1N5408G)

FIG. 1 - TYPICAL FORWARD CURRENT DERATING CURVE

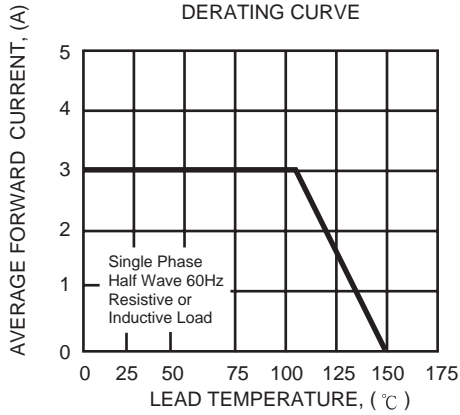

FIG. 2 - TYPICAL INSTANTANEOUS FORWARD CHARACTERISTICS

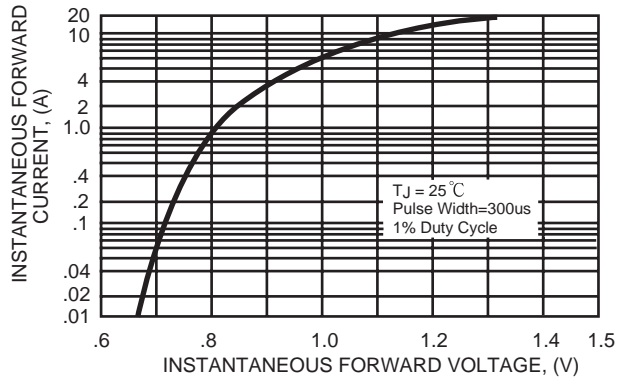

FIG. 3 - MAXIMUM NON-REPETITIVE FORWARD SURGE CURRENT

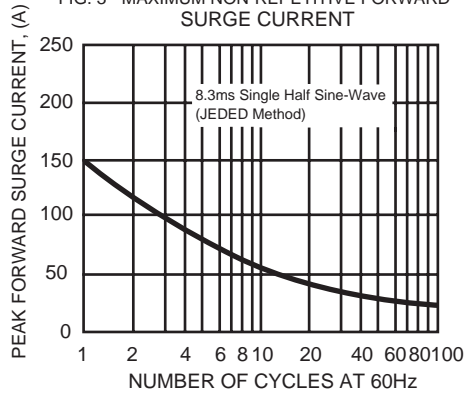

FIG. 4 - TYPICAL REVERSE CHARACTERISTICS

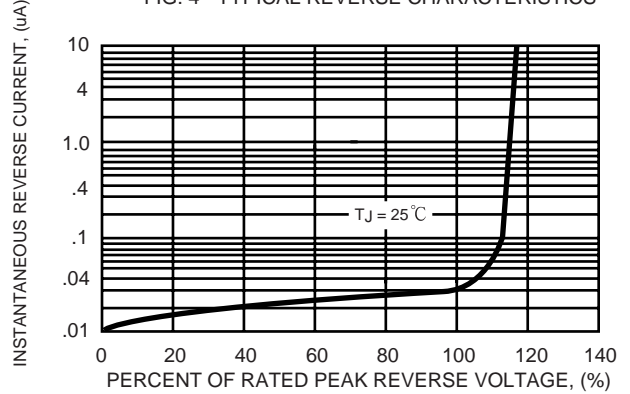

FIG. 5 - TYPICAL JUNCTION CAPACITANCE

