

Product Group Chart

Organic Conductive Polymer Capacitors (OP-CAP)

SMD Type

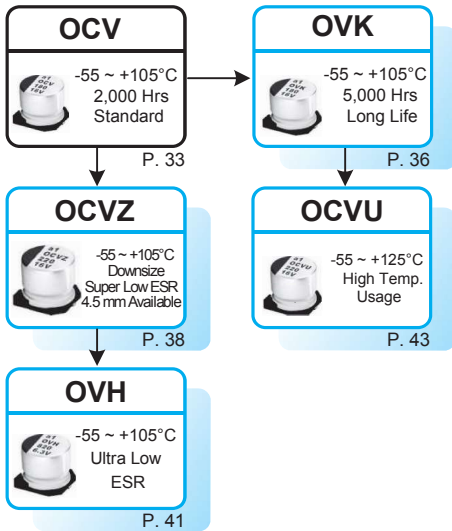

Radial Type

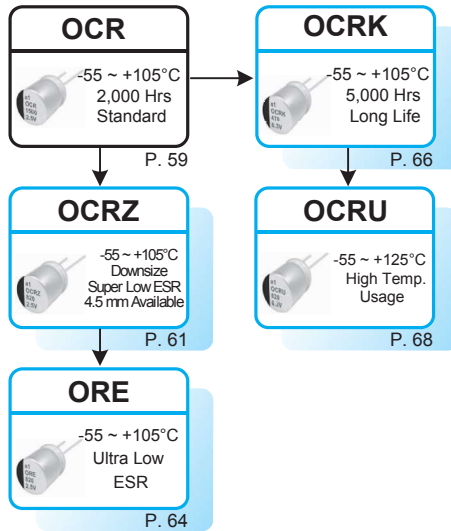

Organic Conductive Polymer Capacitors (OP-CAP*)



SMD Type

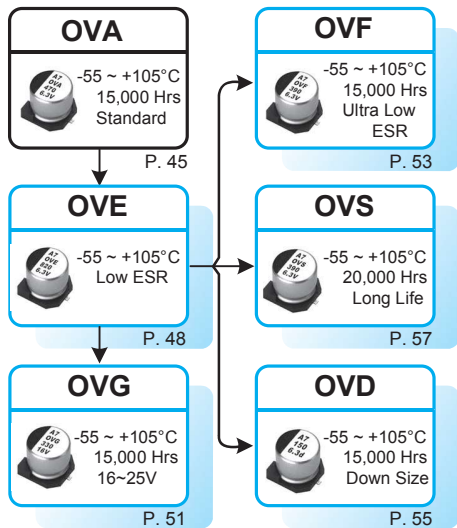

Radial Type

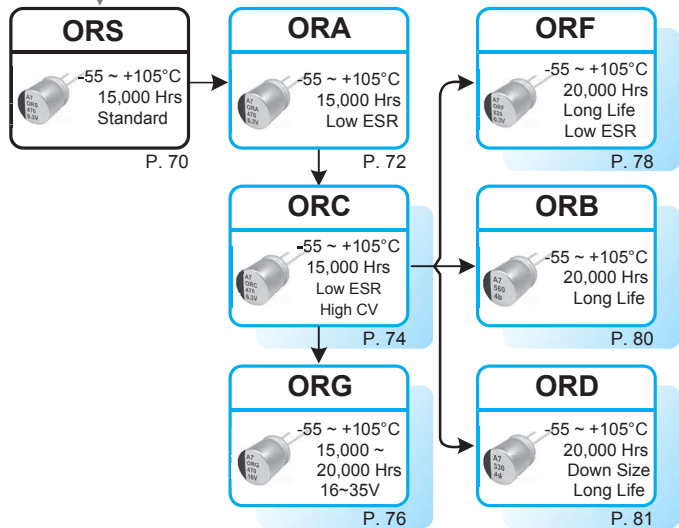

Conductive Polymer Hybrid Capacitors

SMD Type

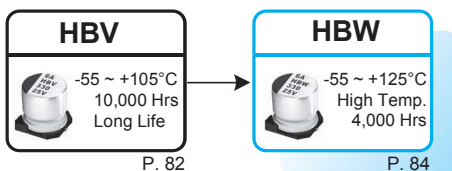

Radial Type

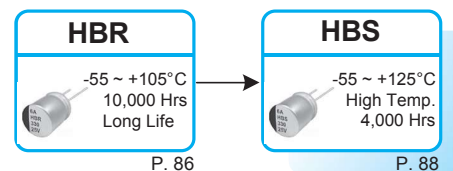

● SMD Aluminum Electrolytic Capacitors

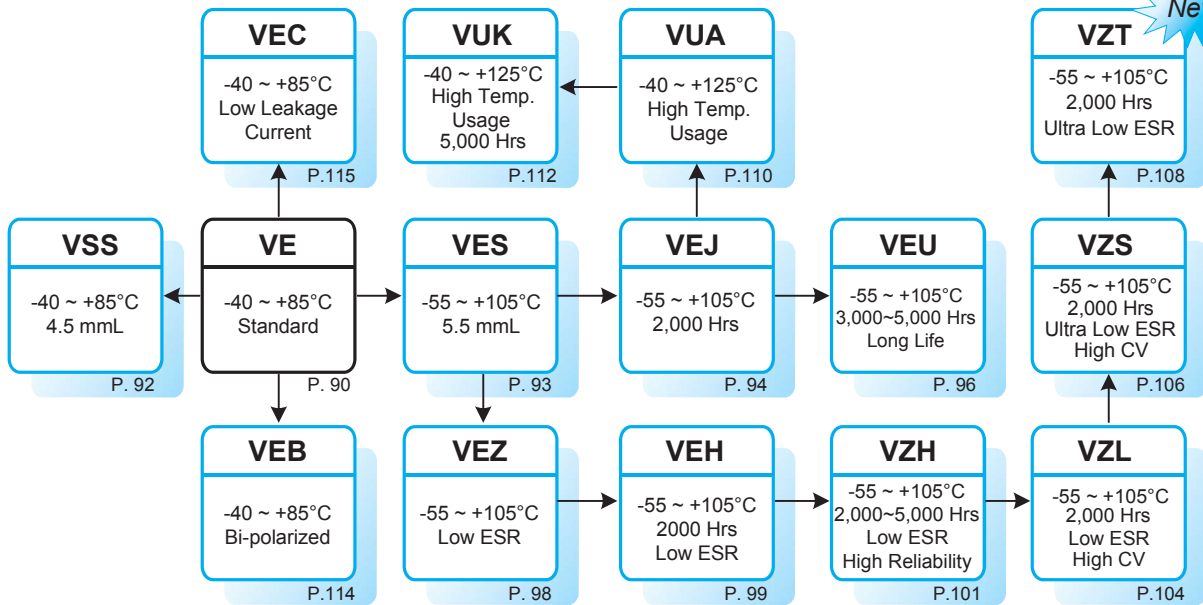

● Radial Type

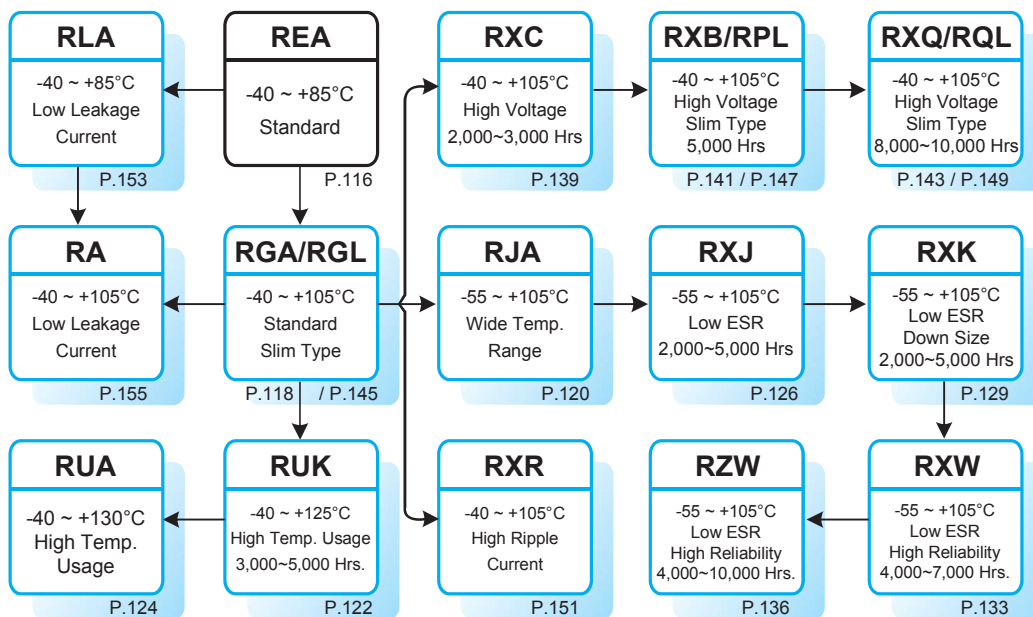

● Flame Retardant

Snap-in Type

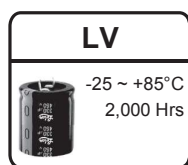

P.218



P.218

Radial Type

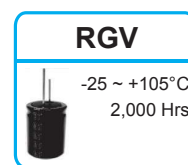

P.157

● Radial - 7mmL and 5mmL

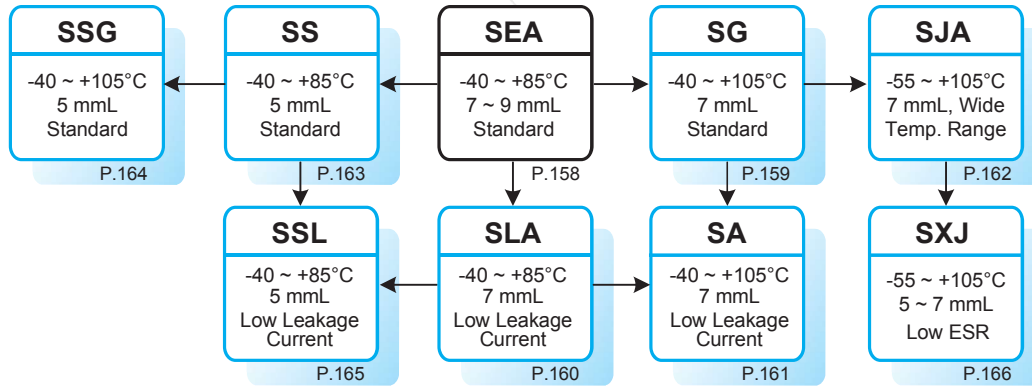

● Snap-in Terminal

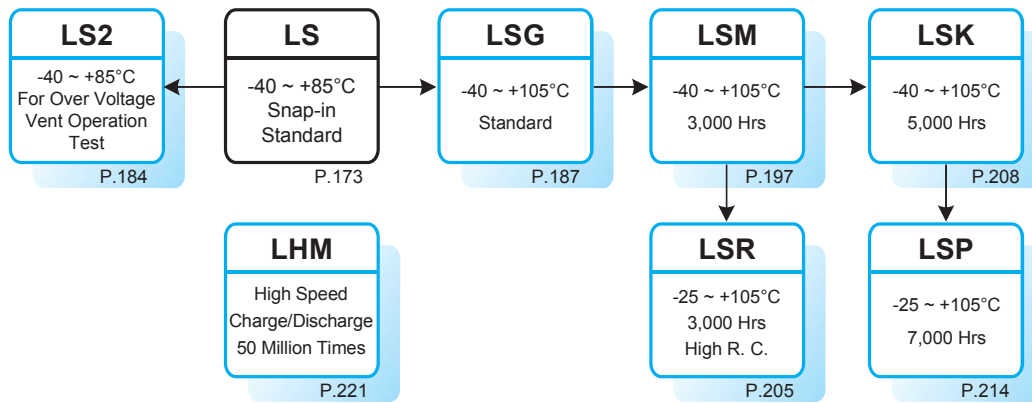

● Screw Terminal

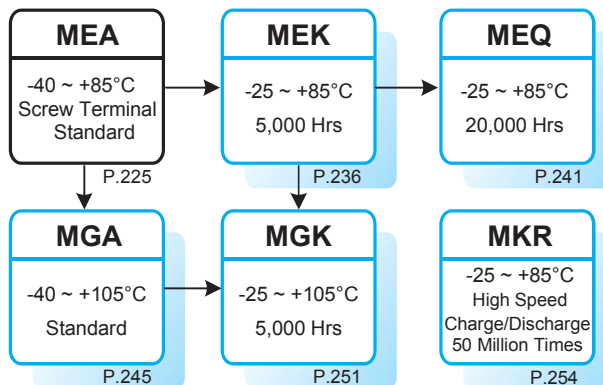

● Bi-polarized

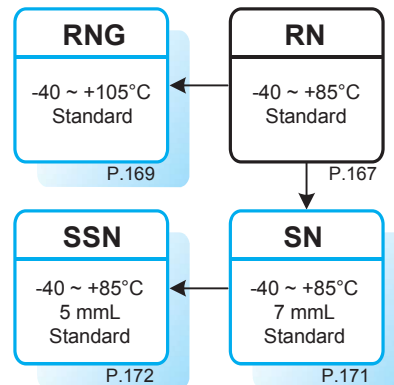

● Axial

