

**Chip Monolithic  
Ceramic Capacitors  
for DC-DC Converters**

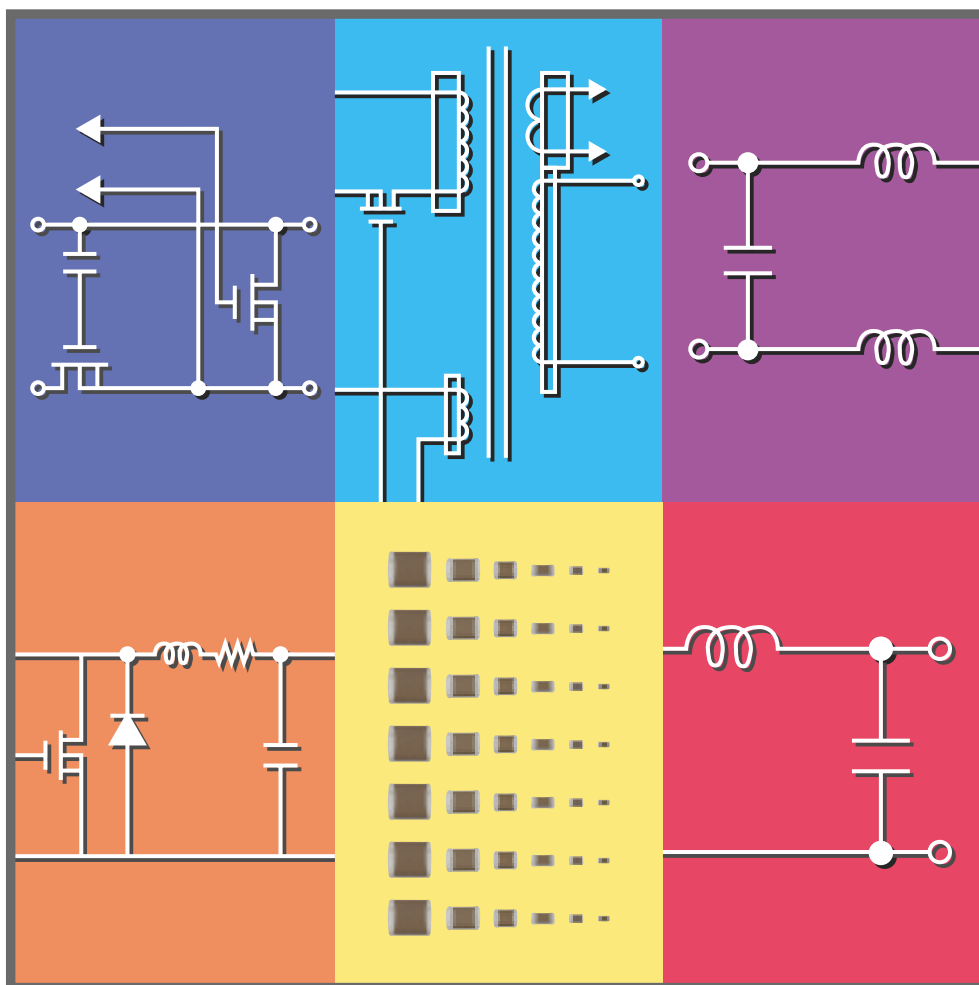

*Innovator in Electronics*



# Murata's extensive and complete chip capacitor line up enables your DC-DC converters and voltage regulators to be compact and high performed.

As the industry leader, Murata offers this complete monolithic ceramic capacitor line up for all your DC-DC converter and voltage regulator needs. All the parts below incorporate our latest thin film and base metal technology, to provide high performance, reliable and cost competitive components. We are committed to providing the most optimal component solutions for all of our customers' needs.

## DC-DC Converters

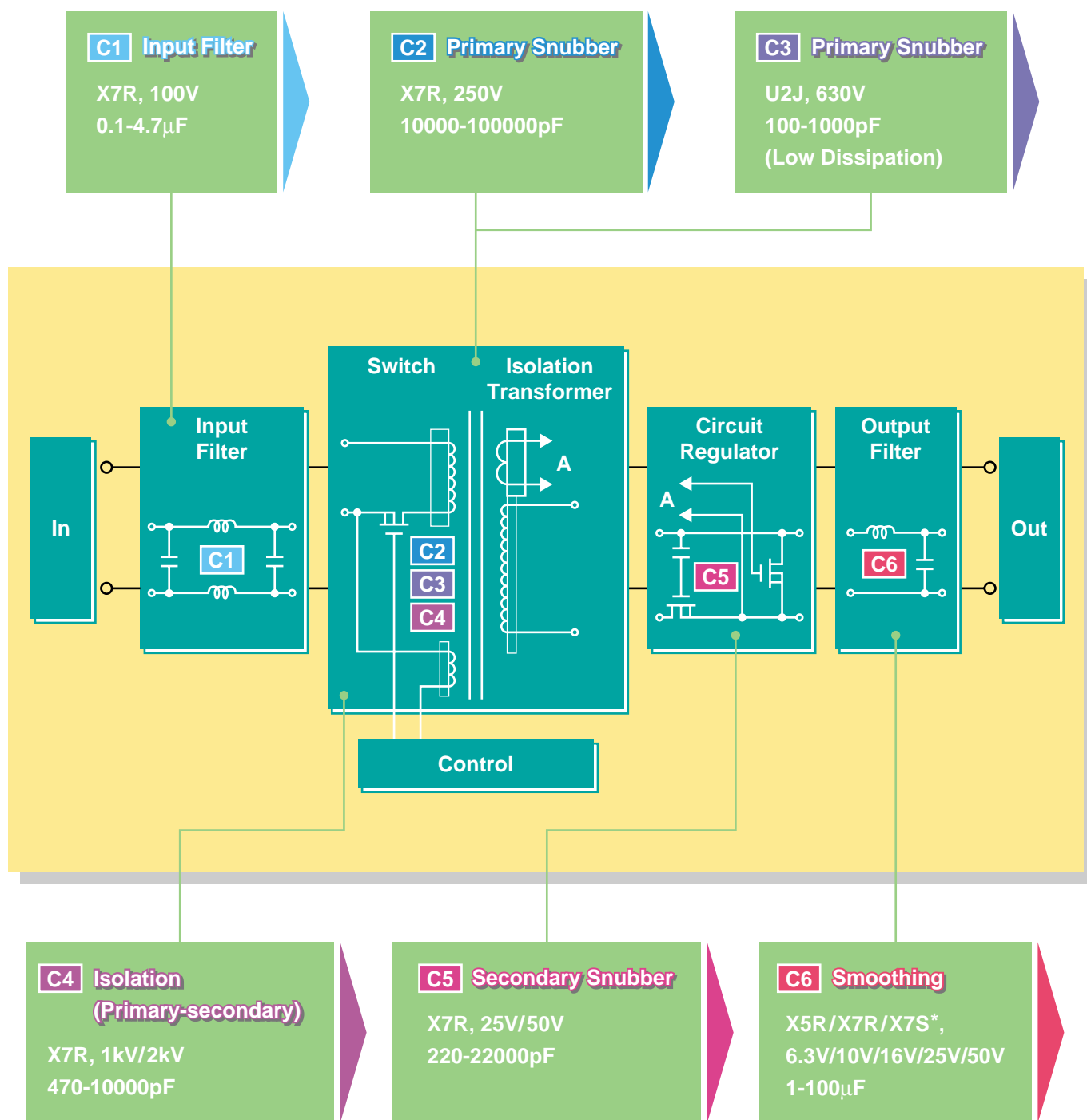

$\Delta$ Note • This catalog has only typical specifications because there is no space for detailed specifications. Therefore, please approve our product specifications or transact the approval sheet for product specifications before ordering. Especially, please read rating and  $\Delta$ CAUTION (for storage, operating, rating, soldering, mounting and handling) in them to prevent smoking and/or burning, etc.  
• You are able to read a detailed specifications in the website (<http://search.murata.co.jp/>) before to require our product specifications or to transact the approval sheet for product specifications.

● Line Up

Applications		Part Number	TC Code	Rated Voltage (Vdc)	Capacitance	Length (mm)	Width (mm)	Thickness (mm)	Case Size (JIS/EIA)
C1	Input Filter	GRM188R72A104KA35D	X7R	100	0.1μF	1.6	0.8	0.8	1608/0603
		GRM319R72A104KA01D	X7R	100	0.1μF	3.2	1.6	0.85	3216/1206
		GRM31MR72A224KA01L	X7R	100	0.22μF	3.2	1.6	1.15	3216/1206
		GRM31MR72A474KA35L	X7R	100	0.47μF	3.2	1.6	1.15	3216/1206
		GRF31MR72A474KA11L	X7R	100	0.47μF	3.2	1.6	1.15	3216/1206
		GRM31CR72A105KA01L	X7R	100	1μF	3.2	1.6	1.6	3216/1206
		GRF31CR72A105KA01L	X7R	100	1μF	3.2	1.6	1.6	3216/1206
		GRM32ER72A225KA35L	X7R	100	2.2μF	3.2	2.5	2.5	3225/1210
		GRF32ER72A225KA11L	X7R	100	2.2μF	3.2	2.5	2.5	3225/1210
GRM55ER72A475KA01L	X7R	100	4.7μF	5.7	5.0	2.5	5750/2220		
C2	Primary Snubber	GRM21BR72E103KW03L	X7R	250	10000pF	2.0	1.25	1.25	2012/0805
		GRM31BR72E153KW01L	X7R	250	15000pF	3.2	1.6	1.25	3216/1206
		GRM31BR72E223KW01L	X7R	250	22000pF	3.2	1.6	1.25	3216/1206
		GRM31CR72E333KW03L	X7R	250	33000pF	3.2	1.6	1.6	3216/1206
		GRM31CR72E473KW03L	X7R	250	47000pF	3.2	1.6	1.6	3216/1206
GRM31CR72E104KW03L	X7R	250	0.1μF	3.2	1.6	1.6	3216/1206		
C3	Primary Snubber (Low Dissipation)	GRM31A7U2J101JW31D	U2J	630	100pF	3.2	1.6	1.0	3216/1206
		GRM31A7U2J151JW31D	U2J	630	150pF	3.2	1.6	1.0	3216/1206
		GRM31A7U2J221JW31D	U2J	630	220pF	3.2	1.6	1.0	3216/1206
		GRM31A7U2J331JW31D	U2J	630	330pF	3.2	1.6	1.0	3216/1206
		GRM31A7U2J471JW31D	U2J	630	470pF	3.2	1.6	1.0	3216/1206
		GRM31A7U2J681JW31D	U2J	630	680pF	3.2	1.6	1.0	3216/1206
GRM31A7U2J102JW31D	U2J	630	1000pF	3.2	1.6	1.0	3216/1206		
C4	Isolation	GRM31BR73A471KW01L	X7R	1k	470pF	3.2	1.6	1.25	3216/1206
		GRM31BR73A511KW01L	X7R	1k	510pF	3.2	1.6	1.25	3216/1206
		GRM31BR73A102KW01L	X7R	1k	1000pF	3.2	1.6	1.25	3216/1206
		GRM31BR73A152KW01L	X7R	1k	1500pF	3.2	1.6	1.25	3216/1206
		GRM31BR73A222KW01L	X7R	1k	2200pF	3.2	1.6	1.25	3216/1206
		GRM31BR73A332KW01L	X7R	1k	3300pF	3.2	1.6	1.25	3216/1206
		GRM31BR73A472KW01L	X7R	1k	4700pF	3.2	1.6	1.25	3216/1206
		GRM32QR73A682KW01L	X7R	1k	6800pF	3.2	2.5	1.5	3225/1210
		GRM32QR73A103KW01L	X7R	1k	10000pF	3.2	2.5	1.5	3225/1210
		GR442DR73D102KW02L	X7R	2k	1000pF	4.5	2.0	2.0	4520/1808
GR443DR73D222KW01L	X7R	2k	2200pF	4.5	3.2	2.0	4532/1812		
C5	Secondary Snubber	GRM155R71E682KA01D	X7R	25	6800pF	1.0	0.5	0.5	1005/0402
		GRM155R71E103KA01D	X7R	25	10000pF	1.0	0.5	0.5	1005/0402
		GRM155R71H221KA01D	X7R	50	220pF	1.0	0.5	0.5	1005/0402
		GRM188R71H221KA01D	X7R	50	220pF	1.6	0.8	0.8	1608/0603
		GRM155R71H331KA01D	X7R	50	330pF	1.0	0.5	0.5	1005/0402
		GRM188R71H331KA01D	X7R	50	330pF	1.6	0.8	0.8	1608/0603
		GRM155R71H471KA01D	X7R	50	470pF	1.0	0.5	0.5	1005/0402
		GRM188R71H471KA01D	X7R	50	470pF	1.6	0.8	0.8	1608/0603
		GRM155R71H681KA01D	X7R	50	680pF	1.0	0.5	0.5	1005/0402
		GRM188R71H681KA01D	X7R	50	680pF	1.6	0.8	0.8	1608/0603
		GRM155R71H102KA01D	X7R	50	1000pF	1.0	0.5	0.5	1005/0402
		GRM188R71H102KA01D	X7R	50	1000pF	1.6	0.8	0.8	1608/0603
		GRM155R71H152KA01D	X7R	50	1500pF	1.0	0.5	0.5	1005/0402
		GRM188R71H152KA01D	X7R	50	1500pF	1.6	0.8	0.8	1608/0603
		GRM155R71H222KA01D	X7R	50	2200pF	1.0	0.5	0.5	1005/0402
		GRM188R71H222KA01D	X7R	50	2200pF	1.6	0.8	0.8	1608/0603
		GRM155R71H332KA01D	X7R	50	3300pF	1.0	0.5	0.5	1005/0402
GRM188R71H332KA01D	X7R	50	3300pF	1.6	0.8	0.8	1608/0603		
GRM155R71H472KA01D	X7R	50	4700pF	1.0	0.5	0.5	1005/0402		

Continued on the following page. ↗

△Note • This catalog has only typical specifications because there is no space for detailed specifications. Therefore, please approve our product specifications or transact the approval sheet for product specifications before ordering. Especially, please read rating and △CAUTION (for storage, operating, rating, soldering, mounting and handling) in them to prevent smoking and/or burning, etc.  
 • You are able to read a detailed specifications in the website (<http://search.murata.co.jp/>) before to require our product specifications or to transact the approval sheet for product specifications.

 Continued from the preceding page.

Applications		Part Number	TC Code	Rated Voltage (Vdc)	Capacitance	Length (mm)	Width (mm)	Thickness (mm)	Case Size (JIS/EIA)
C5	Secondary Snubber	GRM188R71H472KA01D	X7R	50	4700pF	1.6	0.8	0.8	1608/0603
		GRM188R71H682KA01D	X7R	50	6800pF	1.6	0.8	0.8	1608/0603
		GRM188R71H103KA01D	X7R	50	10000pF	1.6	0.8	0.8	1608/0603
		GRM188R71H153KA01D	X7R	50	15000pF	1.6	0.8	0.8	1608/0603
		GRM188R71H223KA01D	X7R	50	22000pF	1.6	0.8	0.8	1608/0603
C6	Smoothing	GRM155R60J105KE19D	X5R	6.3	1μF	1.0	0.5	0.5	1005/0402
		GRM188R60J105KA01D	X5R	6.3	1μF	1.6	0.8	0.8	1608/0603
		GRM188R60J225KE19D	X5R	6.3	2.2μF	1.6	0.8	0.8	1608/0603
		GRM21BR70J225KA01L	X7R	6.3	2.2μF	2.0	1.25	1.25	2012/0805
		GRM188R60J475KE19D	X5R	6.3	4.7μF	1.6	0.8	0.8	1608/0603
		GRM219R60J475KE01D	X5R	6.3	4.7μF	2.0	1.25	0.85	2012/0805
		GRM219R60J106KE19D	X5R	6.3	10μF	2.0	1.25	0.85	2012/0805
		GRM21BR60J106KE19L	X5R	6.3	10μF	2.0	1.25	1.25	2012/0805
		GRM21BR60J226ME39L	X5R	6.3	22μF	2.0	1.25	1.25	2012/0805
		GRM31CR60J226KE19L	X5R	6.3	22μF	3.2	1.6	1.6	3216/1206
		GRM31CR60J476ME19L	X5R	6.3	47μF	3.2	1.6	1.6	3216/1206
		GRM43ER60J476KE01L	X5R	6.3	47μF	4.5	3.2	2.5	4532/1812
		GRM32ER60J107ME20L	X5R	6.3	100μF	3.2	2.5	2.5	3225/1210
		GRM21BR71A105KA01L	X7R	10	1μF	2.0	1.25	1.25	2012/0805
		GRM188C71A105KA12D	X7S	10	1μF	1.6	0.8	0.8	1608/0603
		GRM188R61A225KE34D	X5R	10	2.2μF	1.6	0.8	0.8	1608/0603
		GRM21BR71A225KA01L	X7R	10	2.2μF	2.0	1.25	1.25	2012/0805
		GRM219R61A475KE34D	X5R	10	4.7μF	2.0	1.25	0.85	2012/0805
		GRM21BC71A475KA73L	X7S	10	4.7μF	2.0	1.25	1.25	2012/0805
		GRM21BR61A106KE19L	X5R	10	10μF	2.0	1.25	1.25	2012/0805
		GRM319R61A106KE19D	X5R	10	10μF	3.2	1.6	0.85	3216/1206
		GRM31CR71A106KA01L	X7R	10	10μF	3.2	1.6	1.6	3216/1206
		GRM32ER71A226KE20L	X7R	10	22μF	3.2	2.5	2.5	3225/1210
		GRM43ER61A476KE19L	X5R	10	47μF	4.5	3.2	2.5	4532/1812
		GRM188R61C105KA93D	X5R	16	1μF	1.6	0.8	0.8	1608/0603
		GRM188R71C105KA12D	X7R	16	1μF	1.6	0.8	0.8	1608/0603
		GRM21BR71C105KA01L	X7R	16	1μF	2.0	1.25	1.25	2012/0805
		GRM219R61C225KA88D	X5R	16	2.2μF	2.0	1.25	0.85	2012/0805
		GRM21BR61C225KA88L	X5R	16	2.2μF	2.0	1.25	1.25	2012/0805
		GRM31MR71C225KA35L	X7R	16	2.2μF	3.2	1.6	1.15	3216/1206
		GRM21BR61C475KA88L	X5R	16	4.7μF	2.0	1.25	1.25	2012/0805
		GRM319R61C475KA88D	X5R	16	4.7μF	3.2	1.6	0.85	3216/1206
		GRM31CR61C475KA01L	X5R	16	4.7μF	3.2	1.6	1.6	3216/1206
		GRM31CR71C475KA01L	X7R	16	4.7μF	3.2	1.6	1.6	3216/1206
		GRM32DR61C106KA01L	X5R	16	10μF	3.2	2.5	2.0	3225/1210
		GRM32DR71C106KA01L	X7R	16	10μF	3.2	2.5	2.0	3225/1210
		GRM32ER61C226KE20L	X5R	16	22μF	3.2	2.5	2.5	3225/1210
		GRM188R61E105KA12D	X5R	25	1μF	1.6	0.8	0.8	1608/0603
		GRM216R61E105KA12D	X5R	25	1μF	2.0	1.25	0.6	2012/0805
		GRM21BR71E105KA99L	X7R	25	1μF	2.0	1.25	1.25	2012/0805
GRM219R61E225KA12D	X5R	25	2.2μF	2.0	1.25	0.85	2012/0805		
GRM21BR61E225KA12L	X5R	25	2.2μF	2.0	1.25	1.25	2012/0805		
GRM31MR71E225KA93L	X7R	25	2.2μF	3.2	1.6	1.15	3216/1206		
GRM21BR61E475KA12L	X5R	25	4.7μF	2.0	1.25	1.25	2012/0805		
GRM319R61E475KA12D	X5R	25	4.7μF	3.2	1.6	0.85	3216/1206		
GRM31CR71E475KA88L	X7R	25	4.7μF	3.2	1.6	1.6	3216/1206		
GRM31CR61E106KA12L	X5R	25	10μF	3.2	1.6	1.6	3216/1206		
GRM32DR61E106KA12L	X5R	25	10μF	3.2	2.5	2.0	3225/1210		

Continued on the following page. 

△Note • This catalog has only typical specifications because there is no space for detailed specifications. Therefore, please approve our product specifications or transact the approval sheet for product specifications before ordering. Especially, please read rating and △CAUTION (for storage, operating, rating, soldering, mounting and handling) in them to prevent smoking and/or burning, etc.  
• You are able to read a detailed specifications in the website (<http://search.murata.co.jp/>) before to require our product specifications or to transact the approval sheet for product specifications.

 Continued from the preceding page.

Applications		Part Number	TC Code	Rated Voltage (Vdc)	Capacitance	Length (mm)	Width (mm)	Thickness (mm)	Case Size (JIS/EIA)
C6	Smoothing	GRM32DR71E106KA12L	X7R	25	10 $\mu$ F	3.2	2.5	2.0	3225/1210
		GRM31MR71H105KA87L	X7R	50	1 $\mu$ F	3.2	1.6	1.15	3216/1206
		GRM31CR71H225KA88L	X7R	50	2.2 $\mu$ F	3.2	1.6	1.6	3216/1206
		GRM32ER71H475KA88L	X7R	50	4.7 $\mu$ F	3.2	2.5	2.5	3225/1210
		GRM55DR61H106KA88L	X5R	50	10 $\mu$ F	5.7	5.0	2.0	5750/2220

$\Delta$ Note • This catalog has only typical specifications because there is no space for detailed specifications. Therefore, please approve our product specifications or transact the approval sheet for product specifications before ordering. Especially, please read rating and  $\Delta$ CAUTION (for storage, operating, rating, soldering, mounting and handling) in them to prevent smoking and/or burning, etc.  
 • You are able to read a detailed specifications in the website (<http://search.murata.co.jp/>) before to require our product specifications or to transact the approval sheet for product specifications.

## VRM (Voltage Regulator Module)

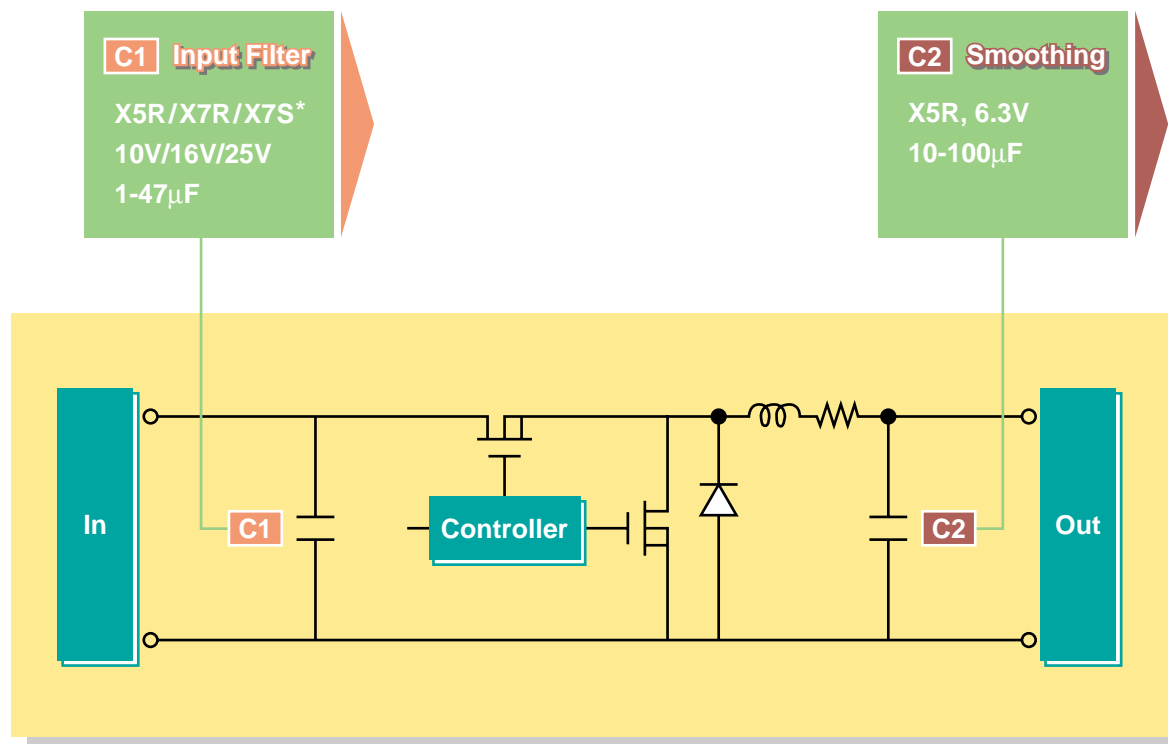

\*X7S: -55 to 125°C (Temperature range), ±22% (Capacitance change)

## ● Line Up

Applications	Part Number	TC Code	Rated Voltage (Vdc)	Capacitance (μF)	Length (mm)	Width (mm)	Thickness (mm)	Case Size (JIS/EIA)	
C1	Input Filter	GRM188R61A105KA61D	X5R	10	1	1.6	0.8	0.8	1608/0603
		GRM21BR71A105KA01L	X7R	10	1	2.0	1.25	1.25	2012/0805
		GRM188C71A105KA12D	X7S	10	1	1.6	0.8	0.8	1608/0603
		GRM188R61A225KE34D	X5R	10	2.2	1.6	0.8	0.8	1608/0603
		GRM21BR71A225KA01L	X7R	10	2.2	2.0	1.25	1.25	2012/0805
		GRM219R61A475KE34D	X5R	10	4.7	2.0	1.25	0.85	2012/0805
		GRM21BC71A475KA73L	X7S	10	4.7	2.0	1.25	1.25	2012/0805
		GRM21BR61A106KE19L	X5R	10	10	2.0	1.25	1.25	2012/0805
		GRM319R61A106KE19D	X5R	10	10	3.2	1.6	0.85	3216/1206
		GRM31CR71A106KA01L	X7R	10	10	3.2	1.6	1.6	3216/1206
		GRM32ER71A226KE20L	X7R	10	22	3.2	2.5	2.5	3225/1210
		GRM43ER61A476KE19L	X5R	10	47	4.5	3.2	2.5	4532/1812
		GRM188R61C105KA93D	X5R	16	1	1.6	0.8	0.8	1608/0603
		GRM188R71C105KA12D	X7R	16	1	1.6	0.8	0.8	1608/0603
		GRM21BR71C105KA01L	X7R	16	1	2.0	1.25	1.25	2012/0805
		GRM219R61C225KA88D	X5R	16	2.2	2.0	1.25	0.85	2012/0805
		GRM21BR61C225KA88L	X5R	16	2.2	2.0	1.25	1.25	2012/0805
		GRM31MR71C225KA35L	X7R	16	2.2	3.2	1.6	1.15	3216/1206
		GRM21BR61C475KA88L	X5R	16	4.7	2.0	1.25	1.25	2012/0805
		GRM319R61C475KA88D	X5R	16	4.7	3.2	1.6	0.85	3216/1206
		GRM31CR61C475KA01L	X5R	16	4.7	3.2	1.6	1.6	3216/1206
		GRM31CR71C475KA01L	X7R	16	4.7	3.2	1.6	1.6	3216/1206
		GRM32DR61C106KA01L	X5R	16	10	3.2	2.5	2.0	3225/1210
		GRM32DR71C106KA01L	X7R	16	10	3.2	2.5	2.0	3225/1210

Continued on the following page.

△Note • This catalog has only typical specifications because there is no space for detailed specifications. Therefore, please approve our product specifications or transact the approval sheet for product specifications before ordering. Especially, please read rating and △CAUTION (for storage, operating, rating, soldering, mounting and handling) in them to prevent smoking and/or burning, etc.

• You are able to read a detailed specifications in the website (<http://search.murata.co.jp/>) before to require our product specifications or to transact the approval sheet for product specifications.

 Continued from the preceding page.

Applications		Part Number	TC Code	Rated Voltage (Vdc)	Capacitance (μF)	Length (mm)	Width (mm)	Thickness (mm)	Case Size (JIS/EIA)
C1	Input Filter	GRM32ER61C226KE20L	X5R	16	22	3.2	2.5	2.5	3225/1210
		GRM188R61E105KA12D	X5R	25	1	1.6	0.8	0.8	1608/0603
		GRM216R61E105KA12D	X5R	25	1	2.0	1.25	0.6	2012/0805
		GRM21BR71E105KA99L	X7R	25	1	2.0	1.25	1.25	2012/0805
		GRM219R61E225KA12D	X5R	25	2.2	2.0	1.25	0.85	2012/0805
		GRM21BR61E225KA12L	X5R	25	2.2	2.0	1.25	1.25	2012/0805
		GRM31MR71E225KA93L	X7R	25	2.2	3.2	1.6	1.15	3216/1206
		GRM21BR61E475KA12L	X5R	25	4.7	2.0	1.25	1.25	2012/0805
		GRM319R61E475KA12D	X5R	25	4.7	3.2	1.6	0.85	3216/1206
		GRM31CR71E475KA88L	X7R	25	4.7	3.2	1.6	1.6	3216/1206
		GRM31CR61E106KA12L	X5R	25	10	3.2	1.6	1.6	3216/1206
GRM32DR71E106KA12L	X7R	25	10	3.2	2.5	2.0	3225/1210		
C2	Smoothing	GRM219R60J106KE19D	X5R	6.3	10	2.0	1.25	0.85	2012/0805
		GRM21BR60J106KE19L	X5R	6.3	10	2.0	1.25	1.25	2012/0805
		GRM21BR60J226ME39L	X5R	6.3	22	2.0	1.25	1.25	2012/0805
		GRM31CR60J226KE19L	X5R	6.3	22	3.2	1.6	1.6	3216/1206
		GRM31CR60J476ME19L	X5R	6.3	47	3.2	1.6	1.6	3216/1206
		GRM32ER60J107ME20L	X5R	6.3	100	3.2	2.5	2.5	3225/1210

△Note • This catalog has only typical specifications because there is no space for detailed specifications. Therefore, please approve our product specifications or transact the approval sheet for product specifications before ordering. Especially, please read rating and △CAUTION (for storage, operating, rating, soldering, mounting and handling) in them to prevent smoking and/or burning, etc.

• You are able to read a detailed specifications in the website (<http://search.murata.co.jp/>) before to require our product specifications or to transact the approval sheet for product specifications.

**⚠ Note:****1. Export Control**

〈For customers outside Japan〉

Murata products should not be used or sold for use in the development, production, stockpiling or utilization of any conventional weapons or mass-destructive weapons (nuclear weapons, chemical or biological weapons, or missiles), or any other weapons.

〈For customers in Japan〉

For products which are controlled items subject to the "Foreign Exchange and Foreign Trade Law" of Japan, the export license specified by the law is required for export.

**2. Please contact our sales representatives or product engineers before using the products in this catalog for the applications listed below, which require especially high reliability for the prevention of defects which might directly damage to a third party's life, body or property, or when one of our products is intended for use in applications other than those specified in this catalog.**

- |                             |   |
|-----------------------------|---|
| ① Aircraft equipment        | ② Aerospace equipment   |
| ③ Undersea equipment        | ④ Power plant equipment   |
| ⑤ Medical equipment         | ⑥ Transportation equipment (vehicles, trains, ships, etc.)  |
| ⑦ Traffic signal equipment  | ⑧ Disaster prevention / crime prevention equipment  |
| ⑨ Data-processing equipment | ⑩ Application of similar complexity and/or reliability requirements to the applications listed in the above |

**3. Product specifications in this catalog are as of March 2004. They are subject to change or our products in it may be discontinued without advance notice. Please check with our sales representatives or product engineers before ordering. If there are any questions, please contact our sales representatives or product engineers.**

**4. Please read rating and ⚠CAUTION (for storage, operating, rating, soldering, mounting and handling) in this catalog to prevent smoking and/or burning, etc.**

**5. This catalog has only typical specifications because there is no space for detailed specifications. Therefore, please approve our product specifications or transact the approval sheet for product specifications before ordering.**

**6. Please note that unless otherwise specified, we shall assume no responsibility whatsoever for any conflict or dispute that may occur in connection with the effect of our and/or a third party's intellectual property rights and other related rights in consideration of your use of our products and/or information described or contained in our catalogs. In this connection, no representation shall be made to the effect that any third parties are authorized to use the rights mentioned above under licenses without our consent.**

**7. No ozone depleting substances (ODS) under the Montreal Protocol are used in our manufacturing process.**