

Capacitors Catalog

For Automotive

A changing world of vehicle with innovative Rubycon Design

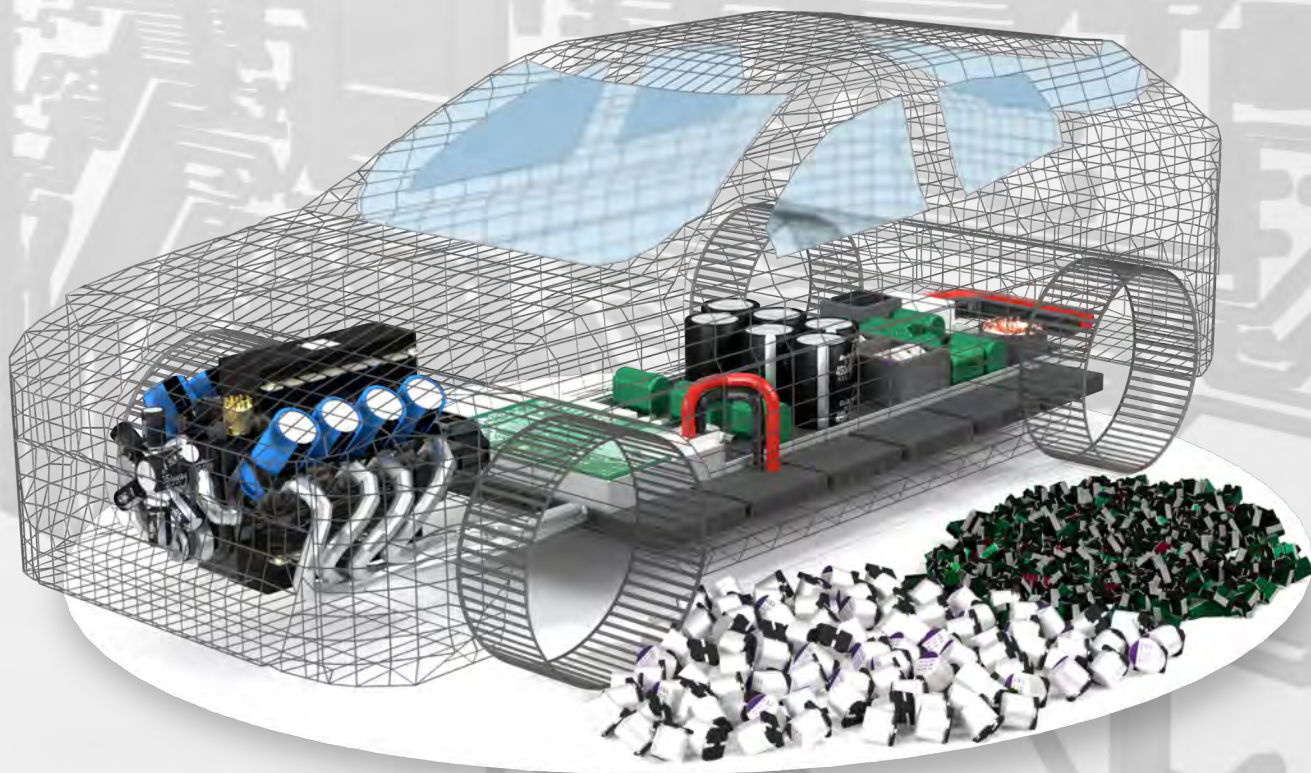

DRIVE CONTROL

Electric EGR (Exhaust Gas Recirculation)

EFI (Electric Fuel Injection)

Electric Water Pump

Engine Cooling Fan

Engine ECU

Transmission

PZ-CAP

TSV
TGV

RXA
RXL

HRX
HGX
RXG

PML

CRUISE

ABS (Anti-Lock Brake System)

EPS (Electric Power Steering)

ESC (Electric Stability Control)

PZ-CAP

THV
TGV

HRX
HGX

SAFETY

AFS (Adapted Front-Light System)

Collision Safety ECU

AIRBAG

TPMS (Tire Pressure Monitoring System)

ADAS (Advanced Driver-Assistance Systems)

PZ-CAP

THV
TGV

PML

YXJ

PZ-CAP

TAV

BODY CONTROL

HID/LED Head Light Driver

Junction Box/BCM (Body Control Module)

Smart Key System

Electric Mirror

CCH (Climate Control Head)

Power Slide Door

Power Window

Wiper

PZ-CAP

TZV
TLV

PML

TNV
TPV

JXF
YXJ

INFOTAINMENT

MFD (Multi Function Display)

Car Audio

Car Navigation

Power Amplifier

Drive Recorder/Digital Recorder

PZ-CAP

TPV
TNV

PML

THV
TGV

HEV/EV APPLICATION

Driving motor

e-4WD

ISG (Intelligent Starter Generator)

BMS (Battery Management System)

Electric Compressor for Air-conditioner

Idling System Back-Up

AC Inverter

On-Board Battery Charger

Stand type Battery Charger

Wireless Charging System

Alternator Regeneration

PZ-CAP

THV
TGV

HBX
HCX





PZ-CAP

TZV
TLV

PML

FILM

VXH
HXG
BHW

-  Conductive Polymer Aluminum Solid Capacitor
-  Aluminum Electrolytic Capacitor
-  Film Capacitor
-  Polymer Multi-Layer Capacitor

上記記載のシリーズは代表シリーズであり、車載対応品が上記シリーズのみというものではありません。
ルビコンではお客様の要求仕様に基づき、すべての商品群から最適な製品提案を行います。
AEC-Q200対応可。詳細はお問い合わせください。

Rubycon Automotive products are not limited in the series mentioned above. Series above are just flagship products use in the automotive applications.

Rubycon propose the best solution from our products based upon the customers request and regulation.
AEC-Q200. For further detail, please contact our sales office.

Feature of PZ-CAP

- 高リップル電流 High Ripple Current
- 高信頼性 High Reliability
- 超低ESR Ultra Lower ESR
- 安定した温度特性 Stable characteristics over temp.



105°C 10000Hrs



125°C 4000Hrs



125°C 4000Hrs



135°C 4000Hrs



150°C 1000Hrs



135°C 3000Hrs

- 従来品の1.5倍のリップル電流対応
1.5 times higher ripple current than conventional products
- 耐久性試験後の規格値を設定
Standard values set after endurance test

PFV series

- 125°C 4000hours
- Miniaturized
- AEC-Q200



items	Characteristics	items	Characteristics
Rated Voltage	25 ~ 80Vdc	Temperature	-55 ~ +125°C
Capacitance	10 ~ 330μF	Size(mm)	Φ6.3x6.1 ~ Φ10x10.5

Standard Size

Volt (Vdc)	Cap. (μF)	Size	ESR 100kHz		Rated RippleCurrent
			20°C	-40°C	
25	56	6.3x6.1	50		900
	100	6.3x6.8	30		1400
	220	8x10.5	27		1600
	330	10x10.5	20		2000
35	47	6.3x6.1	60		900
	68	6.3x6.8	35		1400
	150	8x10.5	27		1600
	270	10x10.5	20		2000
50	22	6.3x6.1	80		750
	33	6.3x6.8	40		1100
	68	8x10.5	30		1250
	100	10x10.5	28		1600
63	10	6.3x6.1	120		700
	22	6.3x6.8	80		900
	33	8x10.5	40		1100
	56	10x10.5	30		1400
80	22	8x10.5	45		1100
	39	10x10.5	35		1200

Size : ΦDxL max(mm)

ESR : mΩmax

Ripple Current : mA r.m.s /125°C 100kHz

PHV series

- 135°C 4000hours (φ 6.3:2000hours)
- High Ripple Current
- OverTemperatureProof 150°C 300hours (φ 6.3:150hours)
- AEC-Q200

items	Characteristics	items	Characteristics
Rated Voltage	25 ~ 63Vdc	Temperature	-55 ~ +135°C
Capacitance	33 ~ 560μF	Size(mm)	Φ6.3x6.1 ~ Φ10x16.5

Standard Size

Volt (Vdc)		Size : ΦDxL max(mm)					
		6.3x6.1	6.3x6.8	8x10.5	10x10.5	10x12.5	10x16.5
25	Cap.	56	100	220	330	470	560
	ESR	50	30	22	20	14	11
	Ripple	900	1400	1600	2000	2300	2900
35	Cap.	47	68	150	270	330	470
	ESR	60	35	22	20	14	11
	Ripple	900	1400	1600	2000	2300	2900
50	Cap.	-	-	68	100	150	180
	ESR	-	-	30	28	18	13
	Ripple	-	-	1300	1600	2100	2600
63	Cap.	-	-	33	56	68	100
	ESR	-	-	40	30	19	15
	Ripple	-	-	1200	1500	2000	2400

Capacitance : μF ESR : mΩ MAX/20°C 100kHz Ripple Current : mA r.m.s /135°C 100kHz

PJV series

- 125°C 4000hours
- High Ripple Current
- High Capacitance
- AEC-Q200

items	Characteristics	items	Characteristics
Rated Voltage	25 ~ 63Vdc	Temperature	-55 ~ +125°C
Capacitance	47 ~ 820μF	Size(mm)	Φ6.3x6.1 ~ Φ10x16.5

Standard Size

Volt (Vdc)		Size : ΦDxL max(mm)					
		6.3x6.1	6.3x6.8	8x10.5	10x10.5	10x12.5	10x16.5
25	Cap.	68	150	270	470	560	820
	ESR	50	30	25	20	14	11
	Ripple	1080	1680	1920	2800	3500	4000
35	Cap.	56	100	180	330	390	560
	ESR	50	30	25	20	14	11
	Ripple	1080	1680	1920	2800	3500	4000
50	Cap.	-	-	82	150	180	220
	ESR	-	-	30	28	18	13
	Ripple	-	-	1700	2200	3000	3600
63	Cap.	-	-	47	82	100	150
	ESR	-	-	40	30	19	15
	Ripple	-	-	1500	1900	2700	3300

Capacitance : μF ESR : mΩ MAX/20°C 100kHz Ripple Current : mA r.m.s /125°C 100kHz

◆ Temperature Characteristics

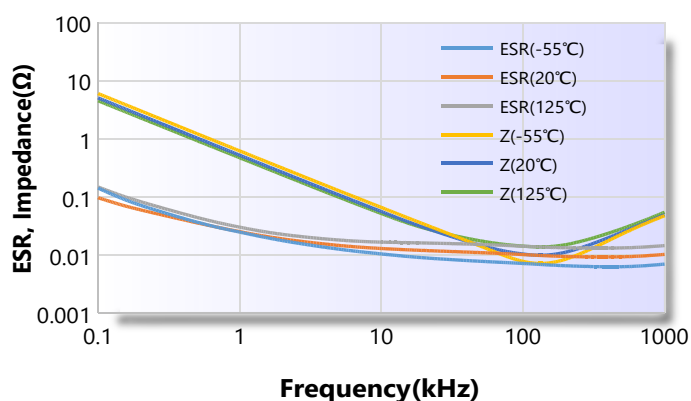
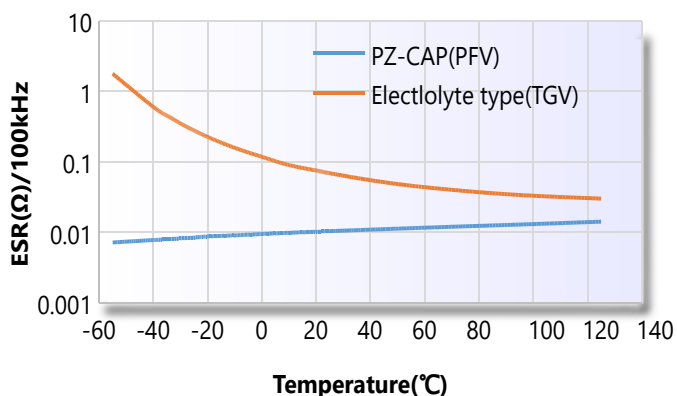

Hybrid Type is more stable than Electrolyte type across a wider temperature range.

◆ Frequency Characteristics

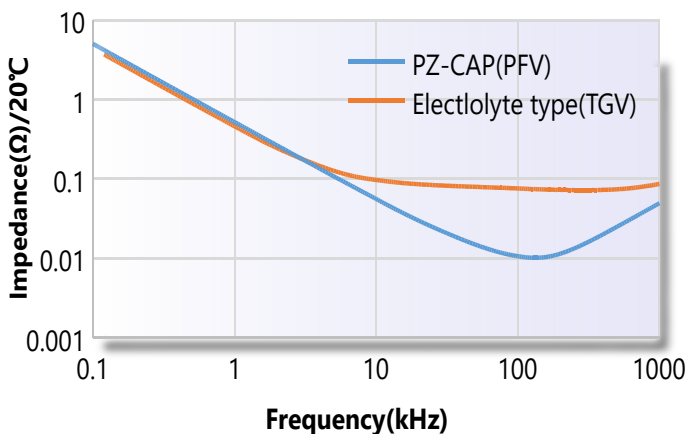
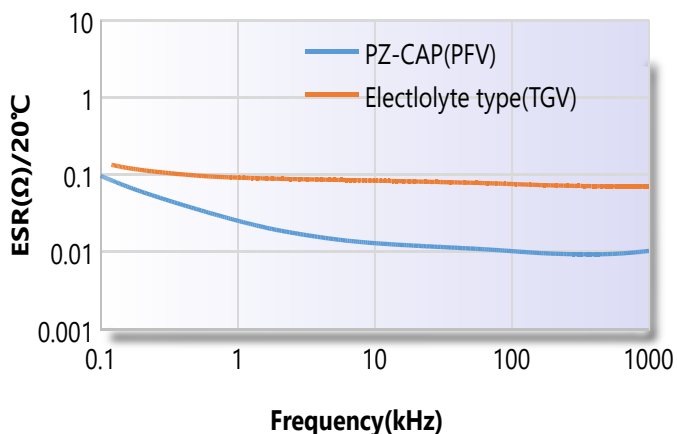

The Hybrid Type achieves lower ESR in the actual use frequency range as compared with the Electrolyte type.

◆ Lifetime Characteristics (125°C load life test)

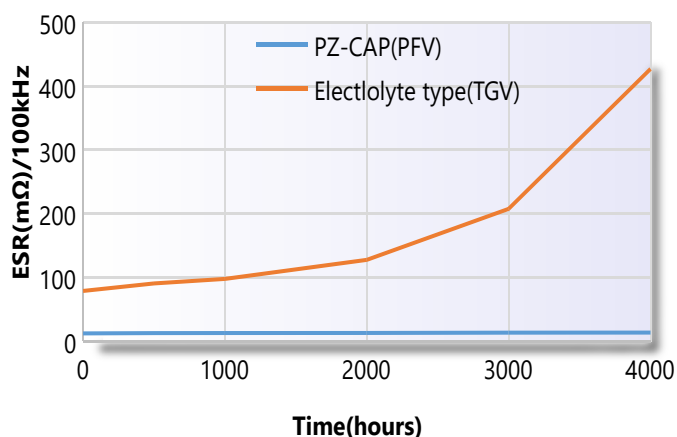
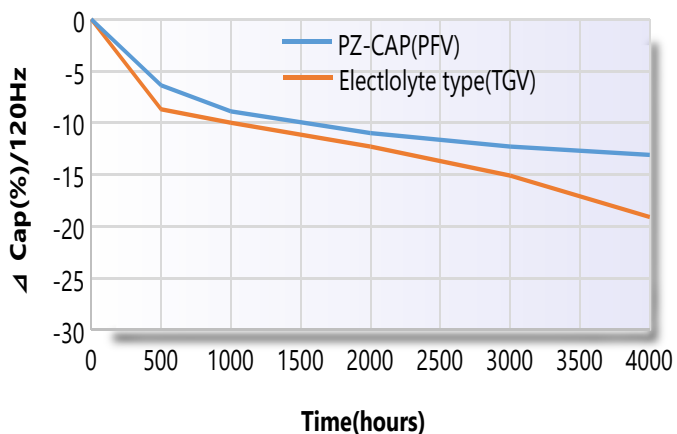

Hybrid Type has stable performance over lifetime as compared with Electrolyte type.

Comparison with electrolyte type

TGV series Electrolyte type/125°C



25v2700uF Φ 18x21.5L
 Volume:5.47cm³
 ESR:39m Ω
 Ripple:1800mArms



PJV series Hybrid type/125°C



25v270uF Φ 8x10.5L
 Volume:0.53cm³
 ESR:25m Ω
 Ripple:1920mArms

It is possible to obtain miniaturization and low ESR with the same ripple current



25v220uF Φ 8x10.5L 5pcs
 Volume:2.64cm³
 Ripple:350mArms X 5
 Total : 1750mArms



25v270uF Φ 8x10.5L
 Volume:0.53cm³
 ESR:25m Ω
 Ripple:1920mArms

It is possible to obtain cost & space saving with the same ripple current



25v330uF Φ 10x10.5L 6pcs
 Volume:4.95cm³
 ESR:120m Ω / 6
 Total : 20m Ω



25v470uF Φ 10x10.5L
 Volume:0.83cm³
 ESR:20m Ω



Cost & Space Saving !!



It is possible to obtain cost & space saving with the same ESR

Roadmap for PZ-CAP

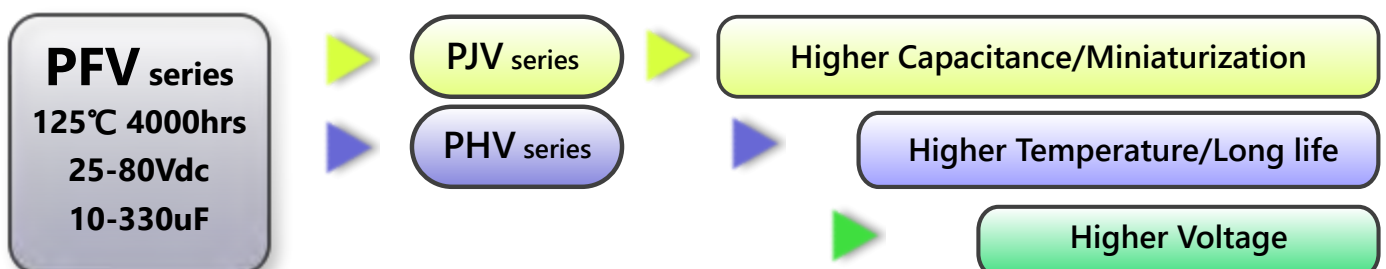



- **低圧インバータ等のDCリンク回路用途に最適**
Suitable for DC link circuit applications such as low voltage inverters
- **高リップル 小形大容量 低ESR 車載専用高信頼性**
High ripple, Small size&Large capacity, Low ESR, High reliability for automotive use



Specification

Items	Characteristics				
Temperature	-40~+135°C(Over temperature proof:+150°C)				
Rated Voltage	25~70Vdc				
Endurance	125°C又は、135°Cにおいて規定の時間定格電圧(定格リップル重畳)印加後、下記項目を満足すること。 After applying rated voltage with rated ripple current for 3000 hours(≧50Vdc(2000 hours) at each temperature, the capacitors shall meet the following requirements				
	<table border="1"> <tr> <td>125°C</td> <td>3000Hr, ≧50Vdc 2000Hr</td> </tr> <tr> <td>135°C</td> <td>3000Hr, ≧50Vdc 2000Hr</td> </tr> </table>	125°C	3000Hr, ≧50Vdc 2000Hr	135°C	3000Hr, ≧50Vdc 2000Hr
	125°C	3000Hr, ≧50Vdc 2000Hr			
	135°C	3000Hr, ≧50Vdc 2000Hr			
	Capacitance change	Within ±30% of the initial value			
Dissipation Factor	Not more than 300% of the specified value				
Leakage Current	Not more than the specified value				
Over temperature Proof	150°C500時間定格電圧印加後、下記項目を満足すること。 After applying rated voltage for 500 hours at 150°C, the capacitors shall meet the following requirements.				
	Capacitance change	Within ±30% of the initial value			
	Dissipation Factor	Not more than 300% of the specified value			
	Leakage Current	Not more than the specified value			

Rated Ripple Current comparison

135°C/35Vdc/12.5X20/100kHz

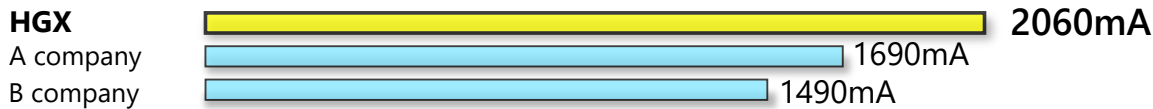

- **高圧インバータ等のDCリンク回路用途に最適**
Suitable for DC link circuit applications such as high voltage inverters
- **高リップル 低ESR 車載専用高信頼性**
High ripple current, Low ESR, High reliability for automotive use



Specification

Items	Characteristics	
Temperature	-40~+125°C	
Rated Voltage	250~290Vdc	
Endurance	125°C3000時間 定格電圧(定格リップル重畳)印加後、下記項目を満足すること。 After applying rated voltage with rated ripple current for 3000 hours at 125°C, the capacitors shall meet the following requirements	
	Capacitance change	Within ±20% of the initial value
	Dissipation Factor	Not more than 200% of the specified value
	Leakage Current	Not more than the specified value
Over temperature Proof	135°C500時間定格電圧印加後、下記項目を満足すること。	
	Capacitance change	Within ±20% of the initial value
	Dissipation Factor	Not more than 200% of the specified value
	Leakage Current	Not more than the specified value

Rated Ripple Current example

125°C/12.5X30/100kHz





- **当社従来品より約50%小形化**
About 50% smaller than conventional products
- **車載等各種ECU,小型情報通信機器用途に最適。**
Suitable for ECU such as in-vehicle and small IoT equipment applications.



Specification

Items	Characteristics																	
Temperature	-40~+125°C																	
Rated Voltage	35Vdc																	
Endurance	125°C中で2000時間定格電圧印加後、下記項目を満足すること After applying rated voltage with rated ripple current for 2000 hours at 125°C, the capacitors shall meet the following Criteria.																	
	Capacitance change	Within ±30% of the initial value																
	Dissipation Factor	Not more than 300% of the specified value																
	Leakage Current	Not more than the specified value																
Standard Size	<table border="1"> <thead> <tr> <th>Rated Volt. (Vdc)</th> <th>Cap. (μF)</th> <th>Size φD × L (mm)</th> <th>Dissipation Factor 20°C, 120Hz</th> <th>Rated Ripple Current</th> <th>E.S.R (Ω MAX./100kHz)</th> </tr> </thead> <tbody> <tr> <td rowspan="2">35</td> <td>47</td> <td>6.3×8</td> <td>0.16</td> <td>240</td> <td>0.3</td> </tr> <tr> <td>100</td> <td>6.3×8</td> <td>0.16</td> <td>240</td> <td>0.3</td> </tr> </tbody> </table>	Rated Volt. (Vdc)	Cap. (μF)	Size φD × L (mm)	Dissipation Factor 20°C, 120Hz	Rated Ripple Current	E.S.R (Ω MAX./100kHz)	35	47	6.3×8	0.16	240	0.3	100	6.3×8	0.16	240	0.3
	Rated Volt. (Vdc)	Cap. (μF)	Size φD × L (mm)	Dissipation Factor 20°C, 120Hz	Rated Ripple Current	E.S.R (Ω MAX./100kHz)												
	35	47	6.3×8	0.16	240	0.3												
100		6.3×8	0.16	240	0.3													
Rated Ripple Current (mArms/125°C, 100kHz)																		

Series comparison

Series	Rated Volt. (Vdc)	Cap. (μF)	Size φD × L (mm)	Life Time (hours)	Rated Ripple Current (mArms/125°C, 100kHz)	E.S.R (Ω 20°C/100kHz)
THV	35	47	6.3×8	2000	240	0.7
TAV		100	6.3×8	2000	240	0.3



- **150°C 1500時間保証 車載用**
150°C 1500 hours. For automotive use.
- **φ12.5X13.5L~φ18X21.5L 大径サイズ追加**
φ12.5X13.5L to φ18X21.5L large size added



Specification

Items	Characteristics						
Temperature	-40~+150°C						
Rated Voltage	25~35Vdc						
Endurance	150°C中で 表の時間定格電圧印加後、下記項目を満足すること。 After applying rated voltage for specified time at 150°C, the capacitors shall meet the following Criteria.						
	<table border="1"> <thead> <tr> <th>Case Size</th> <th>Time(hours)</th> </tr> </thead> <tbody> <tr> <td>φD ≤ 10</td> <td>1000</td> </tr> <tr> <td>φD ≥ 12.5</td> <td>1500</td> </tr> </tbody> </table>	Case Size	Time(hours)	φD ≤ 10	1000	φD ≥ 12.5	1500
	Case Size	Time(hours)					
	φD ≤ 10	1000					
	φD ≥ 12.5	1500					
Capacitance change	Within ±20% of the initial value						
Dissipation Factor	Not more than 200% of the specified value						
Leakage Current	Not more than the specified value						

Rated Ripple Current comparison

150°C/35Vdc/12.5X13.5/100kHz

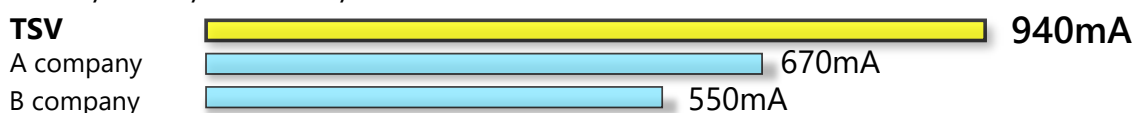



- 150°C 1500時間保証品
150°C 1500hours
- 車載機器等の高温用途に最適
Suitable for high temperature applications such as automotive equipment

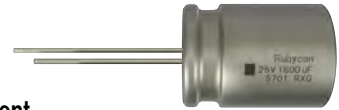

Specification

Items	Characteristics					
Temperature	-40~+150°C					
Rated Voltage	25~50Vdc					
Endurance	150°C1500 時間定格電圧印加後、下記項目を満足すること。					
	Capacitance change	Within ±30% of the initial value				
	Dissipation Factor	Not more than 300% of the specified value				
	Leakage Current	Not more than the specified value				
Standard Size Example.	Rated Ripple Current (mA rms/150°C, 100kHz)					
	Rated Volt. (Vdc)	Cap. (μF)	Size φD×L (mm)	Dissipation Factor 20°C, 120Hz	Rated Ripple Current	E.S.R (Ω 20°C/100kHz)
	25	1100	12.5×20	0.14	1150	0.07
		3600	18×25	0.14	1850	0.03
	35	1000	16×20	0.12	1520	0.045

Series comparison

Series	Rated Volt. (Vdc)	Cap. (μF)	Size φD×L (mm)	Life Time (hours)	Rated Ripple Current	E.S.R (Ω 20°C/100kHz)
RX50	25	470	12.5×20	1000	600	-
RXG		1100	12.5×20	1500	1150	0.07



- 105°C 5000時間保証品
105°C 5000hours
- 車載充電器 1次側平滑用に最適
Suitable for smoothing capacitor the primary side of on-board battery chargers.



Specification

Items	Characteristics							
Temperature	-25~+105°C							
Rated Voltage	200~500Vdc							
Standard Size Example.	Size φD×L (mm), Rated Ripple Current (Arms/105°C, 120Hz)							
	Rated Volt. (Vdc)	Cap. (μF)	Size	Ripple Current	Rated Volt. (Vdc)	Cap. (μF)	Size	Ripple Current
	200	2700	35×60	3.49	400	470	30×40	1.93
	250	1000	30×40	2.44	450	330	30×40	1.75
	350	680	30×50	2.43	500	470	35×55	2.23



- 105°C 高リップル, 低ESR品
105°C High Ripple, Low ESR
- 車載充電器 1次側平滑用に最適
Suitable for smoothing capacitor the primary side of on-board battery chargers.



Specification

Items	Characteristics							
Temperature	-25~+105°C							
Rated Voltage	160~250Vdc, 400~450Vdc							
Standard Size Example.	Size φD×L (mm), Rated Ripple Current (Arms/105°C, 120Hz)							
	Rated Volt. (Vdc)	Cap. (μF)	Size	Ripple Current	Rated Volt. (Vdc)	Cap. (μF)	Size	Ripple Current
	160	3300	35×60	7.92	400	470	30×50	3.04
	200	1000	30×35	4.24	420	220	30×30	1.85
	250	1000	35×35	4.46	450	560	35×50	3.23



- **125°C 3000~8000時間品**
125°C 3000~8000hours
- **高リップル、小形化品**
High ripple, miniaturized products

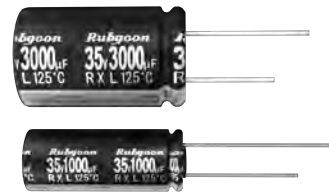

Specification

Items	Characteristics													
Temperature	-55~+125°C													
Rated Voltage	16~35Vdc													
Endurance	125°C中で表の時間定格電圧（定格リップル重畳）印加後、下記項目を満足すること。 After applying rated voltage with rated ripple current for specified time at 125°C, the capacitors shall meet the following requirement													
	<table border="1"> <thead> <tr> <th>Case Size</th> <th>Time (hours)</th> </tr> </thead> <tbody> <tr> <td>10x16</td> <td>3000</td> </tr> <tr> <td>10x20</td> <td>4000</td> </tr> <tr> <td>10x25</td> <td>5000</td> </tr> <tr> <td rowspan="2">φ D ≥ 12.5</td> <td>L ≤ 20</td> <td>6000</td> </tr> <tr> <td>L ≥ 25</td> <td>8000</td> </tr> </tbody> </table>	Case Size	Time (hours)	10x16	3000	10x20	4000	10x25	5000	φ D ≥ 12.5	L ≤ 20	6000	L ≥ 25	8000
	Case Size	Time (hours)												
	10x16	3000												
10x20	4000													
10x25	5000													
φ D ≥ 12.5	L ≤ 20	6000												
	L ≥ 25	8000												
Capacitance change	Within ±30% of the initial value													
Dissipation Factor	Not more than 300% of the specified value													
Leakage Current	Not more than the specified value													

Standard Size

Rated Ripple Current (mArms/125°C,100kHz) E.S.R (Ω MAX,100kHz)

Volt. (Vdc)	Cap. (µF)	Size φ D × L (mm)	Ripple Current	E.S.R (20°C)	E.S.R (-40°C)
16	1800	10x20	1180	0.062	0.550
25	1600	10x25	1810	0.047	0.410
25	2700	12.5x25	2280	0.030	0.210
35	3000	16x25	3030	0.025	0.100



- **105°C 10000~12000hours (-40°C対応)**
105°C 10000~12000hours (-40°C)
- **車載充電器に最適**
Suitable for in-car chargers



Specification

Items	Characteristics												
Temperature	-40~+105°C												
Rated Voltage	400~450Vdc												
Endurance	105°C中で右表の時間定格電圧（定格リップル重畳）印加後、下記項目を満足すること。 After applying rated voltage with rated ripple current for specified time at 105°C, the capacitors shall meet the following requirement												
	<table border="1"> <thead> <tr> <th>Capacitance change</th> <th>Within ±20% of the initial value</th> <th>Case Size</th> <th>Time (hrs)</th> </tr> </thead> <tbody> <tr> <td>Dissipation Factor</td> <td>Not more than 200% of the specified value</td> <td>L ≤ 20</td> <td>10000</td> </tr> <tr> <td>Leakage Current</td> <td>Not more than the specified value</td> <td>L ≥ 25</td> <td>12000</td> </tr> </tbody> </table>	Capacitance change	Within ±20% of the initial value	Case Size	Time (hrs)	Dissipation Factor	Not more than 200% of the specified value	L ≤ 20	10000	Leakage Current	Not more than the specified value	L ≥ 25	12000
	Capacitance change	Within ±20% of the initial value	Case Size	Time (hrs)									
	Dissipation Factor	Not more than 200% of the specified value	L ≤ 20	10000									
Leakage Current	Not more than the specified value	L ≥ 25	12000										
Capacitance change	Within ±20% of the initial value												
Dissipation Factor	Not more than 200% of the specified value												
Leakage Current	Not more than the specified value												

- **従来のBXWシリーズに対して最大20%小形化**
Up to 20% smaller than BXW series

Series comparison

Rated Ripple Current (mArms/105°C,120Hz)

Volt (Vdc)	Size (φ x L mm)	BHW series		BXW series	
		Cap.(µF)	Ripple Current	Cap.(µF)	Ripple Current
420	16x25	68	0.58	56	0.51
	18x40	160	1.03	150	1.00
450	16x30	82	0.67	68	0.61
	18x45	180	1.12	150	1.00

Feature of Film Capacitors

- 数100Arms (10kHz) の大電流に対応可能 Can be applied high-current application such as 100Arms
- 安定した温度特性 Stable temperature characteristics
- キロボルトオーダーの高耐電圧に対応可能 Can be applied high-voltage application such as 1kv level
- 保安機構を付加し、主故障はオープンモード Open mode failure by safety design deposition technology.
- 形状の自由度が高く、要求に合わせる事が可能 Flexible custom design based on customer's requirement
- パワー半導体への直接取付が可能 Direct connection to power semiconductor device
- 抵抗を内蔵するなどの複合モジュール化が可能 Module type available (i.e. Resister built-in)

Custom designs

カスタム仕様で端子の位置や大電流・低ESLなどの様々な要求に応えます。

Custom specifications meet various requirements such as terminal positions, large current, and Low ESL.

蒸着技術

Vapor deposition

- 小型化の為の蒸着加工技術
Vapor deposition technology for miniaturization
- 保安機構付き
Safty Function

低ESR接続技術

Low ESR connection

- 低ESR化電極
Low ESR electrode

巻き取り技術

Winding

- 薄膜フィルム巻取技術
Thin film winding

低ESLバスバー設計技術

Low ESL busbar

- 電磁解析による低ESL化
Low ESL using electromagnetic field analysis

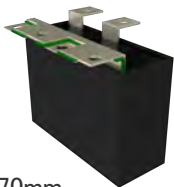

98x38x70mm
400V-200 μ F (28mm Pitch)
Actual Value: 4.1nH
(Simulation: 2.5nH)

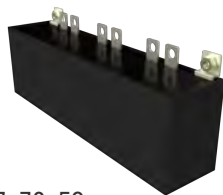

237x72x50mm
450V-500 μ F (21mm Pitch)
Actual Value: 7.7nH
(Simulation: 7.9nH)



140x50x55mm
450V-300 μ F (28mm Pitch)
Actual Value: 9.8nH
(Simulation: 10.8nH)



HVC + MPC
HVC : Smoothing
MPC : Snubber

HVC



- HEV/EV用インバータ用平滑コンデンサ
Smoothing capacitor for HEV / EV inverter
- 小型化,低ESR,低ESL化を実現
Miniaturization, low ESR, low ESL

items	Characteristics
Rated Voltage	100~4000Vdc
Capacitance	1~3000 μ F
Temperature	-40~+105 $^{\circ}$ C
Permissible current	10~250Arms@10kHz

MPC



- 電源入力フィルター用、スナバ用コンデンサ
For Power Line Filters, for snubber circuit
- 取り付け簡単構造
Easy-to-implement structure
- AC対応可
Support with AC

items	Characteristics
Rated Voltage	700~1600Vdc
Capacitance	0.1~100 μ F
Temperature	-55~+105 $^{\circ}$ C
Permissible current	10~60Arms

Suitable for Automotive application

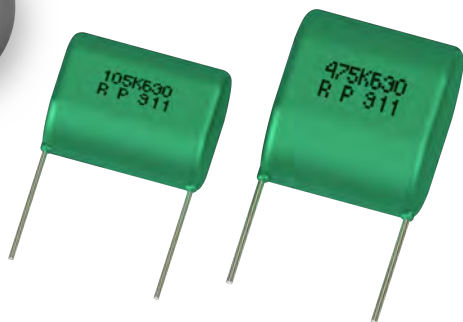

METALIZED POLYPROPYLENE FILM CAPACITORS

- カテゴリ上限温度 125°C
Upper Category Temperature
- 定格電圧 630Vdc@125°C
Rated Voltage
- 保安機構付
Safety Function
- 車載機器用途 AEC-Q200 準拠
For Automotive Application Compliant with AEC-Q200

items	Characteristics
Rated Voltage	630Vdc@125°C
Capacitance	1 ~ 6.8μF
Temperature	-40 ~ +125°C

Standard Size.

Rated Voltage (Vdc)	Cap. (μF)	Size (mm)					Parts No
		W	T	H	P	φd	
630	1	25.5	10.5	17.0	22.5	1.0	630MPT105J
	1.5	25.5	12.5	21.0	22.5	1.0	630MPT155J
	2.2	25.5	14.0	24.0	22.5	1.0	630MPT225J
	3.3	25.5	17.5	27.5	22.5	1.0	630MPT335J
	4.7	25.5	21.0	30.5	22.5	1.0	630MPT475J
	6.8	25.5	25.0	34.0	22.5	1.0	630MPT685J

Comparison other series

Rated Voltage (Vdc)	Cap. (μF)	Volume(mm ³)		
		MPT _{series}	MPK _{series}	PCK _{series}
630	1	4,552	4,335	6,408
	2.2	7,625	7,625	11,088
	4.7	15,530	-	18,928

Load Life / Capacitance T=125°C LoadVoltage=630Vdc

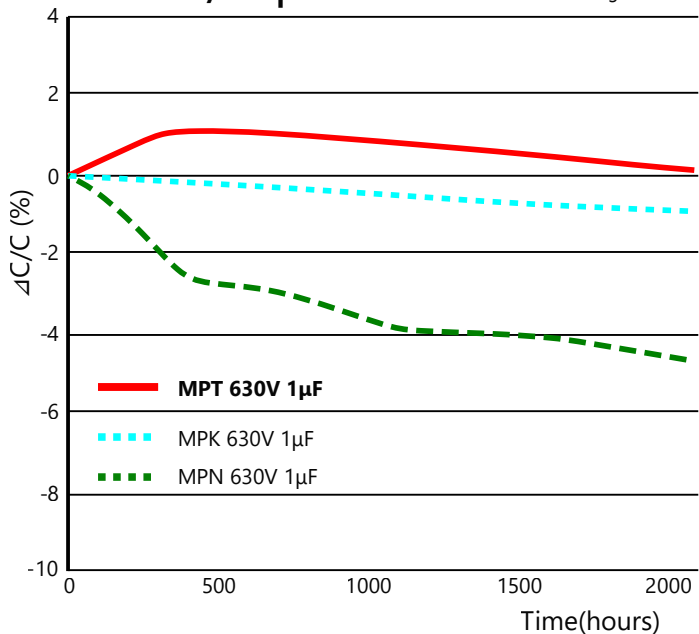

Permissible Current

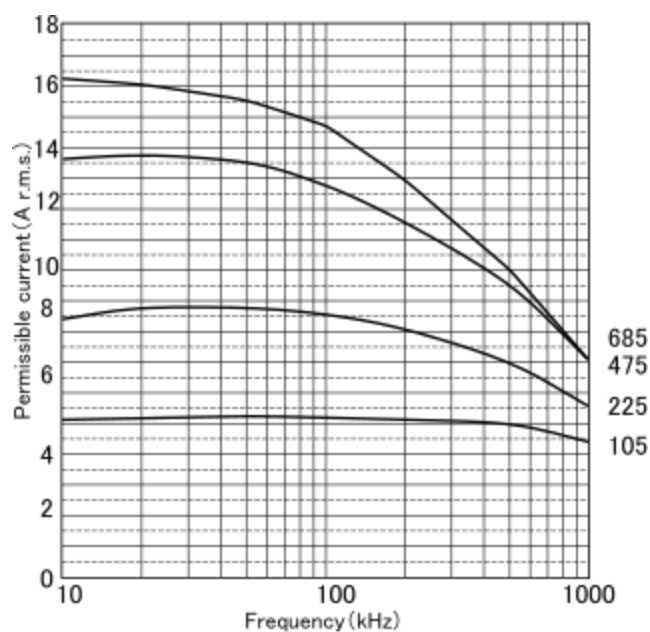

Feature of PMLCAP

フィルムコンデンサは一般的に電気的特性に優れますが、製品の小型化や高耐熱化に対して多くの課題があります。PMLCAPは真空蒸着法で誘電体を形成することにより、従来のフィルムコンデンサに比べ大幅な小型大容量化と高耐熱化を実現したポリマー(高分子)コンデンサです。

高性能・高密度実装の求められる電子機器に最適な部品です。

Film capacitors are generally excellent in electrical characteristics, but there are many challenges to the miniaturization of products and the improvement of heat resistance. PMLCAP is a polymer capacitor that realizes significantly smaller size and larger capacity and higher heat resistance than conventional film capacitors by forming a dielectric by vacuum evaporation method.

It is the optimum part for electronic equipment where high performance / high density mounting is required.

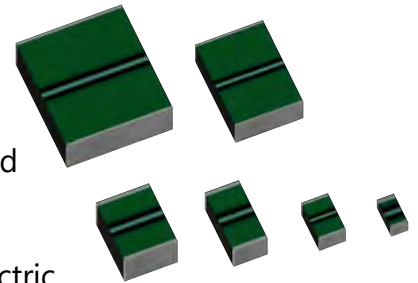

- 無外装構造のため、小型・軽量

Compact and lightweight due to non-exterior structure

- フィルム系チップ製品の中では業界最小形状の1608サイズをラインアップ

The 1608 size, the smallest among film-based chip products, is available.

- 幅広い温度範囲(-55~125℃)で安定した性能を発揮

Stable performance over a wide temperature range (-55 to 125℃)

- 一般的なフィルムコンデンサより耐熱性に優れているため、フロー/リフロー実装(鉛フリー)に対応可能

Excellent heat resistance compared to standard film capacitors, making it suitable for flow/reflow mounting (lead-free)

- 構成材料に磁性体を使用していないため、原音に忠実な音声信号処理が可能

No magnetic material is used in the component materials, enabling audio signal processing with high fidelity to the original sound.

- 振動による圧電効果が生じないため、振動環境化においても性能が安定であるとともに、ノイズの発生源にならない

No piezoelectric effect due to vibration, so performance is stable even in a vibration environment and does not become a source of noise.

Structure

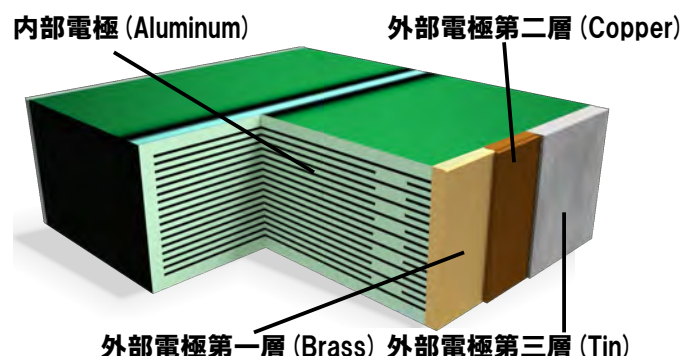
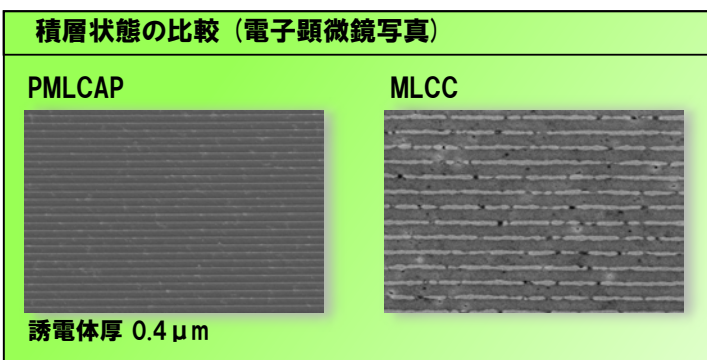

Advantage of basic performance

●PMLCAPの自己修復性と信頼性 High safety and self-healing

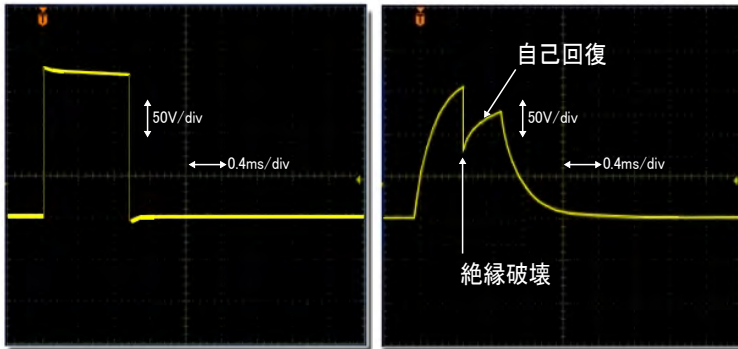

印加パルス波形

印加時のコンデンサ両端の波形

高い安全性・自己回復性 High safety and self-healing

過電圧パルスが印加されて短絡的故障が発生しても、短絡部分に電流が集中して発熱し、誘電体および蒸着金属が飛散して絶縁が回復します。

左図は強制的な短絡的故障を発生させた際の自己回復性を観察したものです。

Even if an overvoltage pulse is applied and a short-circuit failure occurs,

The current concentrates in the short circuit area and generates heat, and the dielectric and vaporized metal scatter and the insulation is restored. The figure on the left is an observation of self-healing when a forced short-circuit failure occurs.

●実装信頼性比較 (基盤屈曲) PMLCAP vs MLCC Stress due to distortion and bending of PCB

PMLCAPは、基板実装後の歪み・屈曲に対する応力に対して、積層セラミックコンデンサより優れています。

PMLCAP is superior to MLCC in terms of stress against distortion and bending after board mounting.

PMLCAP (Size 3216) N=5pcs

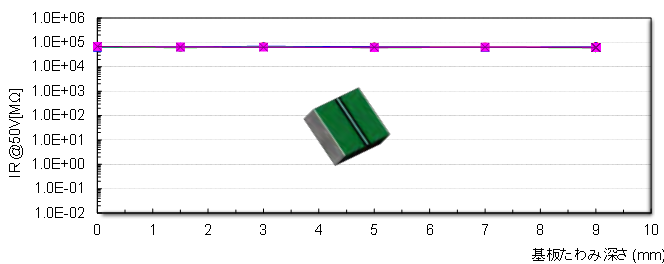

MLCC (Size 3216) N=5pcs

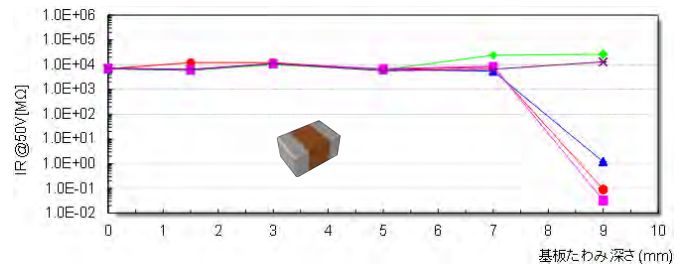

●振動によるノイズの発生 Generation of noise due to vibration

100倍に信号を増幅するアンプで、コンデンサ実装基板を叩いてPMLCAPとMLCCの発生ノイズ差異を測定

Measure the noise difference between PML CAP and MLCC by amplifying the signal by 100 times by tapping the capacitor mounting board.

測定回路 Circuit of Measurement

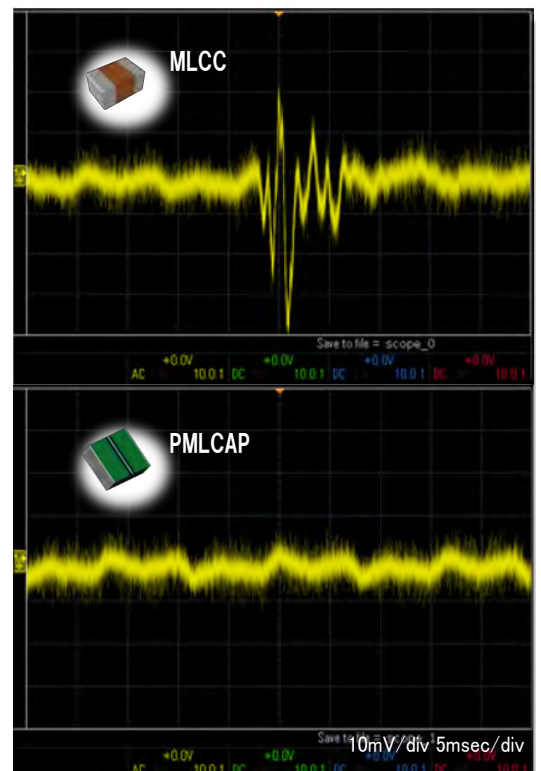
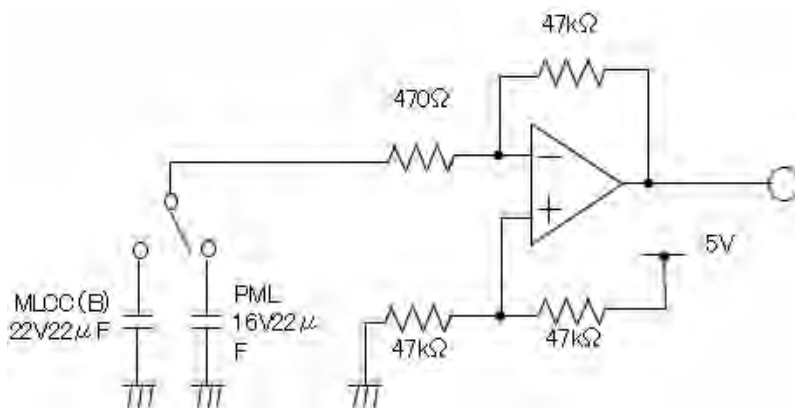

●直流バイアス特性比較 DC BIAS

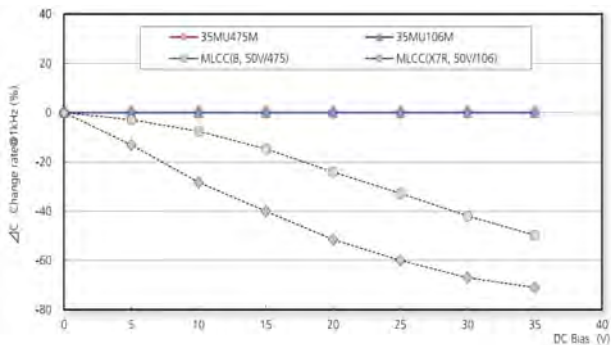

バスコンやカップリングコンデンサとして使用する際にバイアスによる容量変化がありません。機器設計時にバイアスによる容量減少分を考慮する必要がないため、高誘電率系セラミックコンデンサに対して優位です

When used as a bypass or coupling capacitor, there is no change in capacitance due to bias. Since there is no need to consider the capacitance decrease due to bias when designing equipment, it is superior to high dielectric constant ceramic capacitors.

●温度特性比較 Temperature Characteristics

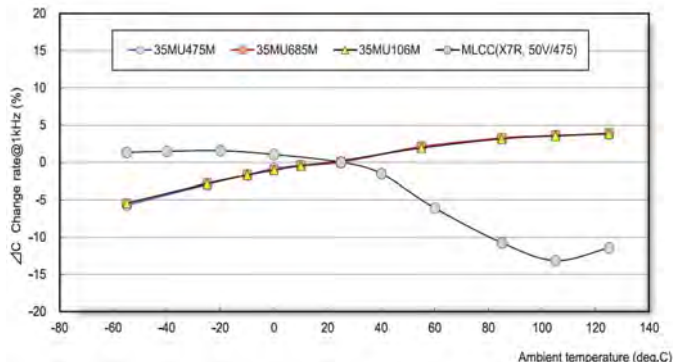

周囲温度の変化に対して、±5%と安定した温度特性を有します。また特性変化は温度上昇に対してプラスの変動(正特性)であり、周囲の温度環境に左右されない安定した回路動作へ寄与します。

Stable temperature characteristics of ±5% with respect to changes in ambient temperature. The characteristics change positively with temperature rise (positive characteristics), contributing to stable circuit operation that is not affected by the ambient temperature environment.

Feature of HV(High Voltage) PMLCAP

HV PMLCAPは従来のPMLCAPの特長を兼ね備えながら、高耐圧化を実現したポリマー(高分子)コンデンサです。高性能・高密度実装の求められる高圧回路に最適な部品です。

HV PMLCAP is a polymer capacitor that achieves high withstand voltage while having the features of conventional PMLCAP.

It is the optimum part for high voltage circuit where high performance / high density mounting is required.

items	Characteristics
Temperature	-55 ~ +125°C
Voltage , Cap.	250Vdc 1.0μF / 500Vdc 0.22μF

●ヘビーエッジ構造の導入による高電位傾度化のため、高耐圧・小型・軽量

With the introduction of the heavy edge structure, the potential gradient has been increased, resulting in high withstand voltage, small size, and light weight.

●ヘビーエッジ構造と外部電極構成の最適化により、耐電流性能を大幅に向上

The withstand current performance is greatly improved due to optimizing the heavy edge structure and external electrode configuration.

●内部直列構造の採用により、ESR・ショートリスクを低減

ESR / short risk is reduced by adopting an internal series structure.

●耐パルス性能評価(dV/dt試験) Pulse resistance performance evaluation(dV/dt test)

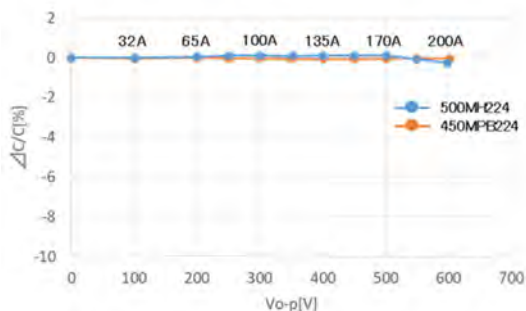

充放電試験機を用い、各電圧毎に10,000回の繰り返しパルスを印加した後の容量変化を測定しました。大電流用フィルムコンデンサに近い耐電流性能を有しています。

スナバ回路などの大電流用途へ適用可能です。

The capacitance change after applying 10,000 repeated pulses for each voltage was measured with a charge / discharge tester.

It has a withstand current performance close to that of a film capacitor for large currents.

It can be applied to high current applications such as snubber circuits.

●フィルムコンデンサとのサイズ比較(当社比)
Size comparison PMLCAP vs Film capacitor

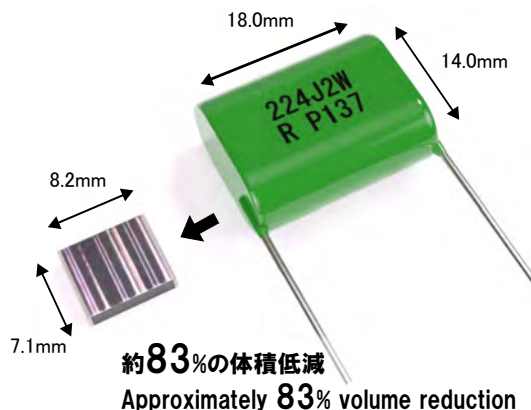

1. Quality Required for Automotive Grade Capacitor ZERO DEFECTS!

2. Design Process Chart and Necessary Information

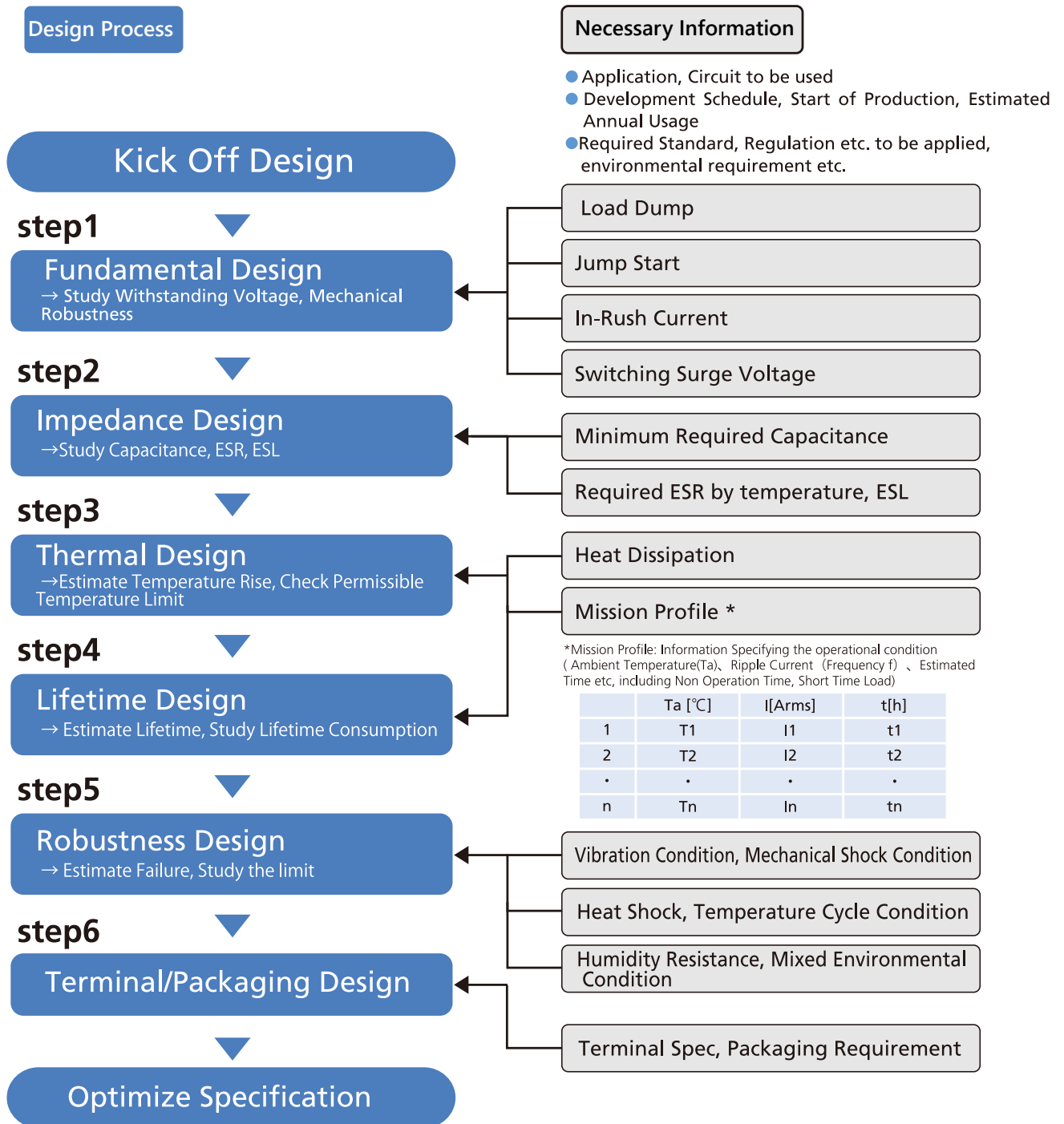

Design for a Highly Reliable, Compact and Cost Competitive product

コンデンサ選定上のキーポイント (Step1)

Key Point in Selecting the best Capacitor (Step 1)

ロードダンプ Load Dump

ロードダンプサージは、一般的に下のような電圧プロファイルで表されますが、コンデンサの耐圧は一般的に温度依存性を有しており、どのような温度範囲でこのような過渡電圧が印加されるか把握しておくことが重要です。例としてアルミ電解コンデンサの陽極箔耐圧の温度依存性のグラフを掲載します。Voltage Profile below shows general Load Dump Surge Voltage. Considering the dependency of withstanding voltage of capacitor on temperature, it is very important to understand at which temperature range the transient voltage is applied. Please refer this example data on temperature dependency of anode foil withstanding voltage of Aluminum Electrolytic Capacitor on temperature.

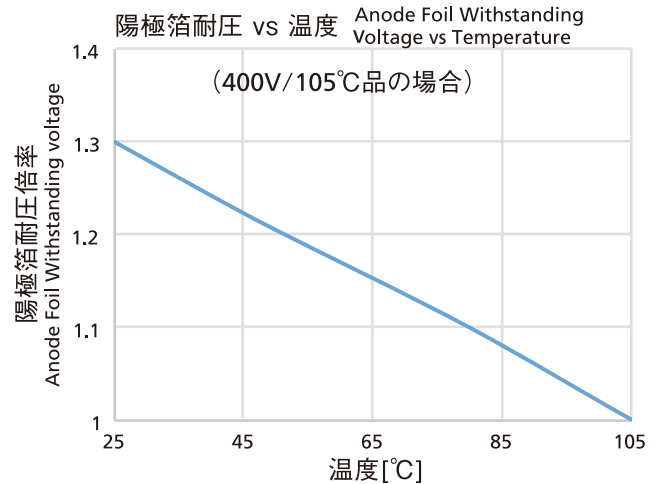
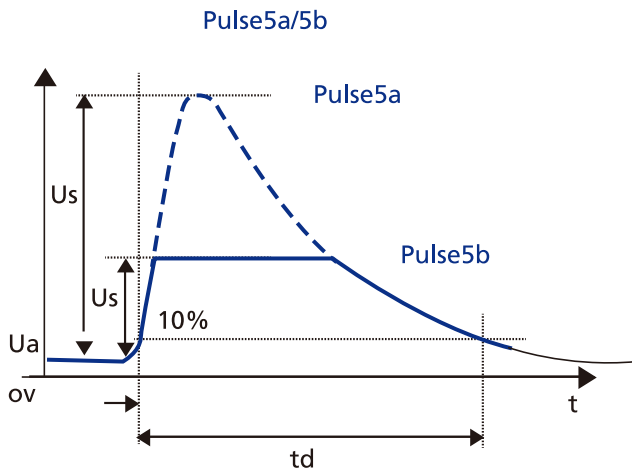

インラッシュカレント In-Rush Current

瞬間的な大電流への耐久性はコンデンサ内の接続部位の電流耐久で決まり、電気的にはヒューズのように振舞います。従って、突入電流のピーク値がどのレベルになるか見積もることが重要です。下の回路図に示すよう、このピーク値はバッテリーラインのラインインピーダンス (L成分とR成分) に大きく依存しますので、このラインインピーダンスを加味して求める必要があります。

Robustness against instantaneous high current depends on robustness of the electrical connection area inside capacitor. This connection point operates in a similar fashion to a single use fuse. It's important to estimate the peak in-rush current to assess if the connection area inside the capacitor can withstand it. The circuit diagram below demonstrates that it is necessary to simulate by considering line impedance since peak of in-rush current heavily depends on the inductance and resistance factor.

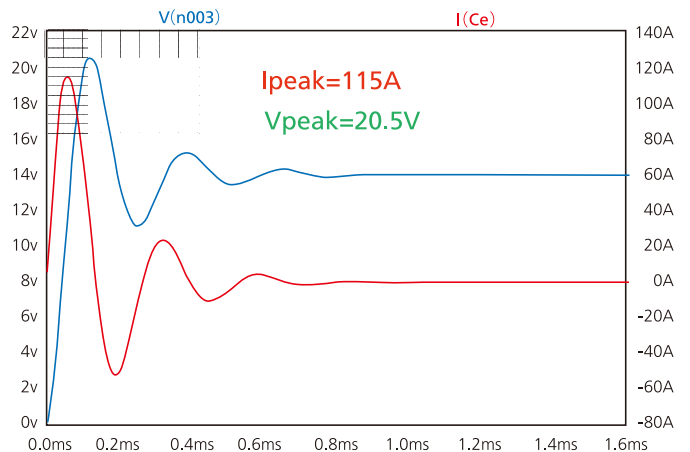
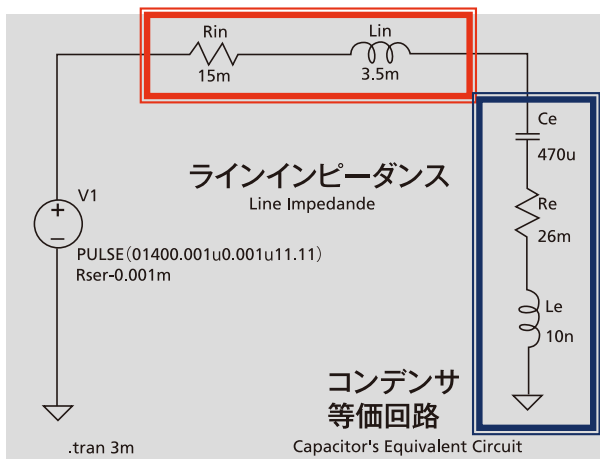

電流ピーク値 → ラインインダクタンスによって大きく変わります。

Peak Current Value largely varies depending on Line Inductance.

コンデンサ選定上のキーポイント (Step2)

Key Point in Selecting the best Capacitor (Step 2)

コンデンサ容量 Capacitance

アルミ電解コンデンサをDCリンク用に使用する場合、そのリップル電流による自己発熱やコンデンサ寿命を要求仕様に合わせると、一般的にコンデンサ容量が実際に必要とされる最低容量よりかなり大きなものとなります。しかし、当社PZ-CAP（機能性高分子材料を使用したアルミ電解コンデンサ）等へ置き換えますと小さなサイズ即ち小さな容量で、そのリップル電流を流すことができます。従いまして、PZ-CAPを用いた回路設計において、システム上最低限必要なコンデンサ容量を把握しておくことが重要です。

When selecting an aluminum electrolytic capacitor for a DC Link application, the internal temperature rise due to ripple current and the capacitor's base life are required in order to confirm if a customer's specification life can be met. The capacitance of selected capacitor is often higher than the required minimum capacitance. However, conductive polymer capacitors such as Rubycon's PZ-CAPs can offer very high ripple current with extremely small package size. This allows for designs that avoid unnecessary higher capacitance than required. Therefore, minimum required capacitance for the circuit is important information to share at the early development stage.

コンデンサバンク仕様置き換え案 Example of Replacement

Al.Cap.

Permissible Ripple current : 60A/10kHz
 Total Capacitance : 3,000 μ F
 Total volume : 72cm³



PZ-CAP

Permissible Ripple current : 60A/10kHz
 Total Capacitance : 900 μ F
 Total volume : 10cm³

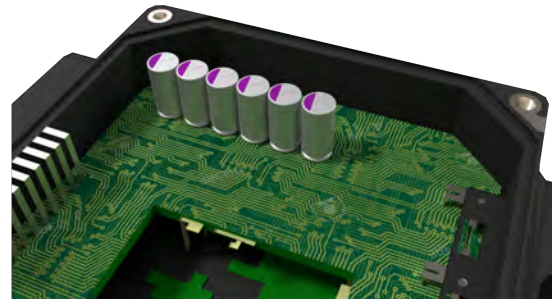

PZ-CAP Capacitance vs Temperature

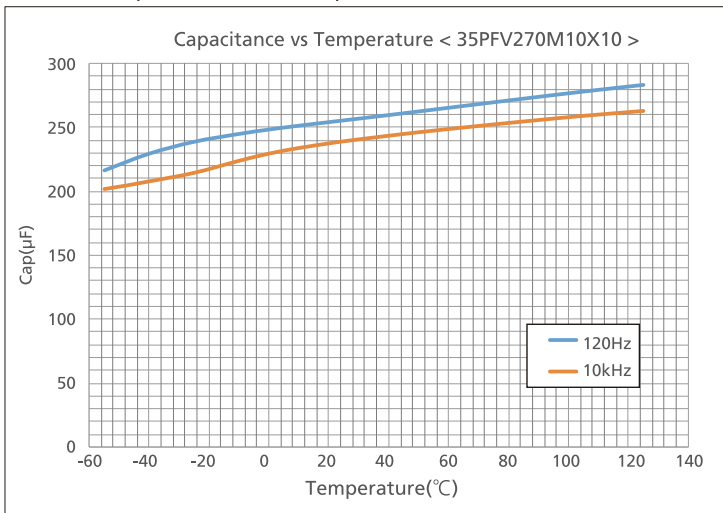

キャリア周波数域(10kHz)でも、広温度範囲で安定した容量出現特性を示します。

Very stable capacitance for wide temperature range even at 10kHz.

コンデンサ選定上のキーポイント (Step2)

Key Point in Selecting the best Capacitor (Step 2)

ESL

ハイブリッド車、電気自動車の駆動用インバータの平滑コンデンサやスナバコンデンサには、フィルムコンデンサが使用されております。これらコンデンサは、高電圧・高電流をチョッピングするスイッチング素子を短絡事故から守るため、できる限り寄生インダクタンス(ESL)を小さくすることが求められております。これを達成するため、当社では有限要素法を用いた最適設計を行なっております。

Film Capacitor are often used as smoothing or snubber capacitors in hybrid and electric vehicles. Inductance (ESL) of this capacitor should be low to protect the switching device chopping voltage/current from a short circuit incident. To achieve this, Rubycon is optimizing the design based on a finite element method.

低ESLデザインの効果 / Low inductance design impact

- サージ電圧による半導体の故障を抑制
Inhibit semiconductor breakdown by surge voltage
- スナバレス化
Snubber less
- コンデンサの発熱の抑制(コンデンサ内部を流れる電流の最適化)
Inhibit capacitor's heat generation (Optimization inside electric circuit)

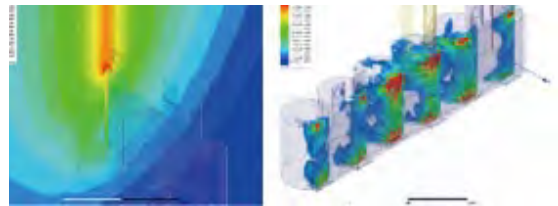
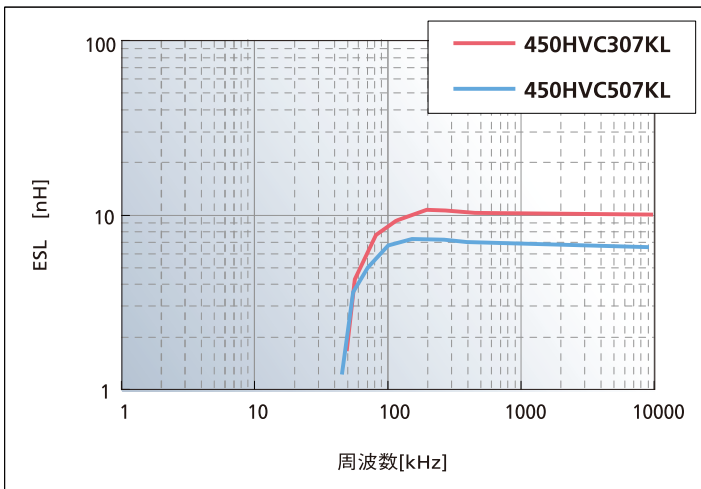

Electromagnetic Analysis

仕様次第で10nH@1MHzを切る事も可能!!
Possible to under 10nH@1MHz depending on specification

MOS FET ターンoff時のVDS波形 / Turn-off voltage of MOS FET

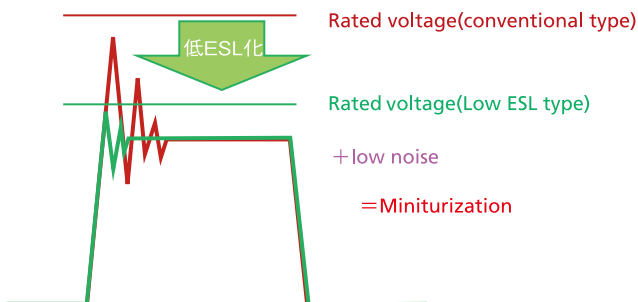

【実施例】

STEP UP
CONVERTER

Vo=800v
Po=30kW
fs=60kHz

Turn-off voltage of MOSFET

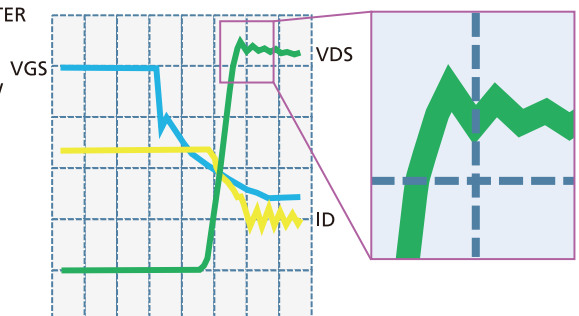

コンデンサ選定上のキーポイント (Step3)

Key Point in Selecting the best Capacitor (Step 3)

発熱量計算 Heat Generation Calculation

あらゆるコンデンサの電流耐久性は、コンデンサ素子の上限温度や許容上昇温度で決められております。そのため、コンデンサに流れるリップル電流を見積もる必要があります。従来、DCリンク用コンデンサは同じ製品を複数並列に使用されてきましたが、機能性高分子を用いた低インピーダンスな電解コンデンサと従来のアルミ電解コンデンサを並列に使用する場合があります。その場合、コンデンサのインピーダンス特性が大きく違うため、回路シミュレーターを用いて各コンデンサに流れる電流と損失を求める必要があります。当社では、以下のような15素子モデルでのフィッティングを行っておりますので、このような場合のシミュレーションに活用下さい。

The amount of current a capacitor can withstand is specified by maximum temperature of the capacitor element (core) or the permissible internal temperature rise. The applied ripple current has to be estimated in such case. Generally, DC Link capacitors are used in parallel connections with same type of capacitor technology. However, there are situations where a combination of capacitor technologies are used in parallel such as conventional aluminum electrolytic combined with conductive polymer type (Rubycon PZ-CAP).

In this case, the calculation of the current applied on each capacitor and the losses need to be calculated via a circuit simulator. Rubycon is calculating with a 15 element models shown below.

15 Element Model

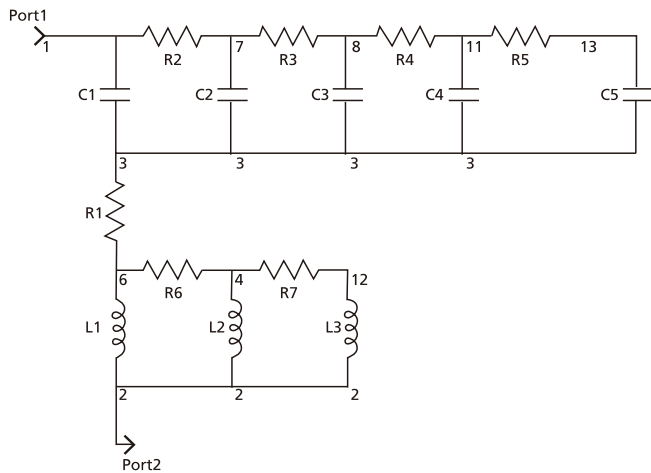

Frequency Characteristics of 15 Element Model

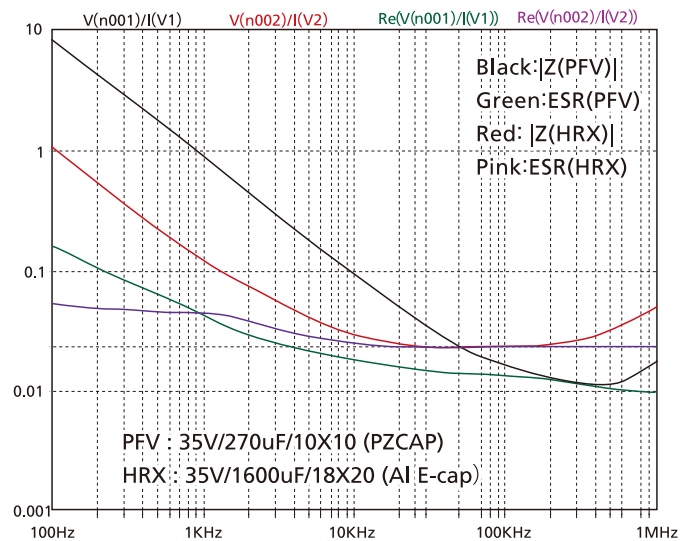

Please refer to the Spice Models of PZ-CAP on Rubycon's web site
<https://www.rubycon.co.jp>

コンデンサ選定上のキーポイント (Step3)

Key Point in Selecting the best Capacitor (Step 3)

熱伝導解析と熱等価回路 Thermal Analysis and Thermal Equivalent Circuit

コンデンサの内部温度推定は、その耐久性（寿命やリップル電流上限値）を評価する上で最も重要なパラメーターです。従って、実使用条件下のコンデンサ温度を正確に見積もることで、安全かつオーバースペックにならない製品提案が可能になります。当社では有限要素法によるコンデンサの熱伝導解析を行っており、実験データと擦り合わせることで、非常に正確な熱等価回路を作成することも可能です。また、一般的な12V/24V系の車載電装設備に使用されるアルミ電解コンデンサやPZ-CAPについて、以下の標準的な熱等価回路モデルの提供が可能です。

The capacitors internal temperature is the most important factor to evaluate its performance (life and maximum ripple current.) It is important to correctly estimate the capacitors temperature under the true operating conditions to avoid unnecessary over spec, while ensuring minimal reliability. Rubycon is doing thermal conductive analysis based on finite element methods. We can offer precise thermal equivalent circuit model (TECM) by utilizing this thermal conductive analysis result and experimental test data. We offer such data for aluminum electrolytic and PZ-CAP hybrid polymer capacitors used for 12V/24V line of automotive applications.

FEM熱伝導解析事例

FEM Thermal Analysis Example

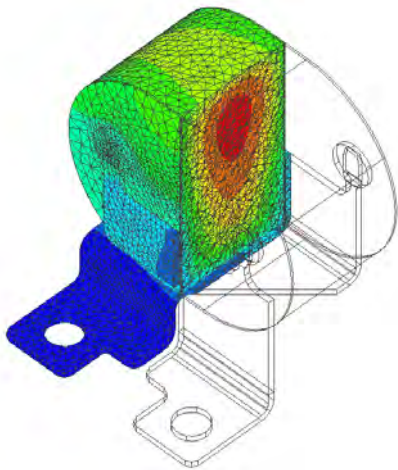

スナバコン素子温度分布

Temperature Distribution of Snubber Film Capacitor

パワーモジュールからコンデンサ端子への放熱(受熱)の影響を解析した事例。

Analysis example of the impact of IGBT heat generation via terminal

熱等価回路事例

Thermal Equivalent Circuit Example

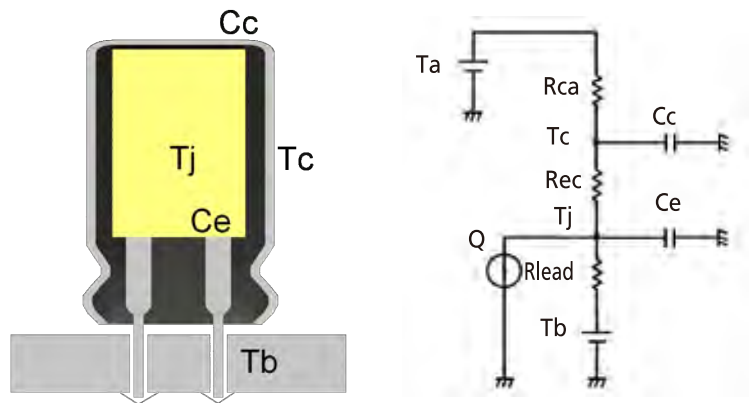

Tj : Element temp. Ce: Element heat capacitance Rca: Rth (Surface to amb.)
 Tc: Surface temp. Cc: Al-case heat capacitance Rec: Rth (Element to surface)
 Tb: PCB temp. Q : Power Loss Rlead: Rth (Element to PCB)
 Ta: Ambient temp.

ラジアルアルミ電解コンデンサ熱等価回路

Aluminum Electrolytic Capacitor-Through Hole Type

コンデンサ選定上のキーポイント (Step4)

Key Point in Selecting the best Capacitor (Step 4)

ミッションプロファイルからの寿命計算を行う Lifetime Expectancy based on Mission Profile

ミッションプロファイルはコンデンサの実使用環境を想定した周囲温度、時間、電流値で構成されています。動作時間、非動作時間、保管時間など想定される条件を区別することも必要です。また、短時間に発生する過渡条件も定常条件と区別して寿命計算することも重要です。

The (Mission Profile) generally consists of ambient temperature, time and ripple current under your actual operating conditions.

It is also important to determine the operating, non operating and storage time. Simulating the transient (peak) conditions which occur less frequently along with the typical conditions are important considerations.

寿命計算例 35HRX3300M18X25

Example of Life Expectancy under Operational condition

時間/周囲温度/電流 Time/Ambient Temperature/Current

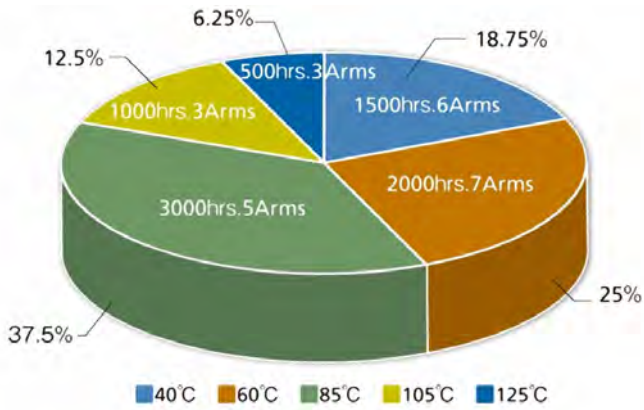

過渡電流条件/コンデンサ発熱推移

Over Current Condition/Heat Generation Change

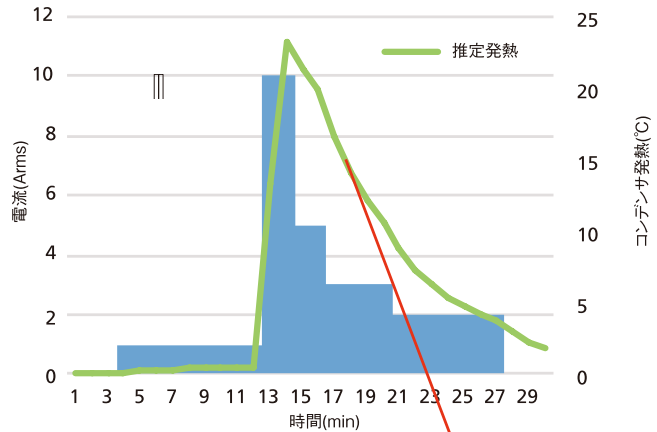

熱モデルからコンデンサの発熱を推定します。高精度な推定を行うためにはコンデンサの実装条件、空冷、水冷などの冷却環境の条件が必要になります。

Simulate Capacitor's temperature rise based on thermal model Further detailed information like capacitor's mounting condition, cooling condition (Air, Water cooling) is also necessary for more precise simulation

Amb.Temp.	Load Time	Ratio	Current	Current/pc	Temp.Rise	consumption
40°C	1500hrs.	18.75%	6Arms	6Arms	20°C	1.5%
60°C	2000hrs.	25%	7Arms	7Arms	27.2°C	21.5%
85°C	3000hrs.	37.75%	5Arms	5Arms	13.9°C	28.9%
105°C	1000hrs.	12.75%	3Arms	3Arms	5°C	8.3%
125°C	500hrs.	6.75%	3Arms	3Arms	5°C	16.7%
	8000hrs.	100%			合計	76.9%



寿命消費率
100%以内:合格
Lifetime Consumption
Within 100%: OK

温度プロファイル推定

Simulate Temperature Profile

寿命消費率推定

Simulate Lifetime Consumption

設計の最適化

Optimize Capacitor Design

温度プロファイル推定:ミッションプロファイル+熱回路モデル(冷却条件加味)からコンデンサ温度を推定

寿命消費率:推定温度プロファイルから寿命消費率を計算

妥当性判定:寿命消費率、占有体積などをお客様と協議し最終コンデンサ仕様を確定

Temperature Profile Simulation : Simulate Capacitor temperature based on Mission Profile and Thermal Model (including cooling conditions)

Life Consumption Simulation : Simulate Life Consumption based on Temperature profile

Assessment : Determine Best Capacitor Design by communicating with customer the simulation result and the required condition like lifetime and size of capacitor.

コンデンサ選定上のキーポイント (Step4)

Key Point in Selecting the best Capacitor (Step 4)

耐振動性 Anti Vibration

φ10×10以下のサイズのSMDタイプのPZ-CAP並びにアルミ電解コンデンサは、10Hz～500Hzの周波数範囲で20Gの耐振動性を有しております。また、これらの製品の座板を耐振座板に変えた耐振動構造品は、10Hz～1kHzの範囲で30Gの耐久を有しております。

従って、通常要求される加速度に対して十分な耐力を有しております。しかし、周波数範囲がさらに高い周波数を含みますと共振現象が起き、より小さな加速度でも壊れる可能性があります。

当社では、これらの振動現象について調査するためレザードップラー振動計による解析を行っています。

For 10x10mm sizes and smaller, standard surface mount capacitors (Aluminum Electrolytic Capacitor and PZ-CAP) can withstand 20G at 10Hz~500Hz. In addition, we offer an Anti Vibration Option "VB" which includes an extended base and additional soldering area to enhance vibration performance. This option can withstand 30G at 10Hz~1kHz.

However, when the frequency range contains higher frequency then what is shown below, a resonance may occur which can cause damage even if the acceleration were smaller. Rubycon can offer the analysis on such vibration phenomenon via a Laser Doppler Vibrometer.

耐振動構造品

Anti Vibration Type SMD



	A1, B1	C	P
φ8	8.3	3.1	3.1
φ10	10.3	3.4	4.5
φ12	13	4.9	4.5
φ16	17	6	6.8
φ18	19	7	6.8

通常品と耐振動構造品の共振点比較

Resonance Point Compariton: Standard SMD vs Anti Vibration Type SMD

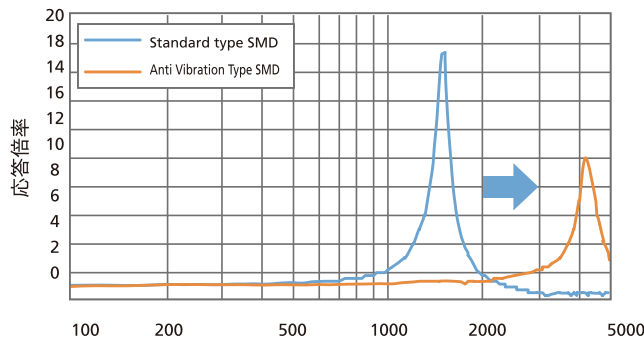

耐振構造により共振点が高周波側へシフト(想定振動域外に共振点があることが重要)

Anti-vibration structure shift the resonance frequency to higher range and depress the magnitude of response function. The key point is the resonance frequency exists out of usage frequency range

<φ8, φ10>

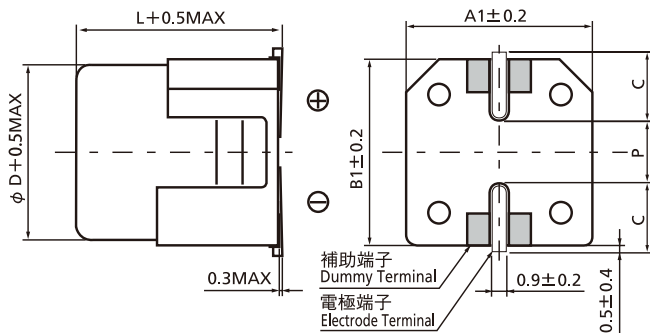

<φ12.5~φ18>

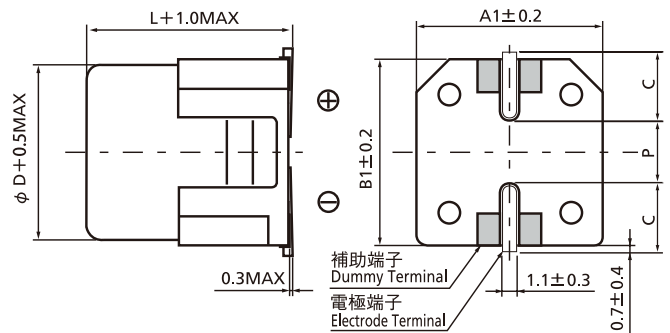

A Changing world of vehicle with innovative Rubycon design



本カタログの記載内容は、2022年1月現在のものです。品名・仕様は予告なく変更、あるいは製造を中止する場合がございます。本カタログの記載内容は、製品の紹介資料です。ご使用にあたりましては別途仕様書を必ずご請求の上、ご確認ください。

The contents presented in this catalog have been update as of January 2022. Product name and specification are subject to change or cancellation of production without notice.

The contents presented in this catalog is an introductory document of the product. Please ask the detailed specification when using the products contained in this catalog.

極めて高信頼性を要求される回路、社会的に重大な影響を与えかつ直接生命・身体に対する危険を伴う用途（交通輸送機器・医療機器・航空機器・宇宙機器・原子力用機器等）に使用される場合には、事前にご相談ください。

Our products is not used in special circuit (transportation equipment , medical equipment , aerospace equipment , space equipment , nuclear equipment etc) where a defect in this component may cause the loss of human life or other significant damage in the case of high reliability application circuit/equipment , Please contact us in advance.



RUBYCON CORPORATION