

Capacitors Catalog

**FILM CAPACITORS
POLYMER MULTI-LAYER CAPACITORS**

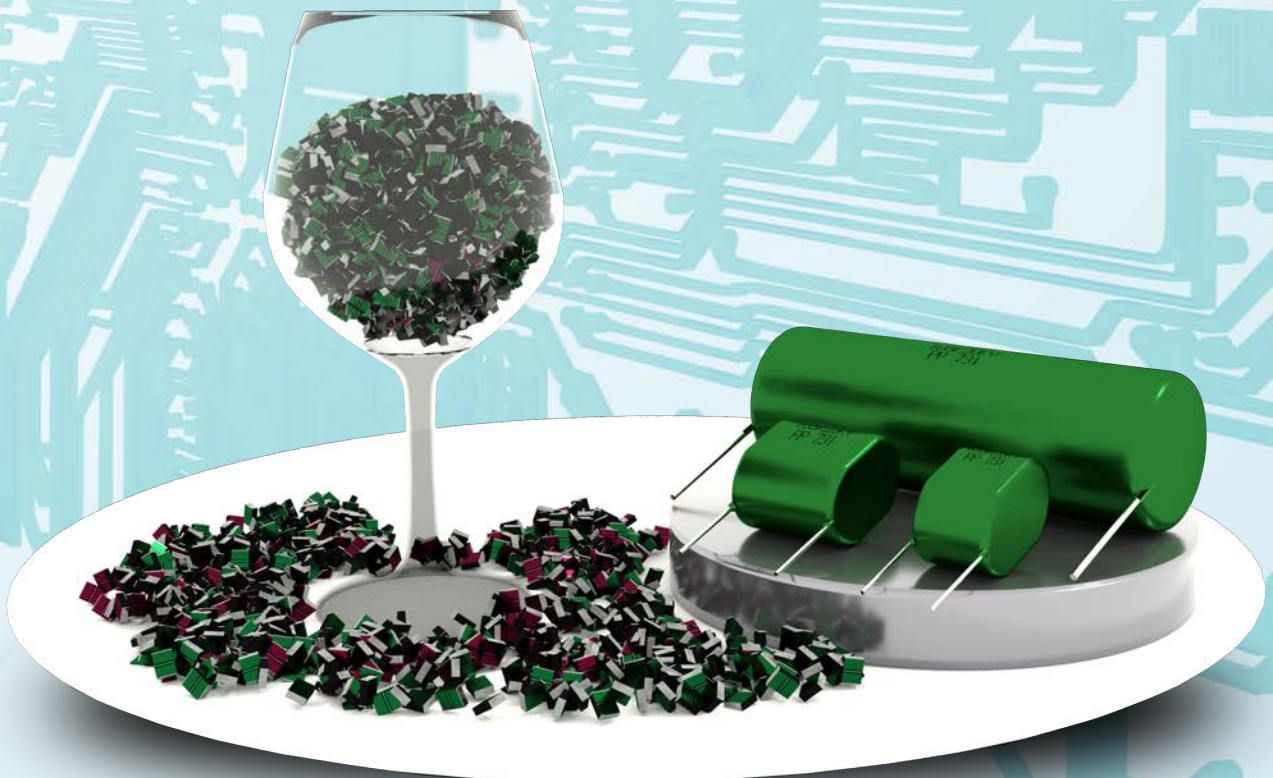

◆フィルムコンデンサ/FILM CAPACITORS

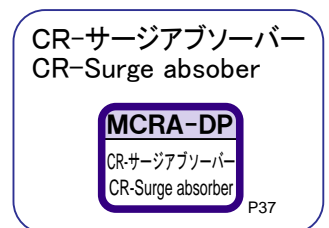
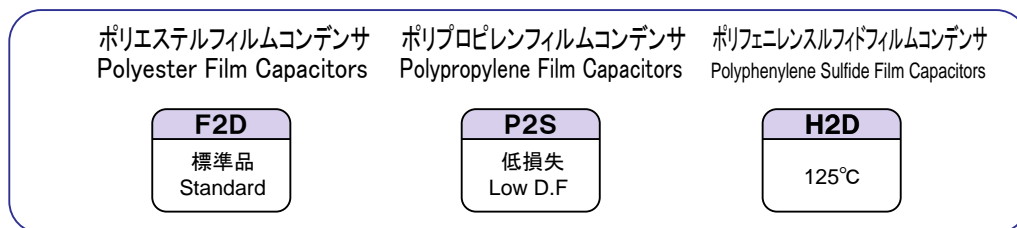
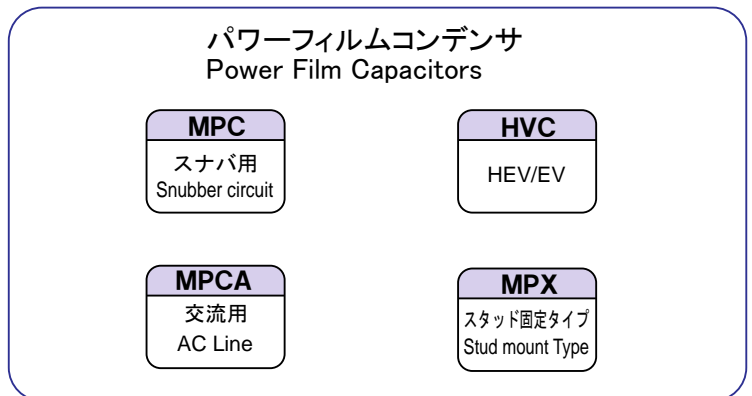
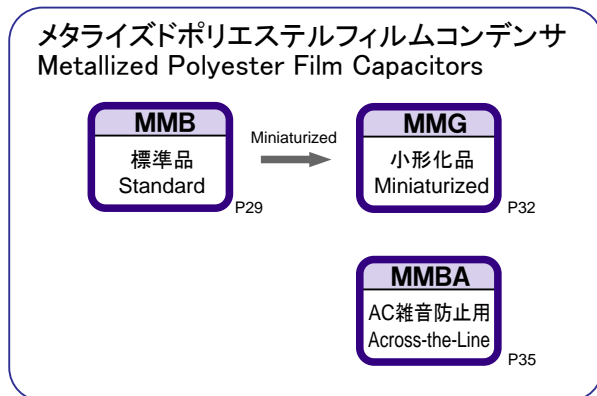
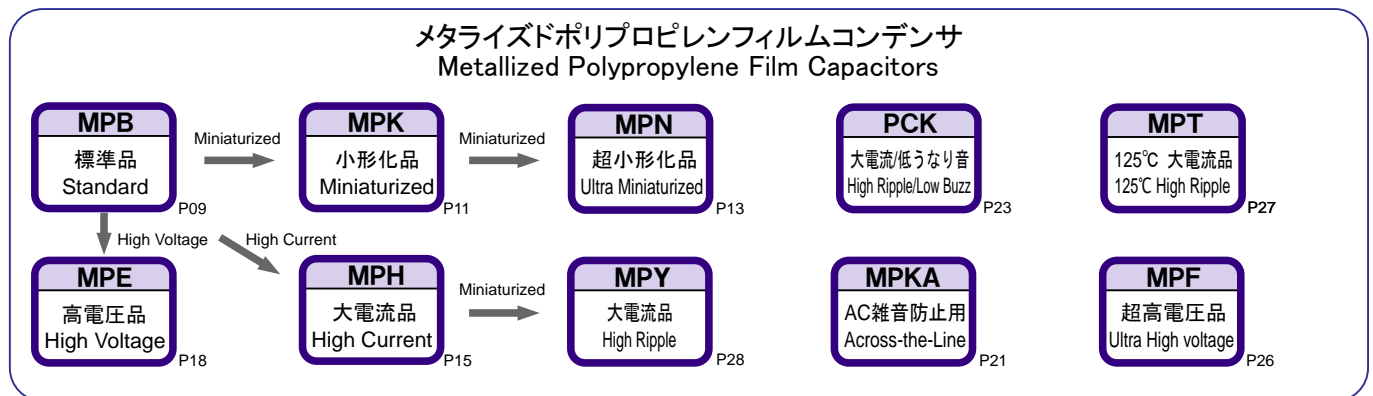

◆薄膜高分子積層コンデンサ "PMLCAP" / POLYMER MULTI-LAYER CAPACITORS

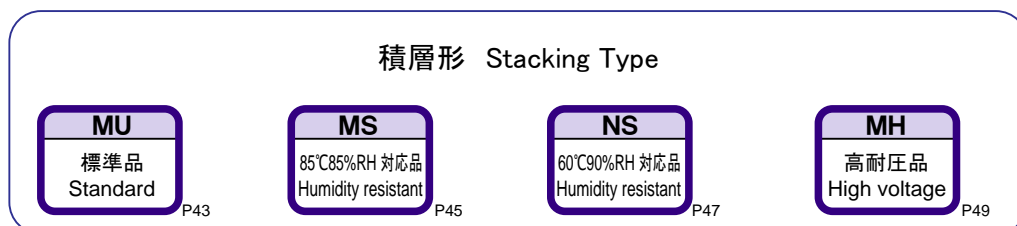

◆CONTENTS

使用上の注意事項 フィルムコンデンサ CAUTION FOR PROPER USE OF FILM CAPACITORS P02
使用上の注意事項 薄膜高分子積層コンデンサ "PMLCAP" CAUTION FOR PROPER USE OF PMLCAP P38
RoHS規制物質への対応 / Conforming to RoHS Directive P50
カタログ削除品、旧シリーズについてのお願い PROPOSAL ON DELETION OF OLD SERIES FROM CATALOG P50

フィルムコンデンサの使用上の注意事項

フィルムコンデンサの選定、ご使用に際しては、次の点にご注意ください。なお、カタログ掲載の仕様、材質その他の記載内容について、予告なく変更する場合がありますので、予めご了承ください。また、カタログ掲載のデータは代表値であり、性能を保証するものではありません。

ご注文に際して

フィルムコンデンサのご注文に際しては、次の事項をご照会ください。

1. 使用電圧: DC, AC
2. 静電容量及び許容差
3. 使用温度範囲
4. 特殊使用条件: 電圧・電流波形、波高値及び実効値、周波数、パルス等
5. 予測故障モード: コンデンサの故障の他の部品への影響、または他の部品、回路の異常のコンデンサへの影響等
6. はんだ付け条件
7. 使用環境
8. その他

なお、事前に該当コンデンサについての弊社納入仕様書等をお求めいただき、上記内容を満足しているか十分ご確認のうえ、ご購入及びご使用ください。

1. 定格電圧

定格電圧は定格温度においてコンデンサに連続印加できるせん頭電圧(直流電圧及び個別規格で規定される値以下の交流電圧せん頭値の和)の最大値です。電子機器用コンデンサの定格電圧は、特殊なものを除き、通常DCで示しております。

- 1). DC定格のものをAC回路(電源ライン間挿入を除く)でご使用の場合は、発熱・放電等がありますので、Table 1 の定格内でご使用ください。

CAUTION FOR PROPER USE OF FILM CAPACITORS

Please consider the following information when selecting and using capacitors.

Specifications, materials and so on in the catalog may be subject to change without notice.

Data in the catalog is not guaranteed value, but typical value only.

ORDERING INFORMATION

Please confirm and inform us of the following information when ordering capacitors.

1. Working voltage : AC or DC
2. Capacitance and capacitance tolerance
3. Operating temperature range
4. Special operating condition : waveform, effective value, crest value, frequency, pulse, etc.
5. Expected failure mode : Influence to other components, when the capacitor gets failure, or influence to the capacitor, when the other component or the circuit works irregularly.
6. Soldering condition
7. Operating environmental condition

Ask for our technical specifications of the capacitor and confirm it to be suitable for the application before purchase and/or use.

1. RATED VOLTAGE

Rated voltage is the maximum peak voltage (sum of D.C. voltage and peak A.C. voltage which is no more than the value specified in the individual specification) which may be applied to a capacitor continuously at its rated temperature.

Rated voltage of capacitors for electronic equipment is usually DC voltage. (Unless otherwise specified)

- 1). When a D.C. rated capacitor is used in an A.C. circuit, the capacitor generates heat except for an across the line capacitor.

We recommend using capacitors below the voltage shown in Table 1.

Table 1

DC 定格電圧 DC Rated Voltage	AC 定格電圧 AC Rated Voltage [Vrms (50, 60Hz)]								
	MPB	MPH	MPK	MPN	MPE	MMB	F2D	P2S	H2D
50V	-	-	-	-	-	-	30	-	30
100V	-	※	-	-	-	50	50	50	50
200V	-	-	-	-	-	-	100	-	-
250V	125	125	-	-	-	125	-	125	-
400V	-	-	-	-	-	200	-	-	-
450V	200	200	150	100	-	-	-	-	-
630V	250	250	200	150	-	250	-	-	-
800V	-	※	※	-	250	-	-	-	-
1250V	-	-	-	-	400	-	-	-	-
1600V	-	-	-	-	700	-	-	-	-

※この製品のAC定格についてはお問い合わせください。

For AC rated voltage of this item, please consult our sales offices.

・品種によりAC定格が多少異なる場合がありますので、詳細はお問い合わせください。

AC rated voltage of Table 1 is not applicable to all kinds of capacitors. Please inquire us to details.

・上記以外の製品についてはお問い合わせください。

For other series, please consult our sales offices.

- 2). 使用温度による定格電圧軽減
コンデンサを高温で使用すると熱劣化によりコンデンサ寿命が低下します。高温でご使用の場合は、下記グラフに従いまして使用電圧を軽減してください。
(Fig1 ~2)

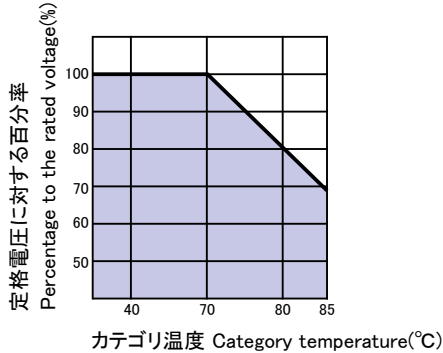

Fig 1
適用品種 / Application series
P2S

- 2). Rated voltage derating by category temperature
Use of the capacitors at high temperature shortens the capacitor life due to thermal deterioration. When operating capacitors at high temperature, please derate the operating voltage in conformance with the graphs below.
(Fig1 ~2)

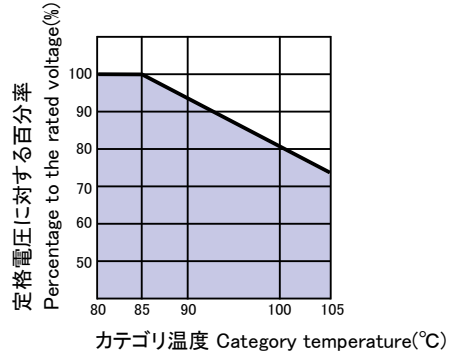

Fig 2
適用品種 / Application series
MPK, PCK, MMB, MMG, F2D

- 3). 高周波使用に対する定格電圧軽減
コンデンサを高周波で使用すると自己発熱によりコンデンサ寿命が低下します。高周波で使用される場合は仕様書にて確認して頂き使用電圧を軽減してください。
- 4). 特殊波形で使用する場合
正弦波以外の特殊波形で使用する場合は、実効値がそれぞれ異なりますので、詳細は電流波形をご確認の上お問い合わせください。

- 3). Rated voltage derating by high frequency
Using a capacitors at high frequency will shorten its life due to the generation of heat. When operating capacitors at high frequency, please reduce the operating voltage according to specification sheet.
- 4). Use in special wave form
If you want to use the capacitor with a special wave-form other than a sine wave, please inquire to us for details after identifying the wave-form with which the capacitor is required to be used, because the effective value varies with wave-form.

(注)DCバイアス分を含む場合、DC定格電圧からバイアス電圧を引いた交流電圧を許容値とし、この電圧を各周波数により軽減し、ご使用ください。

(NOTE) Where a DC bias is voltage included, the DC rated voltage minus the DC bias voltage becomes the permissible AC voltage, and this AC voltage shall be derated depending on the frequency.

2.許容電流

- 1). 周波数に対する許容電流
コンデンサを交流で使用される場合は、シリーズ別に示した周波数に対する許容電流の実効電流値以下でご使用ください。(個別ページ)

2. PERMISSIBLE CURRENT

- 1). PERMISSIBLE CURRENT FOR FREQUENCY
When using capacitors with an alternating current, effective current should not exceed the value of permissible current for frequency shown in the graph of each series.(individual page)

2). 許容ピーク電流値 (パルス電流)
 正弦波以外で使用される場合は、その実効電流値が許容範囲内で、且つシリーズ別に示した Table 2 の単発許容ピーク電流値以下でご使用ください。

2). Permissible peak current (pulse current)
 When in use for non-sine current wave, effective current should not exceed the permissible value and also, peak current should not exceed the following permissible

Table 2

(A_{o-p})

静電容量 Capacitance (μ F)	MPB			MPK			MPH				MPE		PCK								MMB						
	250Vdc	450Vdc	630Vdc	450Vdc	630Vdc	800Vdc	100Vdc	250Vdc	450Vdc	630Vdc	800Vdc	800Vdc	1250Vdc	1600Vdc	450Vdc	630Vdc	800Vdc	1000Vdc	1250Vdc	1600Vdc	2000Vdc	100Vdc	250Vdc	400Vdc	630Vdc		
0.001	-	-	-	-	-	-	-	-	-	-	-	-	6	6	-	-	-	-	-	-	-	-	-	-	-	-	
0.0012	-	-	-	-	-	-	-	-	-	-	-	-	7	7	-	-	-	-	-	-	-	-	-	-	-	-	
0.0015	-	-	-	-	-	-	-	-	-	-	-	-	9	9	-	-	-	-	-	-	-	-	-	-	-	-	
0.0018	-	-	-	-	-	-	-	-	-	-	-	-	10	10	-	-	-	-	-	-	-	-	-	-	-	-	
0.0022	-	-	-	-	-	-	-	-	-	-	-	-	9	13	-	-	-	-	-	-	-	-	-	-	-	-	
0.0027	-	-	-	-	-	-	-	-	-	-	-	-	12	16	-	-	-	-	-	-	-	-	-	-	-	-	
0.0033	-	-	-	-	-	-	-	-	-	-	-	-	14	19	-	-	-	-	-	-	-	-	-	-	-	-	
0.0039	-	-	-	-	-	-	-	-	-	-	-	-	17	22	-	-	-	-	-	-	-	-	-	-	-	-	
0.0047	-	-	-	-	-	-	-	-	-	-	-	-	20	27	-	-	-	-	-	-	-	-	-	-	-	-	
0.0056	-	-	-	-	-	-	-	-	-	-	-	-	24	32	-	-	-	-	-	-	-	-	-	-	-	-	
0.0068	-	-	-	-	-	-	-	-	-	-	-	-	29	39	-	-	-	-	-	-	-	-	-	-	-	-	
0.0082	-	-	-	-	-	-	-	-	-	-	-	-	24	47	-	-	-	-	-	-	-	-	-	-	-	-	
0.01	9	9	9	-	-	-	-	-	-	-	-	-	29	58	-	-	-	-	-	-	-	3	-	-	-	5	
0.012	10	10	10	-	-	-	-	-	-	-	-	-	35	69	-	-	-	-	-	-	-	4	-	-	-	6	
0.015	13	13	13	-	-	-	-	-	-	-	-	-	43	86	-	-	-	-	-	-	-	5	-	-	-	8	
0.018	16	16	16	-	-	-	-	-	-	-	-	-	52	104	-	-	-	-	-	-	-	6	-	-	-	10	
0.022	19	19	14	-	-	-	-	-	-	-	-	-	53	63	127	-	-	-	-	-	-	7	-	-	-	10	
0.027	24	24	18	-	-	-	-	-	-	-	-	-	65	78	155	-	-	-	-	-	-	9	-	-	-	12	
0.033	15	15	22	-	-	-	-	-	-	-	-	-	79	95	190	-	-	-	-	-	-	11	-	-	-	15	
0.039	18	18	25	-	-	-	-	-	-	-	-	-	93	112	200	-	-	-	-	-	-	12	-	-	10	17	
0.047	22	22	16	-	-	-	-	-	-	31	-	113	135	200	-	-	-	-	-	-	-	15	-	-	12	21	
0.056	26	26	19	-	-	-	-	-	-	37	-	134	161	200	-	-	-	-	-	-	-	8	-	-	14	13	
0.068	25	32	23	-	-	-	-	-	-	44	-	163	196	200	-	-	-	-	-	-	-	10	-	-	17	16	
0.082	30	38	28	-	-	-	-	-	-	54	-	197	200	200	-	-	-	-	-	-	-	12	-	-	20	19	
0.1	31	21	34	-	35	-	-	50	60	66	-	200	200	200	-	-	-	-	-	-	32	14	-	25	25	23	
0.12	37	25	41	-	42	-	-	60	72	79	-	200	200	-	-	-	-	-	-	-	38	17	-	30	17	28	
0.15	46	31	51	-	52	-	-	75	56	98	-	200	200	-	-	-	-	-	-	-	48	22	-	37	21	35	
0.18	45	38	62	-	63	-	-	90	67	118	-	200	200	-	-	-	-	-	-	-	58	18	-	30	25	42	
0.22	54	46	75	-	77	-	-	88	81	144	111	200	200	-	-	-	-	-	89	42	23	-	37	31	51		
0.27	67	56	63	-	41	-	-	108	100	93	136	200	200	-	-	-	-	-	109	52	-	-	45	38	38		
0.33	81	69	77	-	50	-	-	132	122	113	167	200	200	-	-	-	-	-	133	63	-	-	55	47	46		
0.39	54	81	90	-	59	-	-	96	144	134	197	200	-	-	-	-	-	-	157	75	-	-	37	55	54		
0.47	66	98	109	47	72	60	-	116	174	161	200	200	-	-	-	-	-	-	190	90	-	-	44	66	65		
0.56	78	81	130	55	85	72	-	138	117	192	200	200	-	-	-	-	-	-	200	-	-	-	61	53	49	78	
0.68	95	99	158	67	103	87	-	167	142	200	198	-	-	-	-	-	-	122	170	200	-	-	74	64	60	95	
0.82	114	119	190	81	75	105	-	200	171	200	200	-	-	-	-	-	-	147	200	200	-	-	89	77	72	89	
1	139	145	200	99	91	128	-	200	200	200	200	-	-	-	-	-	-	128	179	200	200	-	-	108	94	88	108
1.2	167	174	-	119	110	119	-	200	200	200	-	-	-	-	-	-	-	153	200	200	200	-	-	85	113	105	130
1.5	146	200	-	149	137	149	-	200	200	200	-	-	-	-	-	-	-	192	200	200	200	-	-	106	141	104	162
1.8	175	200	-	179	164	179	-	200	200	200	-	-	-	-	-	-	-	200	200	200	200	-	-	127	105	124	195
2.2	200	200	-	200	200	200	-	200	200	200	-	-	-	-	182	200	200	200	200	200	-	-	-	155	129	152	200
2.7	200	-	-	200	-	-	-	200	200	-	-	-	-	-	200	200	200	200	200	200	-	-	-	191	158	187	-
3.3	200	-	-	200	-	-	-	200	200	-	-	-	-	-	200	200	200	200	200	200	-	-	-	200	193	200	-
3.9	200	-	-	200	-	-	-	200	200	-	-	-	-	-	200	200	200	200	-	-	-	-	-	171	200	200	-
4.7	200	-	-	200	-	-	200	200	200	-	-	-	-	-	200	200	200	200	-	-	-	-	-	200	200	200	-
5.6	-	-	-	-	-	-	200	200	-	-	-	-	-	-	200	200	200	-	-	-	-	-	-	200	200	-	-
6.8	-	-	-	-	-	-	200	200	-	-	-	-	-	-	200	200	200	-	-	-	-	-	-	200	200	-	-
8.2	-	-	-	-	-	-	200	200	-	-	-	-	-	-	200	200	200	-	-	-	-	-	-	200	200	-	-
10	-	-	-	-	-	-	200	200	-	-	-	-	-	-	200	200	200	-	-	-	-	-	-	200	200	-	-
12	-	-	-	-	-	-	200	-	-	-	-	-	-	-	200	200	-	-	-	-	-	-	-	-	-	-	-
15	-	-	-	-	-	-	200	-	-	-	-	-	-	-	200	200	-	-	-	-	-	-	-	-	-	-	-
18	-	-	-	-	-	-	200	-	-	-	-	-	-	-	200	-	-	-	-	-	-	-	-	-	-	-	-
22	-	-	-	-	-	-	200	-	-	-	-	-	-	-	200	-	-	-	-	-	-	-	-	-	-	-	-
27	-	-	-	-	-	-	-	-	-	-	-	-	-	-	200	-	-	-	-	-	-	-	-	-	-	-	-
33	-	-	-	-	-	-	-	-	-	-	-	-	-	-	200	-	-	-	-	-	-	-	-	-	-	-	-

・電流値が上記の値を超える場合はご相談ください。 / In case operating current may exceed the above values, please consult us.
 ・上記以外の製品についてはお問い合わせください。 / For other series, please consult our sales offices.

3.自己温度上昇

リップル電流による温度上昇、交流電圧による温度上昇、高周波回路による温度上昇等により、コンデンサが自己発熱をしますが、この自己発熱が大きいと、劣化、損傷の危険がありますので、コンデンサの自己温度上昇は、Table 3 の範囲内でご使用ください。

3.SELF HEAT RISE

Due to ripple current, A.C. voltage, and/or high frequency circuit, capacitors generate heat. Capacitors may degrade or damage themselves in case of excessive self heat rise. We recommend self heat rise limits of Table 3.

Table 3

コンデンサの種類 Type of capacitors	自己温度上昇 Self heat rise limits	適用品種 Application Series
ポリエステルフィルムコンデンサ Polyester Film Capacitor	10°C以内 Within 10°C	F2D
メタライズドポリエステルフィルムコンデンサ Metallized Polyester Film Capacitor	15°C以内 Within 15°C	MMB, MMG, MMBA
ポリプロピレンフィルムコンデンサ Polypropylene Film Capacitor	8°C以内 Within 8°C	P2S
メタライズドポリプロピレンフィルムコンデンサ Metallized Polypropylene Film Capacitor	8°C以内 Within 8°C	MPK, MPN, MPKA
	10°C以内 Within 10°C	MPB, MPH, MPE
	15°C以内 Within 15°C	MPY,PCK
	20°C以内 Within 20°C	MPT
ポリフェニレンスルフィドフィルムコンデンサ Polyphenylene Sulfide Film Capacitor	15°C以内 Within 15°C	H2D

4.カテゴリ温度

コンデンサを連続して使用できる周囲温度の範囲です。

4.CATEGORY TEMPERATURE

Atmospheric temperature range at which a capacitor may be used continuously.

1). カテゴリ上限

コンデンサを連続して使用できる周囲温度の最高値です。ただし、コンデンサが他の熱源からの放射や伝導を受け、また交流電圧又は直流電圧に含まれる交流分(リップル)によって温度が上昇するときは、コンデンサ表面の最高温度をカテゴリ上限温度とみなします。

1). Upper category temperature

The maximum ambient temperature at which a capacitor may be used continuously. However, when the temperature of the capacitor goes up due to radiation or conduction from other heat sources, and/or A.C. components included in A.C. voltage or in D.C. voltage (ripple), the maximum temperature at the surface of the capacitor shall be considered as the upper category temperature.

2). カテゴリ下限

コンデンサを連続して使用できる周囲温度の最低値です。

2). Lower category temperature

The minimum ambient temperature at which a capacitor may be used continuously.

5.充放電回路にご使用の場合

急激な充放電は、コンデンサの特性劣化や破壊につながりますので、事前にご相談ください。

5.FOR CHARGE AND DISCHARGE

Rapid charge and discharge to capacitors under heavy condition may result in failure of capacitors. For this application, consult us in advance.

6.うなり音

使用条件により、コンデンサの端子間に交流電圧が印加される場合、クーロン力の作用によって誘電体フィルムの機械的振動が生じ、うなり音を発生する場合があります。電源電圧の歪、高周波成分によっては、高いレベルの音となる場合がありますので、うなり音が問題となるような用途にご使用の場合は、ご相談ください。

6.BUZZ

During AC operation, as the case may be, the capacitor may make buzzing noise due to mechanical vibration of the film caused the coulomb force which exists between electrodes opposite polarity. A louder buzz is made when applied voltage waveform has distortion, and/or higher frequency component, etc. Consult us if buzz made by the capacitor influence as he application.

7.時定数回路等に使用する場合

コンデンサはその環境条件によって特性変化があります。一般の使用状態においても空気中の湿度により若干の容量変化があり、この容量変化は誘電体によって異なります。時定数回路等で容量変化の少ない製品が必要な場合には、ポリプロピレンを誘電体とした、P2Sシリーズをご使用ください。

7.USE IN CIRCUITS SUCH AS TIME-CONSTANTS

The characteristics of a capacitor vary with environmental conditions. Even in the general working state, its electrostatic capacity varies somewhat with the level of humidity in the air, and this change in electrostatic capacity varies with the dielectric used. Rubycon recommend to use P2S series when use in circuits require stable capacity such as time-constants.

8.湿度の高い環境で使用する場合

湿度の高い環境で長時間使用すると、外装を通して素子が吸湿し、コンデンサの故障要因となります。高温条件でご使用される場合は、ご相談ください。

9.はんだ付作業

はんだ付作業は、下図に示す時間及び温度以内で行ってください。これ以外になりますと外装亀裂、ショート、容量低下の原因になります。はんだ付作業を繰り返して行う場合は、コンデンサ本体の温度が充分に下がってから行ってください。

リード付タイプは、リフローはんだ付けしないでください。

※) P2S についてはfig 5の条件でも基板の厚さ、プリヒートの条件等により問題となる場合がありますのでご注意ください。

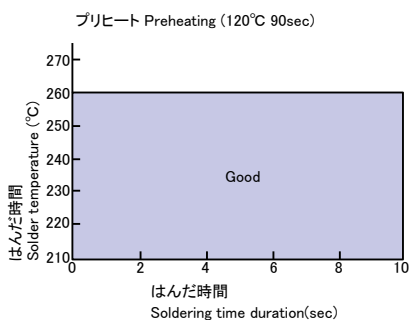

Fig 3

摘要品種 Application series
MMB, MMG, MMBA
F2D, H2D

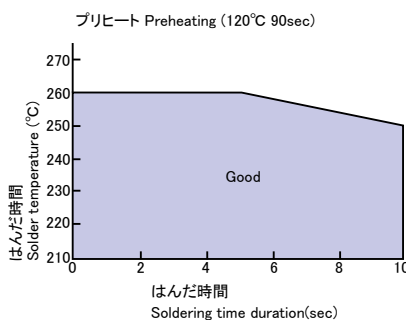

Fig 4

摘要品種 Application series
MPB, MPK, MPN, MPH, MPE
MPKA, PCK, MPT, MPY

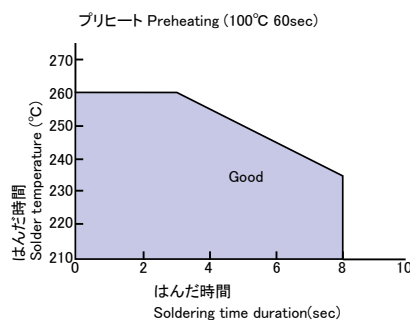

Fig 5

摘要品種 Application series
P2S

手はんだ付けの場合、こて先温度350°C、加熱時間3秒以内を1回とし、こて先直径は3mm以内としてください。

10.洗浄(溶剤)について

基板洗浄に使用する溶剤は、アルコール系などの影響の少ないものをご使用ください。(具体的溶剤、洗浄方法等詳細はお問い合わせください。)

11.保管条件

保管場所は室内で30°C以下、相対湿度75%以下で、急激な温度変化、直射日光、腐食性ガスのある環境に保管しないでください。

上記条件における保管期限は原則として製造後一年以内です。

12.廃棄の場合

コンデンサを廃棄する場合は専門の産業廃棄物処理業者に依頼してください。

13.その他

- ・参考文献: 電子機器用固定プラスチックフィルムコンデンサ使用上の注意事項ガイドライン(電子情報技術産業協会技術レポートJEITA RCR-2350D)
- ・使用条件その他については、当社営業にお問い合わせください。

8.USE IN HUMID ENVIRONMENT

When used for a long time in humid environment, the capacitor elements absorb moisture. As a result, the capacitor might break down. When used under the humid condition, please consult us.

9.SOLDERING OPERATION

When capacitors are sustained at high temperature in soldering operations, it invites short circuits or other failures due to deteriorations of the film so please observe the limitations specified in the graphs below. Avoid reflow soldering the lead type.

※) Even under the conditions shown in fig 5, types P2S, may pose problems according to circuit board thickness and preheating conditions. So, please pay attention to this point.

When using soldering iron, temperature of iron shall be 350°C, applied duration within 3sec as 1time.

10.CLEANING SOLVENTS

When a solvent is used for cleaning etc., inactive material such as alcohol, etc. should be used. (For a more technical information, consult our engineering)

11.STORAGE CONDITION

A storage needs to be kept indoors at less than 30°C and relative humidity of under 75% without any sudden temperature changes, direct sunlights and corrosive gas around.

Storage period in the above conditions is within one

12.DISPOSAL

In case of rejecting capacitors, please seek for professionals who deal with the industrial wastes treatment.

13.OTHERS

- ・Quoted documents: Guideline of notabilia for fixed plastic film capacitors for use in electronic equipment (Technical Report of Japan Electronics and Information Technology Industries Association, JEITA RCR-2350C)
- ・For further particulars, please apply to our sales offices.

◆呼称方法/PART NUMBER

□□□	□□□□	□□□	□	□□□	□□□	□□□□□																				
定格電圧 Rated Voltage	シリーズ名 Series	静電容量 Capacitance	静電容量許容差 Capacitance Tolerance	副記号 Option	リード加工記号 Lead Forming	特殊記号 Special number																				
	↑ シリーズ名を表す Denoting "Series name"		↑ 静電容量許容差 を記号で表す Symbol denoting rated capacitance tolerance	↑ シリーズ名の 補助記号 Denoting "Support of Series name"	↑ 加工形状等を表す記号 Symbol denoting Lead style	↑ 特殊仕様を表す 記号 Denoting special spec																				
定格電圧を数字で表す (1000V 以上は記号で表す) Denoting rated voltage by figure, but more than 1000V by sign. 例/Example 1000V→101, 1600V→161		静電容量を表す Symbol denoting capacitance expressed in pF. The first two digits are significant figures of capacitance. The third digit is the number of zeros to follow the significant figures.		<table border="1" style="margin-left: auto; margin-right: auto;"> <tr><th>Tolerance</th><th>Code</th></tr> <tr><td>±2%</td><td>G</td></tr> <tr><td>±3%</td><td>H</td></tr> <tr><td>±5%</td><td>J</td></tr> <tr><td>±10%</td><td>K</td></tr> <tr><td>±20%</td><td>M</td></tr> </table>	Tolerance	Code	±2%	G	±3%	H	±5%	J	±10%	K	±20%	M	例/Example <table border="1" style="margin-left: auto; margin-right: auto;"> <thead> <tr><th>Code</th><th>Lead Style</th></tr> </thead> <tbody> <tr><td>T□</td><td>テーピング つづら折り Taping Ammo Pack</td></tr> <tr><td>(下表参照)</td><td>リードカット Lead Cut</td></tr> <tr><td>(See below table)</td><td>フォーミング リードカット Forming Lead Cut</td></tr> </tbody> </table>		Code	Lead Style	T□	テーピング つづら折り Taping Ammo Pack	(下表参照)	リードカット Lead Cut	(See below table)	フォーミング リードカット Forming Lead Cut
Tolerance	Code																									
±2%	G																									
±3%	H																									
±5%	J																									
±10%	K																									
±20%	M																									
Code	Lead Style																									
T□	テーピング つづら折り Taping Ammo Pack																									
(下表参照)	リードカット Lead Cut																									
(See below table)	フォーミング リードカット Forming Lead Cut																									

◆リードカット・フォーミングリードカット/LEAD CUT AND FORMING LEAD CUT

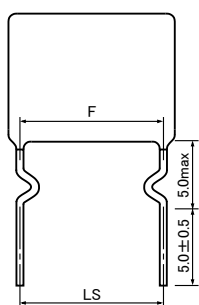
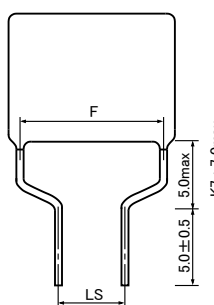
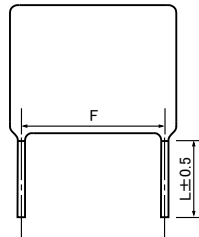
形状 Style	FORMING LEAD CUT							STRAIGHT LEAD CUT	
	E7 H7 Y7 X7 17 27	F=LS 	S7 W7 Q7 K7	F>LS 					
LS (mm)	5.0	7.5	10.0	15.0	20.0	22.5	27.5	カット長 L (mm)	記号 Code
F (mm)	7.5	10.0	15.0	20.0	22.5	27.5	3.5	4.0	4.5
	S7	E7	—	—	—	—	—	A1	A3
	10.0	S7	W7	H7	—	—	—	4.5	A5
	15.0	S7	W7	Q7	Y7	—	—	5.0	A7
	20.0	—	—	—	X7	—	—		
	22.5	—	—	—	K7	17	—		
	27.5	—	—	—	—	—	27		

- ・フォーミングリードは、5mm以外のカット長も対応可能ですのでご相談ください。
Other cut length is also available for forming lead, please consult our sales offices.
- ・フォーミング形状はこの他に各種ありますのでご相談ください。
Other forming style is also available, please consult our sales offices.
- ・「F2D」「P2S」「H2D」はストレートカット対象外です。テーピングのTSをご使用ください。
F2D, P2S and H2D series are not available for straight lead cut. Please use TS style of taping.

◆テーピング仕様/TAPING SPECIFICATIONS

◆寸法/DIMENSIONS

・フォーミングリードタイプ/ Formed Lead Type

・Style A.B.D

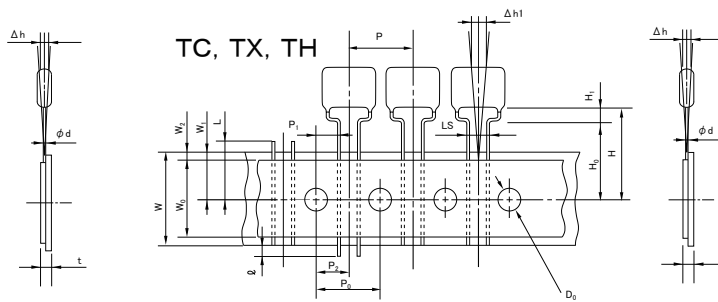
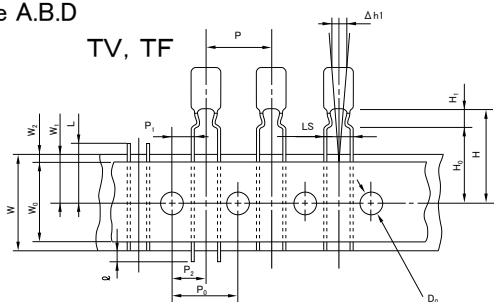

・Style C.E

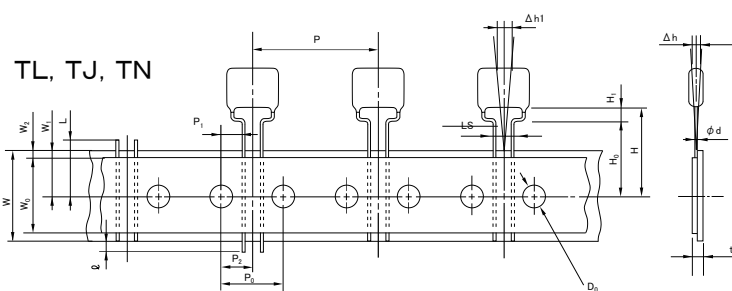

・ストレートリードタイプ/ Straight Lead Type

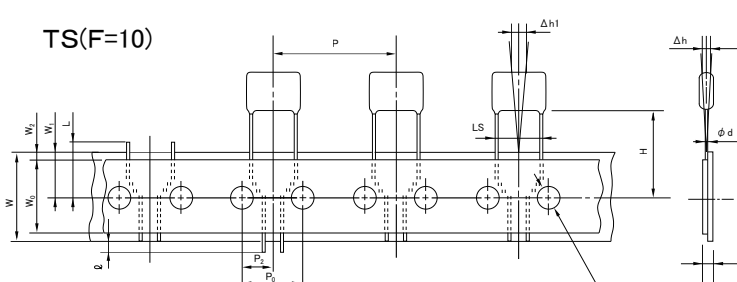
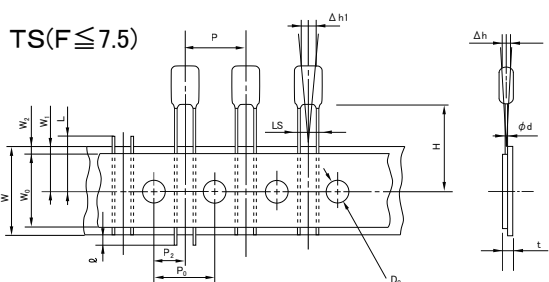

項目 Items	Style Symbol	フォーミングリードタイプ / Formed Lead Type							ストレートリードタイプ Straight Lead Type			
		Style A		Style B		Style C		Style D	Style E	Style S		
		TV	TC	TF	TX	TL	TJ	TH	TN	TS		
製品F寸法(mm) Original lead pitch		3.5~7.5	7.5	7.0~8.0	10.0	10.0~12.5	15.0	10.0	15.0~17.0	3.5~7.5	10.0	
P		12.7 ±1		15.0 ±1		25.4 ±1		15.0 ±1	30.0 ±1	12.7±0.1	25.4±1	
P0		12.7 ±0.2		15.0 ±0.2		12.7 ±0.2		15.0 ±0.2	15.0 ±0.2	12.7 ±0.2		
P1		3.85 ±0.5		5.0 ±0.5		3.85 ±0.5		3.75 ±0.5	3.75 ±0.5			
P2		6.35 ±0.5		7.5 ±0.5		6.35 ±0.5		7.5 ±0.5	7.5 ±0.5	6.35 ±0.5		
LS		5.0 ±0.8 -0.2		5.0 ±0.8 -0.2		5.0 ±0.8 -0.2		7.5 ±0.8 -0.2	7.5 ±0.8 -0.2	F		
W		18.0 ± 1.0 0.5		18.0 ± 1.0 0.5		18.0 ± 1.0 0.5		18.0 ± 1.0 0.5	18.0 ± 1.0 0.5	18.0 ± 1.0 0.5		
W0		5min		5min		5min		5min	5min	5min		
W1		9.0 ±0.5		9.0 ±0.5		9.0 ±0.5		9.0 ±0.5	9.0 ±0.5	9.0 ±0.5		
W2		3.0max		3.0max		3.0max		3.0max	3.0max	3.0max		
φd		0.5~0.8(個別製品ページ参照 individual page)										
H		20.0 ±0.75		20.0 ±0.75		20.0 ±0.75		20.0 ±0.75	20.0 ±0.75	20.0 ±0.75		
H0		16.0 ±0.5		16.0 ±0.5		16.0 ±0.5		16.0 ±0.5	16.0 ±0.5			
H1						5.0max						
D0		4.0 ±0.2		4.0 ±0.2		4.0 ±0.2		4.0 ±0.2	4.0 ±0.2	4.0 ±0.2		
L		11.0max		11.0max		11.0max		11.0max	11.0max	11.0max		
ℓ		0max		0max		0max		0max	0max	0max		
ΔH		0 ±1.0		0 ±1.0		0 ±1.0		0 ±1.0	0 ±1.0	0 ±1.0		
ΔH1		0 ±1.0		0 ±1.0		0 ±1.0		0 ±1.0	0 ±1.0	0 ±1.0		
t		φd+0.9max		φd+0.9max		φd+0.9max		φd+0.9max	φd+0.9max	φd+0.9max		

・これ以外の形状についてはご相談ください。 Please consult us about other styles.

MPB series

標準品 Standard

- ・インバータなどの高周波・大電流回路に最適です。
For applications where high frequency and high current are required. Standard (TV, display monitor, power supply, lighting Inverter, etc)
- ・外装に難燃性(UL94 V-0)のエポキシ樹脂を使用していますので、安全性に優れています。
Coated with flame-retardant (UL94 V-0) epoxy resin.



◆規格表/SPECIFICATION

項目 Item	特性 Characteristics
カテゴリ温度範囲 Category Temperature Range	-40~+105°C
定格電圧範囲 Rated Voltage Range(U _R)	250Vdc, 450Vdc, 630Vdc
静電容量許容差 Capacitance Tolerance	±5%(J)
誘電正接 tan δ	0.001max at 1kHz
耐電圧 Voltage Proof	U _R × 150% 60s
絶縁抵抗 Insulation Resistance	C ≤ 0.33 μF: 25000M Ω min C > 0.33 μF: 7500 Ω Fmin
準拠規格 Reference Standard	JIS C 5101-16, JIS C 5101-1

◆呼称方法/PART NUMBER



◆寸法図/DIMENSIONS

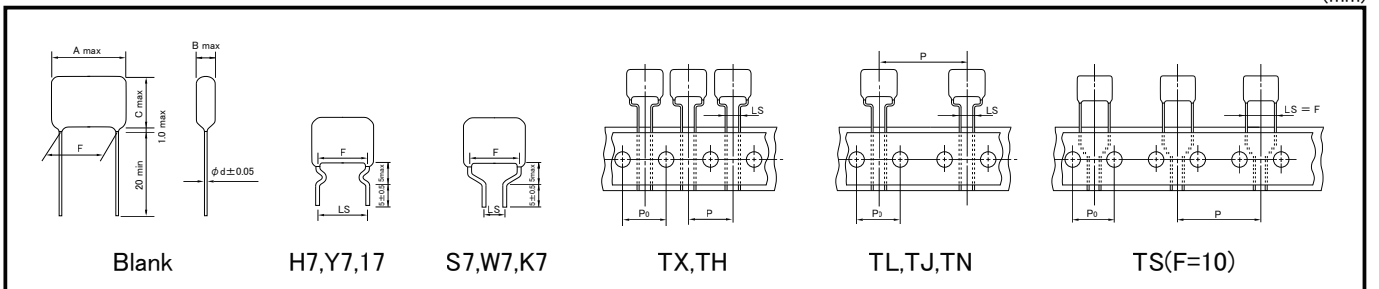

◆周波数に対する許容電流/PERMISSIBLE CURRENT FOR FREQUENCY

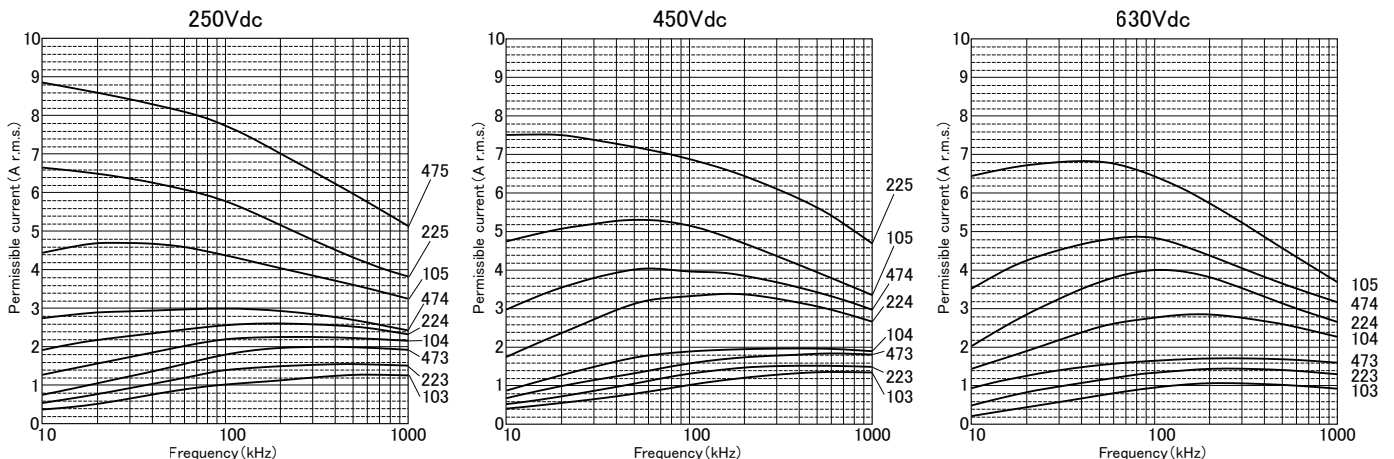

MPK series

小形化品 Miniaturized

- ・実装高さを抑えた小形低背品です。
Miniaturized, Low height.
- ・コンデンサから発生するうなり音を低減しました。 Low buzz.
- ・外装に難燃性 (UL94 V-0) のエポキシ樹脂を使用していますので、
安全性に優れています。
Coated with flame-retardant (UL94 V-0) epoxy resin.

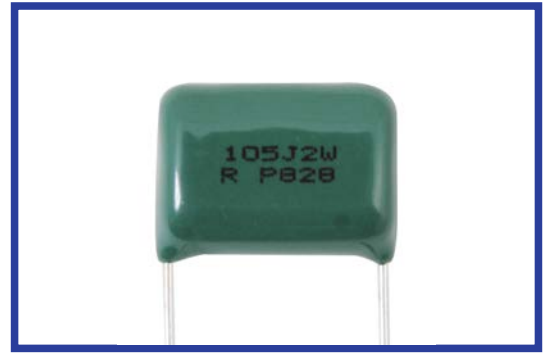

◆規格表 / SPECIFICATION

項目 Item	特性 Characteristics
カテゴリ温度範囲 Category Temperature Range	-40~+105°C ※
定格電圧範囲 Rated Voltage Range(U _R)	450Vdc, 630Vdc, 800Vdc
静電容量許容差 Capacitance Tolerance	±5%(J)
誘電正接 tan δ	0.001max at 1kHz
耐電圧 Voltage Proof	U _R × 150% 60s
絶縁抵抗 Insulation Resistance	C ≤ 0.33 μF: 25000M Ω min C > 0.33 μF: 7500 Ω Fmin
準拠規格 Reference Standard	JIS C 5101-16, JIS C 5101-1

※85°Cを超える範囲では使用上の注意事項に示す電圧軽減を行ってください。
Derate the voltage as shown CAUTION FOR PROPER USE OF FILM CAPACITORS when using the capacitor beyond 85°C

◆呼称方法 / PART NUMBER



◆寸法図 / DIMENSIONS

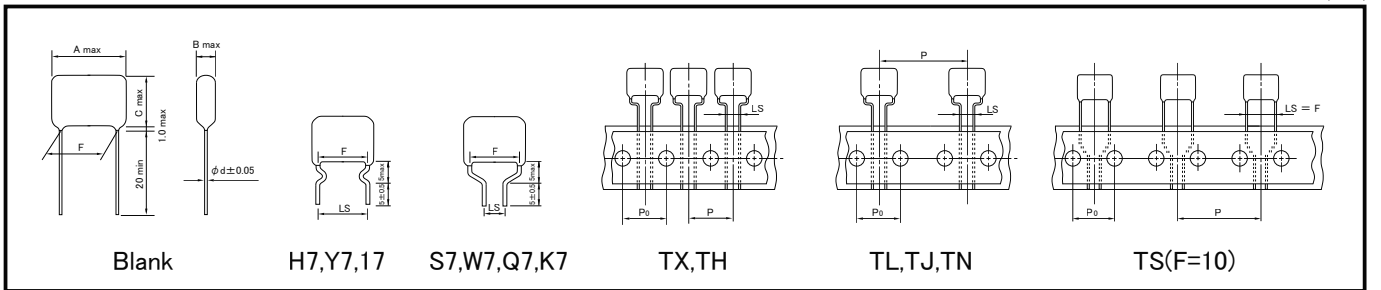

◆周波数に対する許容電流 / PERMISSIBLE CURRENT FOR FREQUENCY

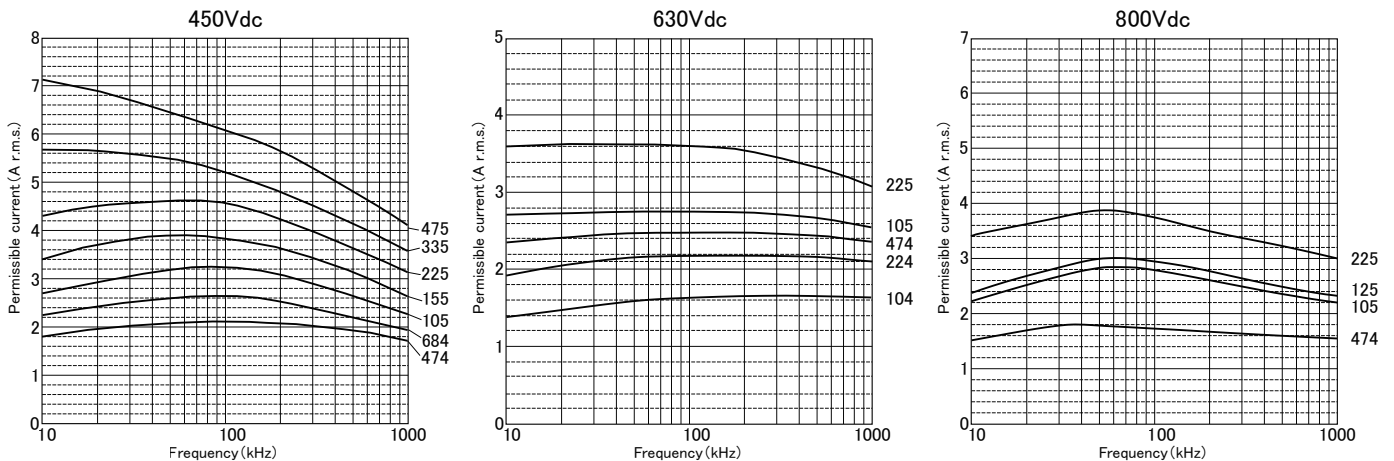

◆標準品一覧表/STANDARD SIZE

**：リード加工記号/Lead Forming

定格電圧 Rated Voltage (Vdc)	静電容量 Capacitance (μ F)	寸法 Dimensions (mm)						標準梱包数/Typical Packaging Quantity (pcs)							品番 Part No
		A	B	C	F \pm 1.0	LS \pm 0.5	d	ロングリード品 Long Lead type		テーピング(つづら)品 - 形状別 Taping Ammo Pack Type - Style					
								Bag	Carton	TC	TX,TH	TL,TJ	TN	TS	
450	0.47	18.0	6.5	11.0	15.0	5.0/7.5/10.0/15.0	0.6	100	2,000	-	-	500	400	-	450MPK474J**
	0.56	18.0	7.0	11.5	15.0	5.0/7.5/10.0/15.0	0.6	100	2,000	-	-	500	400	-	450MPK564J**
	0.68	18.0	8.0	12.5	15.0	5.0/7.5/10.0/15.0	0.6	100	2,000	-	-	400	400	-	450MPK684J**
	0.82	18.0	8.5	13.0	15.0	5.0/7.5/10.0/15.0	0.8	100	2,000	-	-	400	300	-	450MPK824J**
	1	18.0	9.5	14.0	15.0	5.0/7.5/10.0/15.0	0.8	100	1,000	-	-	400	300	-	450MPK105J**
	1.2	18.0	10.0	15.0	15.0	5.0/7.5/10.0/15.0	0.8	100	1,000	-	-	-	-	-	450MPK125J**
	1.5	18.0	11.0	16.0	15.0	5.0/7.5/10.0/15.0	0.8	200	1,000	-	-	-	-	-	450MPK155J**
	1.8	18.0	13.0	17.0	15.0	5.0/7.5/10.0/15.0	0.8	200	1,000	-	-	-	-	-	450MPK185J**
	2.2	18.0	13.5	19.0	15.0	5.0/7.5/10.0/15.0	0.8	200	1,000	-	-	-	-	-	450MPK225J**
	2.7	18.0	14.5	21.0	15.0	5.0/7.5/10.0/15.0	0.8	200	800	-	-	-	-	-	450MPK275J**
	3.3	18.0	16.0	22.5	15.0	5.0/7.5/10.0/15.0	1.0	100	500	-	-	-	-	-	450MPK335J**
	3.9	18.0	17.0	23.5	15.0	5.0/7.5/10.0/15.0	1.0	100	500	-	-	-	-	-	450MPK395J**
4.7	18.0	19.0	25.5	15.0	5.0/7.5/10.0/15.0	1.0	100	500	-	-	-	-	-	450MPK475J**	
630	0.1	13.0	8.0	13.0	10.0	5.0/7.5/10.0	0.6	100	2,000	-	500	400	-	400	630MPK104J**
	0.12	13.0	8.5	13.5	10.0	5.0/7.5/10.0	0.6	100	2,000	-	500	400	-	400	630MPK124J**
	0.15	13.0	9.0	14.5	10.0	5.0/7.5/10.0	0.6	100	2,000	-	500	400	-	400	630MPK154J**
	0.18	13.0	9.5	15.0	10.0	5.0/7.5/10.0	0.6	100	2,000	-	500	300	-	300	630MPK184J**
	0.22	13.0	10.5	15.5	10.0	5.0/7.5/10.0	0.6	100	2,000	-	500	300	-	300	630MPK224J**
	0.27	18.0	7.5	13.0	15.0	5.0/7.5/10.0/15.0	0.8	100	2,000	-	-	400	400	-	630MPK274J**
	0.33	18.0	8.0	13.5	15.0	5.0/7.5/10.0/15.0	0.8	100	1,000	-	-	400	300	-	630MPK334J**
	0.39	18.0	8.5	14.5	15.0	5.0/7.5/10.0/15.0	0.8	100	1,000	-	-	400	300	-	630MPK394J**
	0.47	18.0	9.5	15.5	15.0	5.0/7.5/10.0/15.0	0.8	100	1,000	-	-	300	300	-	630MPK474J**
	0.56	18.0	9.5	17.0	15.0	5.0/7.5/10.0/15.0	0.8	200	1,000	-	-	300	300	-	630MPK564J**
	0.68	18.0	10.5	18.5	15.0	5.0/7.5/10.0/15.0	0.8	200	1,000	-	-	300	-	-	630MPK684J**
	0.82	25.5	9.0	16.5	22.5	15.0/22.5	0.8	200	1,000	-	-	-	-	-	630MPK824J**
	1	25.5	10.0	17.0	22.5	15.0/22.5	0.8	200	1,000	-	-	-	-	-	630MPK105J**
	1.2	25.5	10.5	19.0	22.5	15.0/22.5	0.8	200	800	-	-	-	-	-	630MPK125J**
1.5	25.5	11.0	20.0	22.5	15.0/22.5	0.8	100	500	-	-	-	-	-	630MPK155J**	
1.8	25.5	12.0	21.0	22.5	15.0/22.5	0.8	100	500	-	-	-	-	-	630MPK185J**	
2.2	25.5	13.0	23.0	22.5	15.0/22.5	0.8	100	500	-	-	-	-	-	630MPK225J**	
800	0.47	26.5	10.0	17.5	22.5	15.0/22.5	0.8	200	800	-	-	-	-	-	800MPK474J**
	0.56	26.5	10.5	18.0	22.5	15.0/22.5	0.8	200	800	-	-	-	-	-	800MPK564J**
	0.68	26.5	11.5	19.0	22.5	15.0/22.5	0.8	100	500	-	-	-	-	-	800MPK684J**
	0.82	26.5	13.0	20.0	22.5	15.0/22.5	0.8	100	500	-	-	-	-	-	800MPK824J**
	1	26.5	14.0	21.5	22.5	15.0/22.5	1.0	100	500	-	-	-	-	-	800MPK105J**
	1.2	31.5	13.0	22.0	27.5	-	1.0	100	400	-	-	-	-	-	800MPK125J**
	1.5	31.5	14.5	23.5	27.5	-	1.0	50	400	-	-	-	-	-	800MPK155J**
	1.8	31.5	16.0	25.0	27.5	-	1.0	50	300	-	-	-	-	-	800MPK185J**
2.2	31.5	17.5	26.5	27.5	-	1.0	50	300	-	-	-	-	-	800MPK225J**	

MPN series

超小形化品 Ultra Miniaturized

- ・内部保安機構付きで安全性を高めています。
Safety construction.
- ・外装に難燃性 (UL94 V-0) のエポキシ樹脂を使用していますので、
安全性に優れています。
Coated with flame-retardant (UL94 V-0) epoxy resin.



◆規格表 / SPECIFICATION

項目 Item	特性 Characteristics
カテゴリ温度範囲 Category Temperature Range	-40 ~ +85°C
定格電圧範囲 Rated Voltage Range (U _R)	450Vdc, 630Vdc
静電容量許容差 Capacitance Tolerance	±5%(J)
誘電正接 tan δ	0.001max at 1kHz
耐電圧 Voltage Proof	U _R × 150% 60s
絶縁抵抗 Insulation Resistance	C ≤ 0.33 μF: 25000M Ω min C > 0.33 μF: 7500 Ω Fmin
準拠規格 Reference Standard	JIS C 5101-16, JIS C 5101-1

◆呼称方法 / PART NUMBER



◆寸法図 / DIMENSIONS

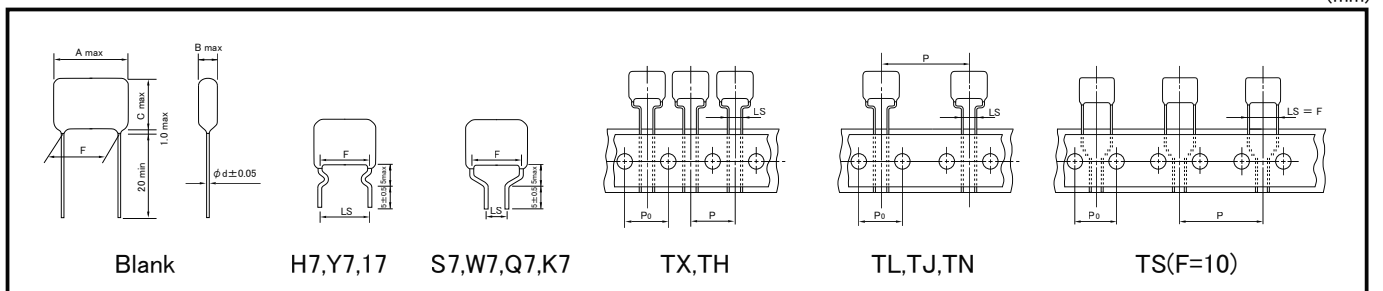

◆周波数に対する許容電流 / PERMISSIBLE CURRENT FOR FREQUENCY

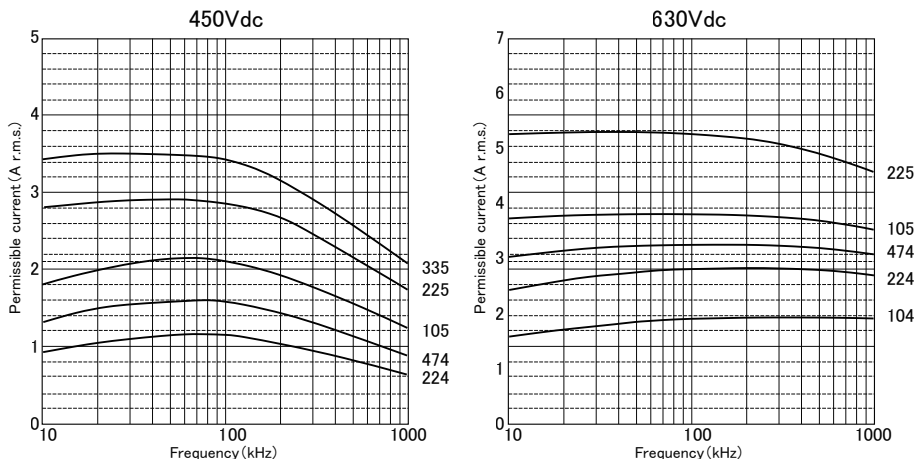

◆標準品一覧表/STANDARD SIZE

**：リード加工記号/Lead Forming

定格電圧 Rated Voltage (Vdc)	静電容量 Capacitance (μ F)	寸法 Dimensions (mm)						標準梱包数/Typical Packaging Quantity (pcs)							品番 Part No
		A	B	C	F \pm 1.0	LS \pm 0.5	d	ロングリード品 Long Lead type		テーピング(つづら)品 - 形状別 Taping Ammo Pack Type - Style					
								Bag	Carton	TC	TX,TH	TL,TJ	TN	TS	
450	0.22	13.5	6.5	11.0	10.0	5.0/7.5/10.0	0.6	200	3,000	-	500	500	-	500	450MPN224J**
	0.27	13.5	7.0	11.5	10.0	5.0/7.5/10.0	0.6	100	3,000	-	500	500	-	500	450MPN274J**
	0.33	13.5	7.5	12.5	10.0	5.0/7.5/10.0	0.6	100	2,000	-	500	400	-	400	450MPN334J**
	0.39	13.5	8.0	13.5	10.0	5.0/7.5/10.0	0.6	100	2,000	-	500	400	-	400	450MPN394J**
	0.47	13.5	8.0	15.0	10.0	5.0/7.5/10.0	0.6	100	2,000	-	500	400	-	400	450MPN474J**
	0.56	18.5	6.5	11.0	15.0	5.0/7.5/10.0/15.0	0.6	100	2,000	-	-	500	400	-	450MPN564J**
	0.68	18.5	7.0	11.5	15.0	5.0/7.5/10.0/15.0	0.6	100	2,000	-	-	500	400	-	450MPN684J**
	0.82	18.5	7.5	12.0	15.0	5.0/7.5/10.0/15.0	0.8	100	2,000	-	-	400	400	-	450MPN824J**
	1	18.5	8.0	12.5	15.0	5.0/7.5/10.0/15.0	0.8	100	2,000	-	-	400	300	-	450MPN105J**
	1.2	18.5	9.0	13.0	15.0	5.0/7.5/10.0/15.0	0.8	100	1,000	-	-	400	300	-	450MPN125J**
	1.5	18.5	10.0	13.5	15.0	5.0/7.5/10.0/15.0	0.8	100	1,000	-	-	-	-	-	450MPN155J**
	1.8	18.5	10.5	14.5	15.0	5.0/7.5/10.0/15.0	0.8	200	1,000	-	-	-	-	-	450MPN185J**
	2.2	18.5	11.0	16.0	15.0	5.0/7.5/10.0/15.0	0.8	200	1,000	-	-	-	-	-	450MPN225J**
	2.7	18.5	12.0	17.0	15.0	5.0/7.5/10.0/15.0	0.8	200	1,000	-	-	-	-	-	450MPN275J**
	3.3	18.5	13.0	18.0	15.0	5.0/7.5/10.0/15.0	0.8	200	800	-	-	-	-	-	450MPN335J**
3.9	18.5	14.0	19.5	15.0	5.0/7.5/10.0/15.0	0.8	200	800	-	-	-	-	-	450MPN395J**	
4.7	18.5	15.5	21.0	15.0	5.0/7.5/10.0/15.0	0.8	100	500	-	-	-	-	-	450MPN475J**	
630	0.1	13.5	6.5	12.0	10.0	5.0/7.5/10.0	0.6	100	3,000	-	500	500	-	500	630MPN104J**
	0.12	13.5	7.0	12.5	10.0	5.0/7.5/10.0	0.6	100	2,000	-	500	500	-	500	630MPN124J**
	0.15	13.5	7.5	14.0	10.0	5.0/7.5/10.0	0.6	100	2,000	-	500	400	-	400	630MPN154J**
	0.18	13.5	8.0	14.5	10.0	5.0/7.5/10.0	0.6	100	2,000	-	500	400	-	400	630MPN184J**
	0.22	13.5	8.5	15.5	10.0	5.0/7.5/10.0	0.8	100	2,000	-	500	400	-	400	630MPN224J**
	0.27	18.0	7.0	14.0	15.0	5.0/7.5/10.0/15.0	0.8	100	2,000	-	-	500	400	-	630MPN274J**
	0.33	18.0	7.5	14.5	15.0	5.0/7.5/10.0/15.0	0.8	100	2,000	-	-	400	400	-	630MPN334J**
	0.39	18.0	8.5	15.0	15.0	5.0/7.5/10.0/15.0	0.8	100	1,000	-	-	400	300	-	630MPN394J**
	0.47	18.0	9.0	16.0	15.0	5.0/7.5/10.0/15.0	0.8	100	1,000	-	-	-	-	-	630MPN474J**
	0.56	18.0	9.0	17.5	15.0	5.0/7.5/10.0/15.0	0.8	200	1,000	-	-	-	-	-	630MPN564J**
	0.68	18.0	10.0	18.5	15.0	5.0/7.5/10.0/15.0	0.8	200	1,000	-	-	-	-	-	630MPN684J**
	0.82	25.5	8.5	17.0	22.5	15.0/22.5	0.8	200	1,000	-	-	-	-	-	630MPN824J**
	1	25.5	9.5	18.0	22.5	15.0/22.5	0.8	200	800	-	-	-	-	-	630MPN105J**
	1.2	25.5	10.5	19.0	22.5	15.0/22.5	0.8	200	800	-	-	-	-	-	630MPN125J**
	1.5	25.5	11.5	20.0	22.5	15.0/22.5	0.8	100	500	-	-	-	-	-	630MPN155J**
1.8	25.5	12.5	21.0	22.5	15.0/22.5	0.8	100	500	-	-	-	-	-	630MPN185J**	
2.2	25.5	14.0	22.5	22.5	15.0/22.5	0.8	100	500	-	-	-	-	-	630MPN225J**	

MPH series

低損失 低ESR品 Low D.F, Low ESR

- ・縦長形状で小形化、低ESR化したシリーズです。
Miniaturized and Low ESR with vertically long shape.
- ・コンデンサから発生するうなり音を低減しました。 Low buzz.
- ・外装に難燃性 (UL94 V-0) のエポキシ樹脂を使用していますので、安全性に優れています。
Coated with flame-retardant (UL94 V-0) epoxy resin.



◆規格表/SPECIFICATION

項目 Item	特性 Characteristics
カテゴリ温度範囲 Category Temperature Range	-40~+105°C
定格電圧範囲 Rated Voltage Range(U _R)	100Vdc, 250Vdc, 450Vdc, 630Vdc, 800Vdc
静電容量許容差 Capacitance Tolerance	±5%(J)
誘電正接 tan δ	0.001max at 1kHz
耐電圧 Voltage Proof	U _R × 150% 60s
絶縁抵抗 Insulation Resistance	C ≤ 0.33 μF: 25000M Ω min C > 0.33 μF: 7500 Ω Fmin
準拠規格 Reference Standard	JIS C 5101-16, JIS C 5101-1

◆呼称方法/PART NUMBER



◆寸法図/DIMENSIONS

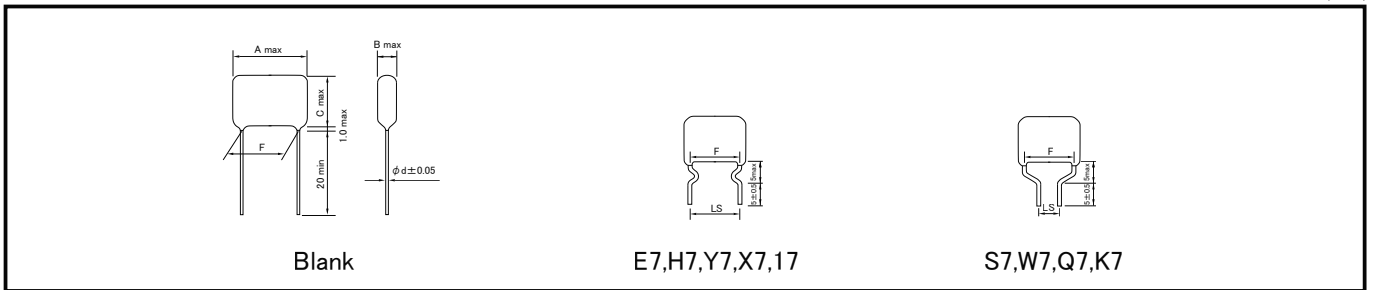

◆周波数に対する許容電流/PERMISSIBLE CURRENT FOR FREQUENCY

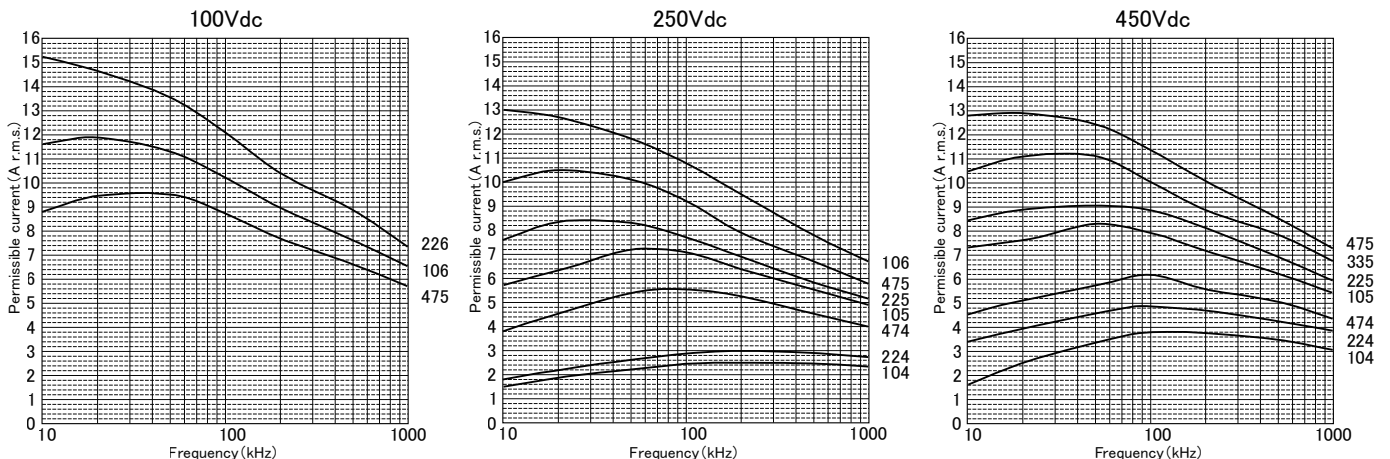

◆標準品一覧表/STANDARD SIZE

**：リード加工記号/Lead Forming

定格電圧 Rated Voltage (Vdc)	静電容量 Capacitance (μ F)	寸法 Dimensions (mm)						標準梱包数/Typical Packaging Quantity (pcs)							品番 Part No
		A	B	C	F \pm 1.0	LS \pm 0.5	d	ロングリード品 Long Lead type		テーピング(つづら)品 - 形状別 Taping Ammo Pack Type - Style					
								Bag	Carton	TC	TX,TH	TL,TJ	TN	TS	
100	4.7	18.5	13.5	24.0	15.0	7.5/10.0/15.0	1.0	100	500	-	-	-	-	-	100MPH475J**
	5.6	18.5	14.5	25.0	15.0	7.5/10.0/15.0	1.0	100	500	-	-	-	-	-	100MPH565J**
	6.8	18.5	16.0	26.5	15.0	7.5/10.0/15.0	1.0	100	500	-	-	-	-	-	100MPH685J**
	8.2	18.5	18.0	28.0	15.0	7.5/10.0/15.0	1.0	100	500	-	-	-	-	-	100MPH825J**
	10	18.5	20.0	30.0	15.0	7.5/10.0/15.0	1.0	100	400	-	-	-	-	-	100MPH106J**
	12	26.5	17.0	27.5	22.5	15.0/22.5	1.0	100	300	-	-	-	-	-	100MPH126J**
	15	26.5	19.0	29.5	22.5	15.0/22.5	1.0	100	300	-	-	-	-	-	100MPH156J**
	18	26.5	21.0	31.5	22.5	15.0/22.5	1.0	50	200	-	-	-	-	-	100MPH186J**
250	0.1	10.5	7.0	13.5	7.5	5.0/7.5	0.6	100	3,000	-	-	-	-	-	250MPH104J**
	0.12	10.5	8.0	14.0	7.5	5.0/7.5	0.6	100	2,000	-	-	-	-	-	250MPH124J**
	0.15	10.5	8.5	15.0	7.5	5.0/7.5	0.6	100	2,000	-	-	-	-	-	250MPH154J**
	0.18	10.5	9.0	15.5	7.5	5.0/7.5	0.6	100	2,000	-	-	-	-	-	250MPH184J**
	0.22	10.5	8.5	14.5	7.5	5.0/7.5	0.6	100	2,000	-	-	-	-	-	250MPH224J**
	0.27	10.5	8.5	16.5	7.5	5.0/7.5	0.6	100	2,000	-	-	-	-	-	250MPH274J**
	0.33	10.5	9.0	17.0	7.5	5.0/7.5	0.6	100	1,000	-	-	-	-	-	250MPH334J**
	0.39	13.0	8.0	16.0	10.0	5.0/7.5/10.0	0.6	100	2,000	-	-	-	-	-	250MPH394J**
	0.47	13.0	9.0	17.0	10.0	5.0/7.5/10.0	0.8	100	1,000	-	-	-	-	-	250MPH474J**
	0.56	13.0	10.0	18.0	10.0	5.0/7.5/10.0	0.8	200	1,000	-	-	-	-	-	250MPH564J**
	0.68	13.0	11.0	19.0	10.0	5.0/7.5/10.0	0.8	200	1,000	-	-	-	-	-	250MPH684J**
	0.82	13.0	12.0	20.0	10.0	5.0/7.5/10.0	0.8	200	1,000	-	-	-	-	-	250MPH824J**
	1	13.0	13.0	21.0	10.0	5.0/7.5/10.0	0.8	200	1,000	-	-	-	-	-	250MPH105J**
	1.2	13.0	14.5	22.0	10.0	5.0/7.5/10.0	0.8	200	800	-	-	-	-	-	250MPH125J**
	1.5	13.0	15.0	24.0	10.0	5.0/7.5/10.0	0.8	200	800	-	-	-	-	-	250MPH155J**
	1.8	18.5	13.0	20.5	15.0	7.5/10.0/15.0	0.8	200	800	-	-	-	-	-	250MPH185J**
	2.2	18.5	14.0	21.5	15.0	7.5/10.0/15.0	0.8	100	500	-	-	-	-	-	250MPH225J**
	2.7	18.5	16.0	23.5	15.0	7.5/10.0/15.0	1.0	100	500	-	-	-	-	-	250MPH275J**
	3.3	18.5	17.0	26.5	15.0	7.5/10.0/15.0	1.0	100	500	-	-	-	-	-	250MPH335J**
	3.9	18.5	18.5	28.0	15.0	7.5/10.0/15.0	1.0	100	500	-	-	-	-	-	250MPH395J**
4.7	18.5	20.5	29.5	15.0	7.5/10.0/15.0	1.0	100	500	-	-	-	-	-	250MPH475J**	
5.6	23.5	18.5	28.0	20.0	20.0	1.0	100	400	-	-	-	-	-	250MPH565J**	
6.8	23.5	19.5	30.0	20.0	20.0	1.0	100	300	-	-	-	-	-	250MPH685J**	
8.2	23.5	22.0	32.5	20.0	20.0	1.0	100	300	-	-	-	-	-	250MPH825J**	
10	23.5	24.5	33.5	20.0	20.0	1.0	100	300	-	-	-	-	-	250MPH106J**	

◆周波数に対する許容電流/PERMISSIBLE CURRENT FOR FREQUENCY

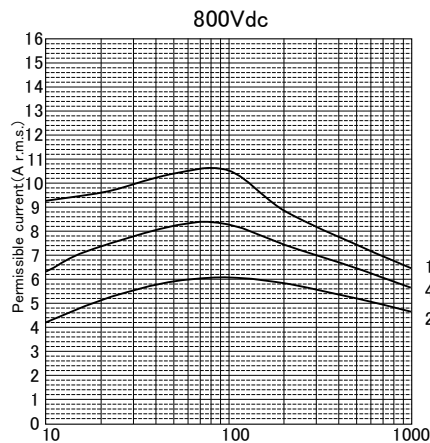
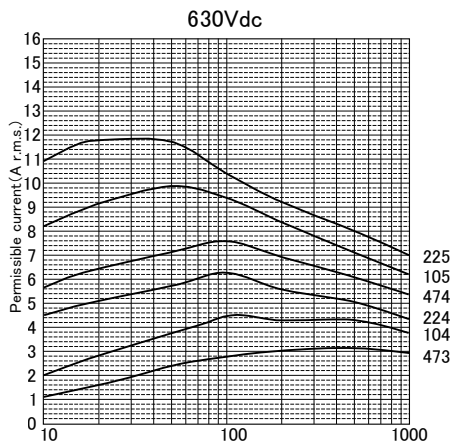

◆標準品一覧表/STANDARD SIZE

**：リード加工記号/Lead Forming

定格電圧 Rated Voltage (Vdc)	静電容量 Capacitance (μ F)	寸法 Dimensions (mm)						標準梱包数/Typical Packaging Quantity (pcs)							品番 Part No
		A	B	C	F \pm 1.0	LS \pm 0.5	d	ロングリード品 Long Lead type		テーピング(つづら)品 - 形状別 Taping Ammo Pack Type - Style					
								Bag	Carton	TC	TX,TH	TL,TJ	TN	TS	
450	0.1	10.5	8.5	14.5	7.5	5.0/7.5	0.8	100	2,000	-	-	-	-	-	450MPH104J**
	0.12	10.5	9.5	15.5	7.5	5.0/7.5	0.8	100	2,000	-	-	-	-	-	450MPH124J**
	0.15	13.0	8.5	14.5	10.0	5.0/7.5/10.0	0.8	100	2,000	-	-	-	-	-	450MPH154J**
	0.18	13.0	9.0	15.0	10.0	5.0/7.5/10.0	0.8	100	2,000	-	-	-	-	-	450MPH184J**
	0.22	13.0	9.5	16.0	10.0	5.0/7.5/10.0	0.8	100	1,000	-	-	-	-	-	450MPH224J**
	0.27	13.0	10.5	18.0	10.0	5.0/7.5/10.0	0.8	200	1,000	-	-	-	-	-	450MPH274J**
	0.33	13.0	11.5	19.0	10.0	5.0/7.5/10.0	0.8	200	1,000	-	-	-	-	-	450MPH334J**
	0.39	13.0	12.5	19.5	10.0	5.0/7.5/10.0	0.8	200	1,000	-	-	-	-	-	450MPH394J**
	0.47	13.0	13.5	21.0	10.0	5.0/7.5/10.0	0.8	200	1,000	-	-	-	-	-	450MPH474J**
	0.56	18.5	11.0	18.5	15.0	7.5/10.0/15.0	0.8	200	1,000	-	-	-	-	-	450MPH564J**
	0.68	18.5	12.5	19.5	15.0	7.5/10.0/15.0	0.8	200	800	-	-	-	-	-	450MPH684J**
	0.82	18.5	13.5	20.5	15.0	7.5/10.0/15.0	0.8	200	800	-	-	-	-	-	450MPH824J**
	1	18.5	15.0	22.0	15.0	7.5/10.0/15.0	1.0	100	500	-	-	-	-	-	450MPH105J**
	1.2	18.5	15.5	24.0	15.0	7.5/10.0/15.0	1.0	100	500	-	-	-	-	-	450MPH125J**
	1.5	18.5	17.5	26.0	15.0	7.5/10.0/15.0	1.0	100	500	-	-	-	-	-	450MPH155J**
	1.8	18.5	19.0	27.5	15.0	7.5/10.0/15.0	1.0	100	500	-	-	-	-	-	450MPH185J**
	2.2	18.5	21.0	30.5	15.0	7.5/10.0/15.0	1.0	100	400	-	-	-	-	-	450MPH225J**
	2.7	23.5	19.0	29.0	20.0	20.0	1.0	100	400	-	-	-	-	-	450MPH275J**
3.3	23.5	21.0	32.0	20.0	20.0	1.0	100	300	-	-	-	-	-	450MPH335J**	
3.9	23.5	23.0	34.0	20.0	20.0	1.0	100	300	-	-	-	-	-	450MPH395J**	
4.7	23.5	25.0	36.0	20.0	20.0	1.0	50	200	-	-	-	-	-	450MPH475J**	
630	0.047	13.0	8.5	14.0	10.0	5.0/7.5/10.0	0.8	100	2,000	-	-	-	-	-	630MPH473J**
	0.056	13.0	9.0	15.0	10.0	5.0/7.5/10.0	0.8	100	2,000	-	-	-	-	-	630MPH563J**
	0.068	13.0	10.0	15.5	10.0	5.0/7.5/10.0	0.8	100	1,000	-	-	-	-	-	630MPH683J**
	0.082	13.0	10.5	16.5	10.0	5.0/7.5/10.0	0.8	100	1,000	-	-	-	-	-	630MPH823J**
	0.1	13.0	11.0	17.0	10.0	5.0/7.5/10.0	0.8	200	1,000	-	-	-	-	-	630MPH104J**
	0.12	13.0	12.0	17.5	10.0	5.0/7.5/10.0	0.8	200	1,000	-	-	-	-	-	630MPH124J**
	0.15	13.0	13.0	19.0	10.0	5.0/7.5/10.0	0.8	200	1,000	-	-	-	-	-	630MPH154J**
	0.18	13.0	14.5	20.0	10.0	5.0/7.5/10.0	0.8	200	1,000	-	-	-	-	-	630MPH184J**
	0.22	13.0	15.5	21.0	10.0	5.0/7.5/10.0	0.8	200	800	-	-	-	-	-	630MPH224J**
	0.27	18.5	12.0	19.5	15.0	7.5/10.0/15.0	0.8	200	800	-	-	-	-	-	630MPH274J**
	0.33	18.5	13.5	20.5	15.0	7.5/10.0/15.0	0.8	200	800	-	-	-	-	-	630MPH334J**
	0.39	18.5	14.5	22.0	15.0	7.5/10.0/15.0	0.8	100	500	-	-	-	-	-	630MPH394J**
	0.47	18.5	16.0	23.0	15.0	7.5/10.0/15.0	1.0	100	500	-	-	-	-	-	630MPH474J**
	0.56	18.5	17.0	24.5	15.0	7.5/10.0/15.0	1.0	100	500	-	-	-	-	-	630MPH564J**
	0.68	18.5	18.0	27.0	15.0	7.5/10.0/15.0	1.0	100	500	-	-	-	-	-	630MPH684J**
	0.82	18.5	20.0	29.0	15.0	7.5/10.0/15.0	1.0	100	500	-	-	-	-	-	630MPH824J**
	1	18.5	21.5	32.0	15.0	7.5/10.0/15.0	1.0	100	400	-	-	-	-	-	630MPH105J**
	1.2	23.5	19.5	30.0	20.0	20.0	1.0	100	400	-	-	-	-	-	630MPH125J**
1.5	23.5	22.0	33.0	20.0	20.0	1.0	100	300	-	-	-	-	-	630MPH155J**	
1.8	23.5	24.0	34.0	20.0	20.0	1.0	50	200	-	-	-	-	-	630MPH185J**	
2.2	23.5	26.5	37.0	20.0	20.0	1.0	50	200	-	-	-	-	-	630MPH225J**	
800	0.22	18.5	15.5	23.0	15.0	7.5/10.0/15.0	1.0	100	500	-	-	-	-	-	800MPH224J**
	0.27	18.5	17.0	24.5	15.0	7.5/10.0/15.0	1.0	100	500	-	-	-	-	-	800MPH274J**
	0.33	18.5	19.0	26.5	15.0	7.5/10.0/15.0	1.0	100	500	-	-	-	-	-	800MPH334J**
	0.39	18.5	20.5	28.0	15.0	7.5/10.0/15.0	1.0	100	500	-	-	-	-	-	800MPH394J**
	0.47	18.5	21.5	30.5	15.0	7.5/10.0/15.0	1.0	100	400	-	-	-	-	-	800MPH474J**
	0.56	18.5	23.5	32.5	15.0	7.5/10.0/15.0	1.0	100	300	-	-	-	-	-	800MPH564J**
	0.68	26.5	19.5	28.5	22.5	15.0/22.5	1.0	50	200	-	-	-	-	-	800MPH684J**
	0.82	26.5	22.0	31.0	22.5	15.0/22.5	1.0	50	200	-	-	-	-	-	800MPH824J**
1	26.5	24.5	33.0	22.5	15.0/22.5	1.0	50	200	-	-	-	-	-	800MPH105J**	

MPE series

高電圧品 High Voltage

- ・特殊電極構造によりコロナ放電特性をアップしたシリーズです。
Up the corona discharge characteristics by special electrode construction.
- ・照明用電子バラストなどの高周波・高電圧回路に最適です。
- ・外装に難燃性 (UL94 V-0) のエポキシ樹脂を使用していますので、安全性に優れています。
Coated with flame-retardant (UL94 V-0) epoxy resin.



◆規格表/SPECIFICATION

項目 Item	特性 Characteristics
カテゴリ温度範囲 Category Temperature Range	-40~+105°C
定格電圧範囲 Rated Voltage Range(U _R)	800Vdc/250Vac, 1250Vdc/400Vac, 1600Vdc/700Vac
静電容量許容差 Capacitance Tolerance	±5%(J)
誘電正接 tan δ	0.001max at 1kHz
耐電圧 Voltage Proof	U _R × 150% 60s
絶縁抵抗 Insulation Resistance	30000M Ω min
準拠規格 Reference Standard	JIS C 5101-17, JIS C 5101-1

◆呼称方法/PART NUMBER

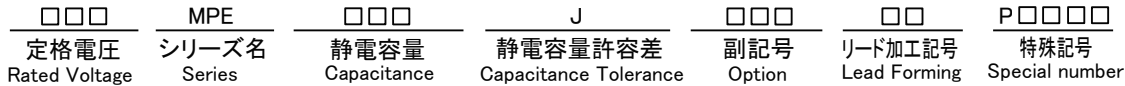

◆寸法図/DIMENSIONS

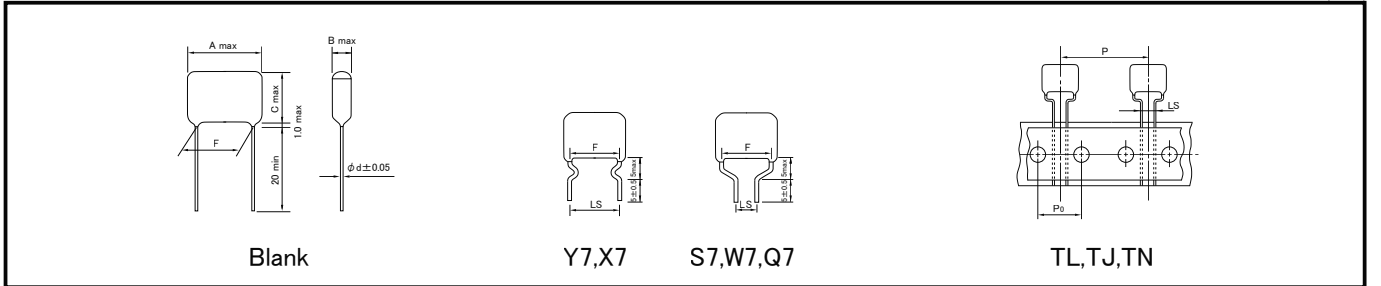

◆周波数に対する許容電流/PERMISSIBLE CURRENT FOR FREQUENCY

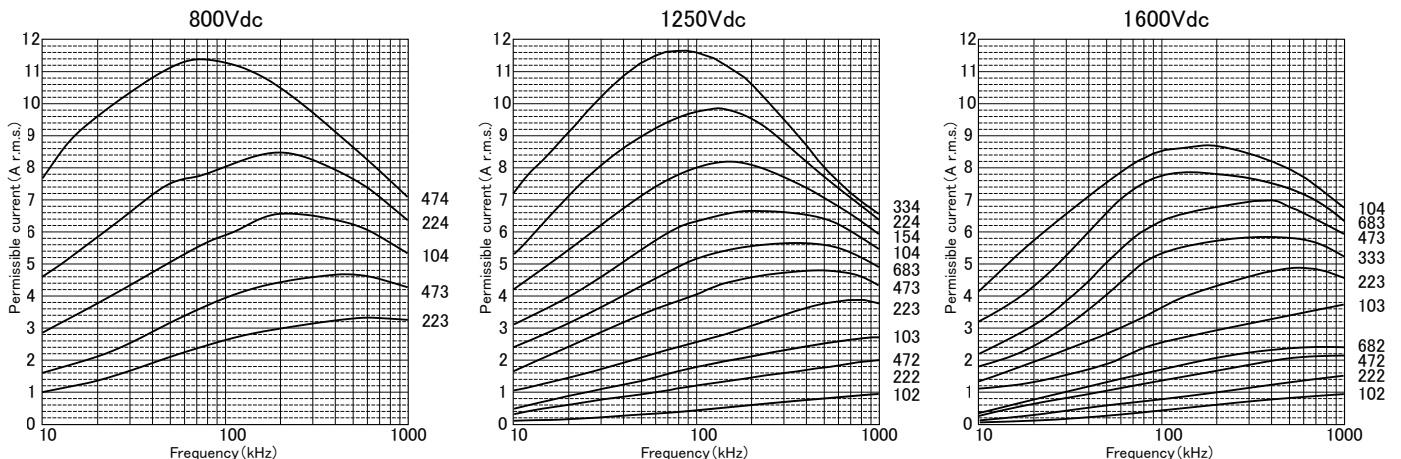

◆標準品一覧表/STANDARD SIZE

**：リード加工記号/Lead Forming

定格電圧 Rated Voltage	静電容量 Capacitance (μ F)	寸法 Dimensions (mm)						標準梱包数/Typical Packaging Quantity (pcs)							品番 Part No
		A	B	C	F \pm 1.0	LS \pm 0.5	d	ロングリード品 Long Lead type		テーピング(つづら)品 - 形状別 Taping Ammo Pack Type - Style					
								Bag	Carton	TC	TX,TH	TL,TJ	TN	TS	
800Vdc / 250Vac	0.001	この範囲はMPEシリーズ(1600Vdc)をご使用ください The item of this range, please select out of MPE(1600Vdc) series.													
	0.0012														
	0.0015														
	0.0018														
	0.0022														
	0.0027														
	0.0033														
	0.0039														
	0.0047														
	0.0056	この範囲はMPEシリーズ(1250Vdc)をご使用ください The item of this range, please select out of MPE(1250Vdc) series.													
	0.0068														
	0.0082														
	0.01														
	0.012														
	0.015														
	0.018														
	0.022	18.0	7.5	13.0	15.0	5.0/7.5/10.0/15.0	0.8	100	2,000	-	-	400	400	-	800MPE223J**
	0.027	18.0	8.0	13.5	15.0	5.0/7.5/10.0/15.0	0.8	100	2,000	-	-	400	300	-	800MPE273J**
	0.033	18.0	9.0	14.0	15.0	5.0/7.5/10.0/15.0	0.8	200	1,000	-	-	400	300	-	800MPE333J**
	0.039	18.0	9.5	15.0	15.0	5.0/7.5/10.0/15.0	0.8	200	1,000	-	-	300	300	-	800MPE393J**
	0.047	18.0	9.5	16.5	15.0	5.0/7.5/10.0/15.0	0.8	200	1,000	-	-	300	300	-	800MPE473J**
	0.056	18.0	10.5	17.5	15.0	5.0/7.5/10.0/15.0	0.8	200	1,000	-	-	-	-	-	800MPE563J**
	0.068	18.0	11.5	18.5	15.0	5.0/7.5/10.0/15.0	0.8	200	1,000	-	-	-	-	-	800MPE683J**
	0.082	18.0	12.0	20.5	15.0	5.0/7.5/10.0/15.0	0.8	200	800	-	-	-	-	-	800MPE823J**
	0.1	18.5	13.5	22.0	15.0	5.0/7.5/10.0/15.0	1.0	100	800	-	-	-	-	-	800MPE104J**
	0.12	18.5	15.0	23.5	15.0	5.0/7.5/10.0/15.0	1.0	100	500	-	-	-	-	-	800MPE124J**
	0.15	18.5	16.5	25.5	15.0	5.0/7.5/10.0/15.0	1.0	100	500	-	-	-	-	-	800MPE154J**
	0.18	18.5	18.5	27.5	15.0	5.0/7.5/10.0/15.0	1.0	100	500	-	-	-	-	-	800MPE184J**
0.22	18.5	20.5	29.5	15.0	5.0/7.5/10.0/15.0	1.0	100	500	-	-	-	-	-	800MPE224J**	
0.27	18.5	22.5	31.5	15.0	5.0/7.5/10.0/15.0	1.0	100	300	-	-	-	-	-	800MPE274J**	
0.33	23.5	21.5	30.0	20.0	20.0	1.0	100	300	-	-	-	-	-	800MPE334J**	
0.39	23.5	23.0	32.0	20.0	20.0	1.2	50	200	-	-	-	-	-	800MPE394J**	
0.47	23.5	25.0	34.0	20.0	20.0	1.2	50	200	-	-	-	-	-	800MPE474J**	
0.56	23.5	27.5	36.5	20.0	20.0	1.2	50	200	-	-	-	-	-	800MPE564J**	
1250Vdc / 400Vac	0.001	この範囲はMPEシリーズ(1600Vdc)をご使用ください The item of this range, please select out of MPE(1600Vdc) series.													
	0.0012														
	0.0015														
	0.0018														
	0.0022	18.0	5.5	9.5	15.0	5.0/7.5/10.0/15.0	0.6	200	4,000	-	-	500	500	-	121MPE222J**P0520
	0.0027	18.0	5.5	11.0	15.0	5.0/7.5/10.0/15.0	0.6	100	3,000	-	-	500	500	-	121MPE272J**P0520
	0.0033	18.0	5.5	11.5	15.0	5.0/7.5/10.0/15.0	0.6	100	3,000	-	-	500	500	-	121MPE332J**P0520
	0.0039	18.0	6.0	11.5	15.0	5.0/7.5/10.0/15.0	0.6	100	2,000	-	-	500	500	-	121MPE392J**P0520
	0.0047	18.0	6.5	12.0	15.0	5.0/7.5/10.0/15.0	0.6	100	2,000	-	-	500	400	-	121MPE472J**P0520
	0.0056	18.0	7.0	12.5	15.0	5.0/7.5/10.0/15.0	0.6	100	2,000	-	-	500	400	-	121MPE562J**P0520
	0.0068	18.0	7.5	13.0	15.0	5.0/7.5/10.0/15.0	0.6	100	2,000	-	-	400	400	-	121MPE682J**P0520
	0.0082	18.0	6.0	11.0	15.0	5.0/7.5/10.0/15.0	0.6	100	2,000	-	-	400	300	-	121MPE822J**P0520
	0.01	18.0	7.0	12.5	15.0	5.0/7.5/10.0/15.0	0.6	100	1,000	-	-	400	300	-	121MPE103J**P0520
	0.012	18.0	7.0	12.5	15.0	5.0/7.5/10.0/15.0	0.6	100	2,000	-	-	500	400	-	121MPE123J**P0520
	0.015	18.0	7.5	13.0	15.0	5.0/7.5/10.0/15.0	0.6	100	2,000	-	-	400	400	-	121MPE153J**P0520
	0.018	18.0	8.0	13.5	15.0	5.0/7.5/10.0/15.0	0.6	100	2,000	-	-	400	300	-	121MPE183J**P0520
	0.022	18.0	8.0	15.5	15.0	5.0/7.5/10.0/15.0	0.8	100	1,000	-	-	400	300	-	121MPE223J**
	0.027	18.0	9.0	16.0	15.0	5.0/7.5/10.0/15.0	0.8	200	1,000	-	-	400	300	-	121MPE273J**
	0.033	18.0	9.5	18.0	15.0	5.0/7.5/10.0/15.0	0.8	200	1,000	-	-	-	-	-	121MPE333J**
	0.039	18.0	10.0	18.5	15.0	5.0/7.5/10.0/15.0	0.8	200	1,000	-	-	-	-	-	121MPE393J**
	0.047	18.5	11.5	20.0	15.0	5.0/7.5/10.0/15.0	0.8	200	1,000	-	-	-	-	-	121MPE473J**
	0.056	18.5	12.0	20.5	15.0	5.0/7.5/10.0/15.0	0.8	200	800	-	-	-	-	-	121MPE563J**
	0.068	18.5	13.0	21.5	15.0	5.0/7.5/10.0/15.0	1.0	200	800	-	-	-	-	-	121MPE683J**
	0.082	18.5	14.5	23.0	15.0	5.0/7.5/10.0/15.0	1.0	100	500	-	-	-	-	-	121MPE823J**
	0.1	18.5	16.0	25.0	15.0	5.0/7.5/10.0/15.0	1.0	100	500	-	-	-	-	-	121MPE104J**
	0.12	18.5	17.0	27.5	15.0	5.0/7.5/10.0/15.0	1.0	100	500	-	-	-	-	-	121MPE124J**
	0.15	18.5	20.0	29.0	15.0	5.0/7.5/10.0/15.0	1.0	100	500	-	-	-	-	-	121MPE154J**
	0.18	18.5	22.0	31.0	15.0	5.0/7.5/10.0/15.0	1.0	100	400	-	-	-	-	-	121MPE184J**
0.22	23.5	20.5	30.0	20.0	20.0	1.0	100	300	-	-	-	-	-	121MPE224J**	
0.27	23.5	23.0	32.0	20.0	20.0	1.2	50	200	-	-	-	-	-	121MPE274J**	
0.33	23.5	25.5	34.5	20.0	20.0	1.2	50	200	-	-	-	-	-	121MPE334J**	

・上記以外の容量はお問い合わせください。
For details, please consult our sales offices.

◆標準品一覧表 / STANDARD SIZE

**：リード加工記号 / Lead Forming

定格電圧 Rated Voltage	静電容量 Capacitance (μF)	寸法 Dimensions (mm)						標準梱包数 / Typical Packaging Quantity (pcs)							品番 Part No
		A	B	C	F \pm 1.0	LS \pm 0.5	d	ロングリード品 Long Lead type		テーピング(つづら)品 - 形状別 Taping Ammo Pack Type - Style					
								Bag	Carton	TC	TX,TH	TL,TJ	TN	TS	
1600Vdc / 700Vac	0.001	18.0	6.0	9.0	15.0	5.0/7.5/10.0/15.0	0.6	200	4000	-	-	500	500	-	161MPE102J**P0520
	0.0012	18.0	6.0	9.0	15.0	5.0/7.5/10.0/15.0	0.6	200	4000	-	-	500	500	-	161MPE122J**P0520
	0.0015	18.0	6.0	9.0	15.0	5.0/7.5/10.0/15.0	0.6	200	3000	-	-	500	500	-	161MPE152J**P0520
	0.0018	18.0	6.0	10.5	15.0	5.0/7.5/10.0/15.0	0.6	100	2000	-	-	500	500	-	161MPE182J**P0520
	0.0022	18.0	6.0	12.5	15.0	5.0/7.5/10.0/15.0	0.6	100	2000	-	-	500	500	-	161MPE222J**P0520
	0.0027	18.0	6.0	13.0	15.0	5.0/7.5/10.0/15.0	0.6	100	2000	-	-	500	500	-	161MPE272J**P0520
	0.0033	18.0	6.0	14.5	15.0	5.0/7.5/10.0/15.0	0.6	100	2000	-	-	500	500	-	161MPE332J**P0520
	0.0039	18.0	7.5	14.5	15.0	5.0/7.5/10.0/15.0	0.6	100	1000	-	-	400	400	-	161MPE392J**P0520
	0.0047	18.0	7.5	15.5	15.0	5.0/7.5/10.0/15.0	0.6	100	1000	-	-	400	400	-	161MPE472J**P0520
	0.0056	18.0	8.5	17.0	15.0	5.0/7.5/10.0/15.0	0.8	200	1000	-	-	400	300	-	161MPE562J**
	0.0068	18.0	8.5	17.0	15.0	5.0/7.5/10.0/15.0	0.8	200	1000	-	-	400	300	-	161MPE682J**
	0.0082	18.0	8.5	17.5	15.0	5.0/7.5/10.0/15.0	0.8	200	1000	-	-	400	300	-	161MPE822J**
	0.01	18.0	10.0	18.5	15.0	5.0/7.5/10.0/15.0	0.8	200	1000	-	-	300	300	-	161MPE103J**
	0.012	18.0	11.5	20.0	15.0	5.0/7.5/10.0/15.0	0.8	200	1000	-	-	-	-	-	161MPE123J**
	0.015	18.5	12.0	22.5	15.0	5.0/7.5/10.0/15.0	0.8	200	800	-	-	-	-	-	161MPE153J**
	0.018	18.5	13.5	24.0	15.0	5.0/7.5/10.0/15.0	0.8	100	500	-	-	-	-	-	161MPE183J**
	0.022	18.5	15.5	25.5	15.0	5.0/7.5/10.0/15.0	0.8	100	500	-	-	-	-	-	161MPE223J**
	0.027	18.5	17.0	27.0	15.0	5.0/7.5/10.0/15.0	0.8	100	500	-	-	-	-	-	161MPE273J**
	0.033	18.5	19.0	28.5	15.0	5.0/7.5/10.0/15.0	0.8	100	500	-	-	-	-	-	161MPE333J**
	0.039	18.5	21.0	30.0	15.0	5.0/7.5/10.0/15.0	1.0	100	500	-	-	-	-	-	161MPE393J**
0.047	18.5	23.0	32.0	15.0	5.0/7.5/10.0/15.0	1.0	100	500	-	-	-	-	-	161MPE473J**	
0.056	23.5	21.5	30.0	20.0	20.0	1.0	100	300	-	-	-	-	-	161MPE563J**	
0.068	23.5	23.5	32.5	20.0	20.0	1.2	50	300	-	-	-	-	-	161MPE683J**	
0.082	23.5	25.5	34.5	20.0	20.0	1.2	50	200	-	-	-	-	-	161MPE823J**	
0.1	23.5	28.5	37.5	20.0	20.0	1.2	50	200	-	-	-	-	-	161MPE104J**	

・上記以外の容量はお問い合わせください。
For details, please consult our sales offices.

MPKA series

交流雑音防止用 小形化品
Across-the-line, Miniaturized

・外装に難燃性(UL94 V-0)のエポキシ樹脂を使用していますので、
安全性に優れています。
Coated with flame-retardant (UL94 V-0) epoxy resin.



◆規格表/SPECIFICATION

項目 Item	特性 Characteristics
カテゴリ温度範囲 Category Temperature Range	-40~+85°C
定格電圧範囲 Rated Voltage Range(U _R)	125Vac, 275Vac
静電容量許容差 Capacitance Tolerance	±10%(K)
誘電正接 tan δ	0.001max at 1kHz
耐電圧 Voltage Proof	U _R × 230% 60s
絶縁抵抗 Insulation Resistance	125Vac C ≤ 0.33 μF : 9000M Ω C > 0.33 μF : 3000 Ω F min 275Vac 2000M Ω min
準拠規格 Reference Standard	JIS C 5101-1

◆呼称方法/PART NUMBER

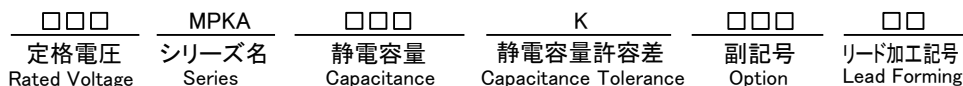

◆寸法図/DIMENSIONS

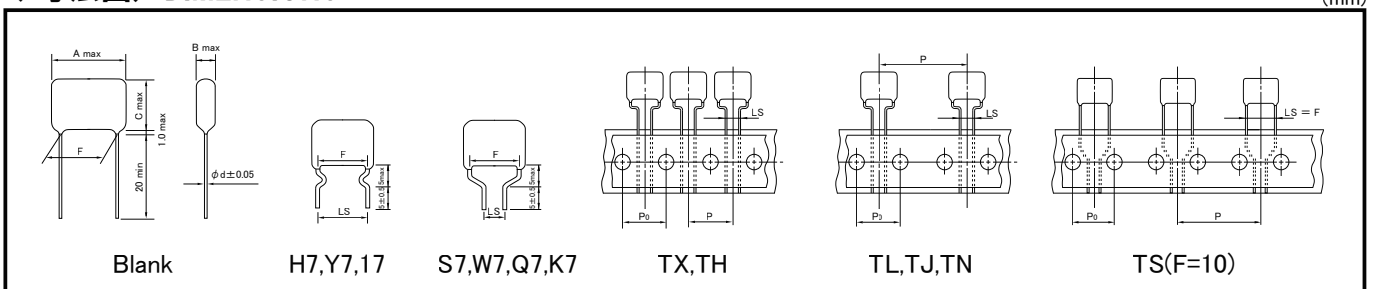

- 注) 1. 接続条件 (Fig.1, Fig.2)
2. 雑音防止用として使用の場合、パルス電圧はTable 1の値以下として下さい。

- Note) 1. Operating circuit (Fig.1, Fig.2)
2. When operating capacitor for noise suppression, voltage of pulse applied to the capacitor shall be within value specified in Table 1.

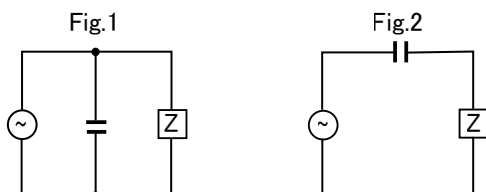

定格電圧 Rated Voltage	パルス電圧 Pulse Voltage
125Vac	250Vo-p
275Vac	630Vo-p

◆標準品一覧表/STANDARD SIZE

**：リード加工記号/Lead Forming

定格電圧 Rated Voltage (Vac)	静電容量 Capacitance (μ F)	寸法 Dimensions (mm)						標準梱包数/Typical Packaging Quantity (pcs)							品番 Part No
		A	B	C	F \pm 1.0	LS \pm 0.5	d	ロングリード品 Long Lead type		テーピング(つづら)品 - 形状別 Taping Ammo Pack Type - Style					
								Bag	Carton	TC	TX,TH	TL,TJ	TN	TS	
125	0.01	13.0	6.0	9.5	10.0	5.0/7.5/10.0	0.6	200	4,000	-	500	400	-	400	125MPKA103K**
	0.012	13.0	7.0	10.0	10.0	5.0/7.5/10.0	0.6	200	4,000	-	500	400	-	400	125MPKA123K**
	0.015	13.0	7.0	10.5	10.0	5.0/7.5/10.0	0.6	200	3,000	-	500	400	-	400	125MPKA153K**
	0.018	13.0	7.5	11.0	10.0	5.0/7.5/10.0	0.6	100	3,000	-	500	400	-	400	125MPKA183K**
	0.022	13.0	8.5	11.5	10.0	5.0/7.5/10.0	0.6	100	3,000	-	500	400	-	400	125MPKA223K**
	0.027	13.0	8.0	13.0	10.0	5.0/7.5/10.0	0.6	100	2,000	-	500	400	-	400	125MPKA273K**
	0.033	13.0	5.5	10.5	10.0	5.0/7.5/10.0	0.6	200	4,000	-	500	400	-	400	125MPKA333K**
	0.039	13.0	5.5	11.0	10.0	5.0/7.5/10.0	0.6	200	4,000	-	500	400	-	400	125MPKA393K**
	0.047	13.0	6.0	11.5	10.0	5.0/7.5/10.0	0.6	200	3,000	-	500	400	-	400	125MPKA473K**
	0.056	13.0	7.0	12.0	10.0	5.0/7.5/10.0	0.6	100	3,000	-	500	400	-	400	125MPKA563K**
	0.068	13.0	6.5	11.0	10.0	5.0/7.5/10.0	0.6	200	4,000	-	500	400	-	400	125MPKA683K**
	0.082	13.0	6.5	11.5	10.0	5.0/7.5/10.0	0.6	200	3,000	-	500	400	-	400	125MPKA823K**
	0.1	13.0	6.5	11.0	10.0	5.0/7.5/10.0	0.6	200	4,000	-	500	400	-	400	125MPKA104K**
	0.12	13.0	6.5	11.5	10.0	5.0/7.5/10.0	0.6	200	3,000	-	500	400	-	400	125MPKA124K**
	0.15	13.0	7.0	12.0	10.0	5.0/7.5/10.0	0.6	100	3,000	-	500	400	-	400	125MPKA154K**
	0.18	13.0	6.0	11.5	10.0	5.0/7.5/10.0	0.6	200	3,000	-	500	400	-	400	125MPKA184K**
	0.22	13.0	6.5	13.0	10.0	5.0/7.5/10.0	0.6	100	3,000	-	500	400	-	400	125MPKA224K**
	0.27	13.0	6.5	13.5	10.0	5.0/7.5/10.0	0.6	100	3,000	-	500	400	-	400	125MPKA274K**
	0.33	13.0	8.0	14.0	10.0	5.0/7.5/10.0	0.6	100	2,000	-	500	400	-	400	125MPKA334K**
	0.39	18.0	7.5	13.5	15.0	5.0/7.5/10.0/15.0	0.6	100	2,000	-	-	400	400	-	125MPKA394K**
0.47	18.0	8.0	14.0	15.0	5.0/7.5/10.0/15.0	0.6	100	2,000	-	-	400	400	-	125MPKA474K**	
0.56	18.0	7.0	12.5	15.0	5.0/7.5/10.0/15.0	0.6	100	2,000	-	-	400	400	-	125MPKA564K**	
0.68	18.0	7.5	13.0	15.0	5.0/7.5/10.0/15.0	0.6	100	1,500	-	-	400	400	-	125MPKA684K**	
0.82	18.0	8.0	13.5	15.0	5.0/7.5/10.0/15.0	0.6	100	1,500	-	-	400	300	-	125MPKA824K**	
1	18.0	9.0	14.5	15.0	5.0/7.5/10.0/15.0	0.6	100	1,500	-	-	400	300	-	125MPKA105K**	
275	0.01	13.0	6.0	11.5	10.0	5.0/7.5/10.0	0.6	200	4,000	-	1000	500	-	500	275MPKA103K**
	0.012	13.0	6.5	12.0	10.0	5.0/7.5/10.0	0.6	200	3,000	-	500	500	-	500	275MPKA123K**
	0.015	13.0	7.0	12.5	10.0	5.0/7.5/10.0	0.6	100	3,000	-	500	500	-	500	275MPKA153K**
	0.018	13.0	7.5	13.0	10.0	5.0/7.5/10.0	0.6	100	2,000	-	500	400	-	400	275MPKA183K**
	0.022	13.0	6.5	12.0	10.0	5.0/7.5/10.0	0.6	100	3,000	-	500	500	-	500	275MPKA223K**
	0.027	13.0	7.0	12.5	10.0	5.0/7.5/10.0	0.6	100	3,000	-	500	500	-	500	275MPKA273K**
	0.033	13.0	7.5	13.0	10.0	5.0/7.5/10.0	0.6	100	2,000	-	500	400	-	400	275MPKA333K**
	0.039	13.0	8.0	13.5	10.0	5.0/7.5/10.0	0.6	100	2,000	-	500	400	-	400	275MPKA393K**
	0.047	13.0	8.5	14.0	10.0	5.0/7.5/10.0	0.6	100	2,000	-	500	400	-	400	275MPKA473K**
	0.056	13.0	6.5	12.0	10.0	5.0/7.5/10.0	0.6	100	3,000	-	500	500	-	500	275MPKA563K**
	0.068	13.0	7.0	12.5	10.0	5.0/7.5/10.0	0.6	100	3,000	-	500	500	-	500	275MPKA683K**
	0.082	13.0	7.5	13.0	10.0	5.0/7.5/10.0	0.6	100	2,000	-	500	400	-	400	275MPKA823K**
	0.1	13.0	8.0	13.0	10.0	5.0/7.5/10.0	0.6	100	2,000	-	500	400	-	400	275MPKA104K**
	0.12	18.0	6.0	12.0	15.0	5.0/7.5/10.0/15.0	0.6	100	2,000	-	-	500	500	-	275MPKA124K**
	0.15	18.0	6.5	12.5	15.0	5.0/7.5/10.0/15.0	0.6	100	2,000	-	-	500	400	-	275MPKA154K**
	0.18	18.0	6.5	12.0	15.0	5.0/7.5/10.0/15.0	0.6	100	2,000	-	-	500	400	-	275MPKA184K**
	0.22	18.0	7.5	13.0	15.0	5.0/7.5/10.0/15.0	0.6	100	2,000	-	-	500	400	-	275MPKA224K**
	0.27	18.0	7.5	13.0	15.0	5.0/7.5/10.0/15.0	0.6	100	2,000	-	-	400	400	-	275MPKA274K**
	0.33	18.0	8.0	13.5	15.0	5.0/7.5/10.0/15.0	0.8	100	1,000	-	-	400	300	-	275MPKA334K**
	0.39	18.0	9.0	15.0	15.0	5.0/7.5/10.0/15.0	0.8	100	1,000	-	-	400	300	-	275MPKA394K**
0.47	18.0	9.5	15.5	15.0	5.0/7.5/10.0/15.0	0.8	100	1,000	-	-	300	300	-	275MPKA474K**	
0.56	18.0	9.5	17.0	15.0	5.0/7.5/10.0/15.0	0.8	200	1,000	-	-	300	300	-	275MPKA564K**	
0.68	18.0	10.5	18.5	15.0	5.0/7.5/10.0/15.0	0.8	200	1,000	-	-	300	-	-	275MPKA684K**	
0.82	25.0	9.0	16.5	22.5	15.0/22.5	0.8	200	1,000	-	-	-	-	-	275MPKA824K**	
1	25.0	10.0	17.5	22.5	15.0/22.5	0.8	200	1,000	-	-	-	-	-	275MPKA105K**	

PCK series

大電流 低うなり音品 High Ripple Current, Low Buzz

- ・特殊構造により高リプル化を実現。 High ripple current by special structure.
- ・低ESR化により、大電流に対応。 High current correspondence by low ESR.
- ・製造条件の最適化によりうなり音を低減。 Reduced a buzz by optimization of the production condition.
- ・外装に難燃性(UL94 V-0)のエポキシ樹脂を使用していますので、安全性に優れています。
Coated with flame-retardant (UL94 V-0) epoxy resin.



◆規格表/SPECIFICATION

項目 Item	特性 Characteristics
カテゴリ温度範囲 Category Temperature Range	-40~+105°C ※
定格電圧範囲 Rated Voltage Range(U _R)	450Vdc, 630Vdc, 800Vdc, 1000Vdc, 1250Vdc, 1600Vdc, 2000Vdc
静電容量許容差 Capacitance Tolerance	±5%(J)
誘電正接 tan δ	0.001max at 1kHz
耐電圧 Voltage Proof	U _R × 150% 60s
絶縁抵抗 Insulation Resistance	C ≤ 0.33 μF: 25000M Ω min C > 0.33 μF: 7500 Ω F min
準拠規格 Reference Standard	JIS C5101-16, JIS C5101-1

※85°Cを超える範囲では使用上の注意事項に示す電圧軽減を行ってください。
Derate the voltage as shown CAUTION FOR PROPER USE OF FILM CAPACITORS when using the capacitor beyond 85°C

◆呼称方法/PART NUMBER



◆寸法図/DIMENSIONS

(mm)

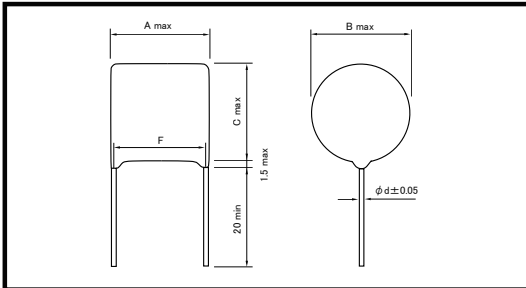

◆周波数に対する許容電流/PERMISSIBLE CURRENT FOR FREQUENCY

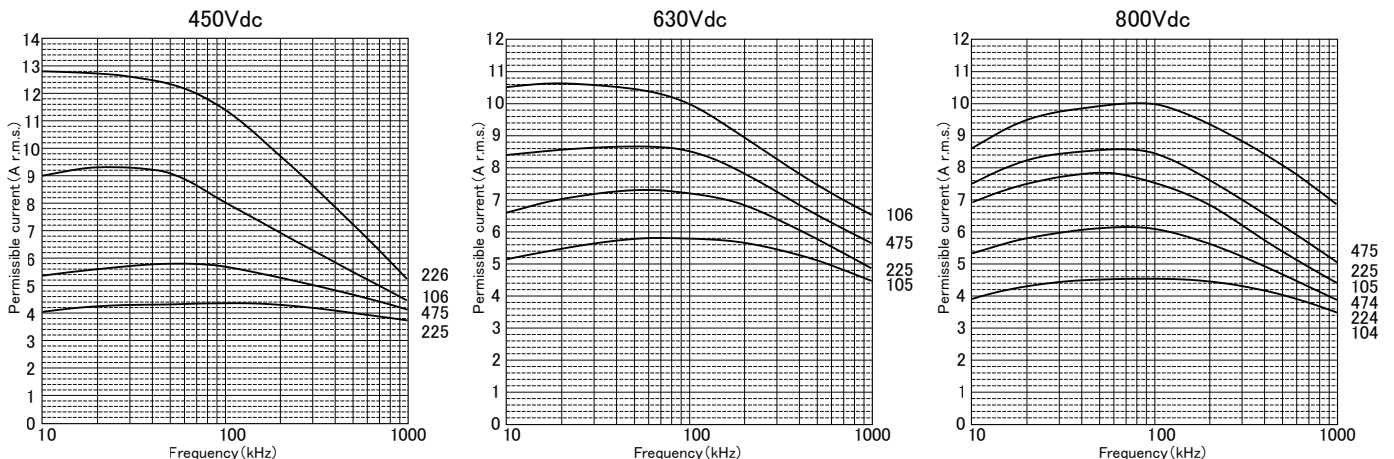

◆標準品一覧表／STANDARD SIZE

**：リード加工記号/Lead Forming

定格電圧 Rated Voltage (Vdc)	静電容量 Capacitance (μ F)	寸法 Dimensions (mm)						標準梱包数/Typical Packaging Quantity (pcs)		品番 Part No
		A	B	C	F \pm 1.0	LS \pm 0.5	d	ロングリード品 Long Lead type		
								Bag	Carton	
450	2.2	21.0	16.5	18.5	17.5	-	1.0	100	500	450PCK225J**
	3.3	21.0	19.0	21.0	17.5	-	1.0	100	500	450PCK335J**
	4.7	26.0	19.0	21.0	22.5	-	1.0	100	400	450PCK475J**
	6.8	26.0	22.0	24.0	22.5	-	1.2	100	300	450PCK685J**
	10	26.0	25.5	27.5	22.5	-	1.2	50	250	450PCK106J**
	15	26.0	30.0	32.0	22.5	-	1.2	50	200	450PCK156J**
	22	26.0	35.5	37.5	22.5	-	1.2	40	160	450PCK226J**
630	33	36.0	35.0	37.0	32.5	-	1.2	20	100	450PCK336J**
	1	21.0	16.0	18.0	17.5	-	1.0	100	800	630PCK105J**
	1.5	21.0	19.0	21.0	17.5	-	1.0	100	500	630PCK155J**
	2.2	21.0	22.0	24.0	17.5	-	1.0	100	400	630PCK225J**
	3.3	26.0	23.0	25.0	22.5	-	1.2	100	300	630PCK335J**
	4.7	26.0	26.0	28.0	22.5	-	1.2	50	300	630PCK475J**
	6.8	26.0	30.0	32.0	22.5	-	1.2	50	200	630PCK685J**
800	10	36.0	30.0	32.0	32.5	-	1.2	40	160	630PCK106J**
	15	36.0	34.0	36.0	32.5	-	1.2	40	120	630PCK156J**
	0.68	21.0	18.0	20.0	17.5	-	1.0	100	500	800PCK684J**
	1	21.0	21.0	23.0	17.5	-	1.0	100	500	800PCK105J**
	1.5	21.0	24.5	26.5	17.5	-	1.0	100	300	800PCK155J**
	2.2	21.0	28.5	30.5	17.5	-	1.2	50	250	800PCK225J**
	3.3	26.0	30.0	32.0	22.5	-	1.2	50	200	800PCK335J**
1000	4.7	26.0	35.0	37.0	22.5	-	1.2	40	160	800PCK475J**
	6.8	36.0	34.0	36.0	32.5	-	1.2	40	120	800PCK685J**
	10	36.0	40.0	42.0	32.5	-	1.2	20	80	800PCK106J**
	0.68	21.0	22.5	24.5	17.5	-	1.0	100	300	101PCK684J**
	1	21.0	26.5	28.5	17.5	-	1.2	100	300	101PCK105J**
	1.5	26.0	26.5	28.5	22.5	-	1.2	50	200	101PCK155J**
	2.2	26.0	31.5	33.5	22.5	-	1.2	50	200	101PCK225J**
1250	3.3	36.0	30.5	32.5	32.5	-	1.2	40	160	101PCK335J**
	4.7	36.0	36.0	38.0	32.5	-	1.2	20	100	101PCK475J**
	0.22	21.0	19.0	21.0	17.5	-	1.0	100	500	121PCK224J**
	0.33	21.0	22.5	24.5	17.5	-	1.0	100	300	121PCK334J**
	0.47	21.0	26.0	28.0	17.5	-	1.0	100	300	121PCK474J**
	0.68	21.0	30.5	32.5	17.5	-	1.2	50	200	121PCK684J**
	1	26.0	29.5	31.5	22.5	-	1.2	50	200	121PCK105J**
1250	1.5	26.0	35.5	37.5	22.5	-	1.2	40	160	121PCK155J**
	2.2	36.0	33.5	35.5	32.5	-	1.2	40	120	121PCK225J**
	3.3	36.0	40.0	42.0	32.5	-	1.2	20	80	121PCK335J**

- ・上記以外の容量はお問い合わせください。
For details, please consult our sales offices.
- ・AC品も対応可能です。ご相談ください。
AC type is also available.

◆周波数に対する許容電流／PERMISSIBLE CURRENT FOR FREQUENCY

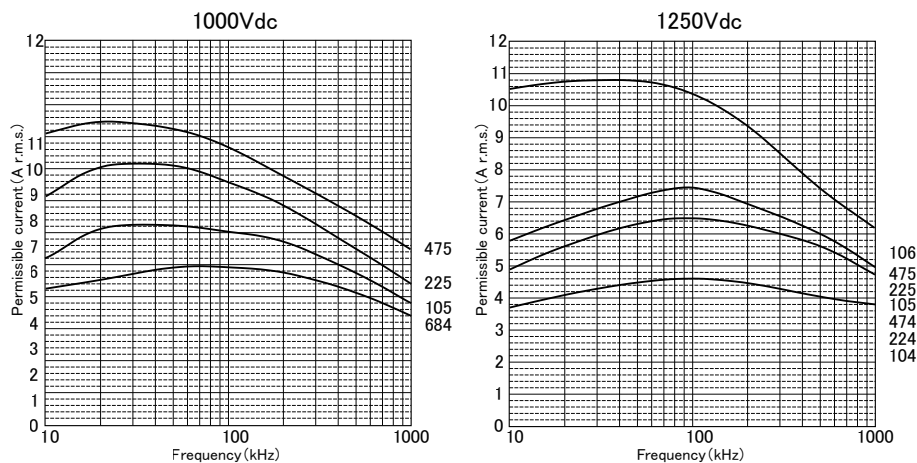

◆標準品一覧表／STANDARD SIZE

**：リード加工記号/Lead Forming

定格電圧 Rated Voltage (Vdc)	静電容量 Capacitance (μ F)	寸法 Dimensions (mm)						標準梱包数/Typical Packaging Quantity (pcs)		品番 Part No
		A	B	C	F \pm 1.0	LS \pm 0.5	d	ロングリード品 Long Lead type		
								Bag	Carton	
1600	0.1	29.0	23.0	25.0	25.0	-	1.2	50	300	161PCK104J**
	0.15	29.0	27.0	29.0	25.0	-	1.2	50	200	161PCK154J**
	0.22	35.0	25.0	27.0	31.5	-	1.2	50	200	161PCK224J**
	0.33	35.0	29.0	31.0	31.5	-	1.2	40	200	161PCK334J**
	0.47	35.0	34.0	36.0	31.5	-	1.2	40	120	161PCK474J**
2000	0.01	29.0	17.0	19.0	25.0	-	1.0	100	500	201PCK103J**
	0.015	29.0	19.0	21.0	25.0	-	1.0	100	300	201PCK153J**
	0.022	29.0	22.0	24.0	25.0	-	1.2	100	300	201PCK223J**
	0.033	29.0	25.5	27.5	25.0	-	1.2	50	200	201PCK333J**
	0.047	29.0	30.0	32.0	25.0	-	1.2	50	200	201PCK473J**
	0.068	35.0	22.0	24.0	31.5	-	1.2	50	250	201PCK683J**
	0.1	35.0	25.5	27.5	31.5	-	1.2	50	200	201PCK104J**
	0.15	35.0	30.0	32.0	31.5	-	1.2	40	160	201PCK154J**
	0.22	45.0	31.0	33.0	41.5	-	1.2	20	100	201PCK224J**

- ・上記以外の容量はお問い合わせください。
For details, please consult our sales offices.
- ・AC品も対応可能です。ご相談ください。
AC type is also available.

◆周波数に対する許容電流／PERMISSIBLE CURRENT FOR FREQUENCY

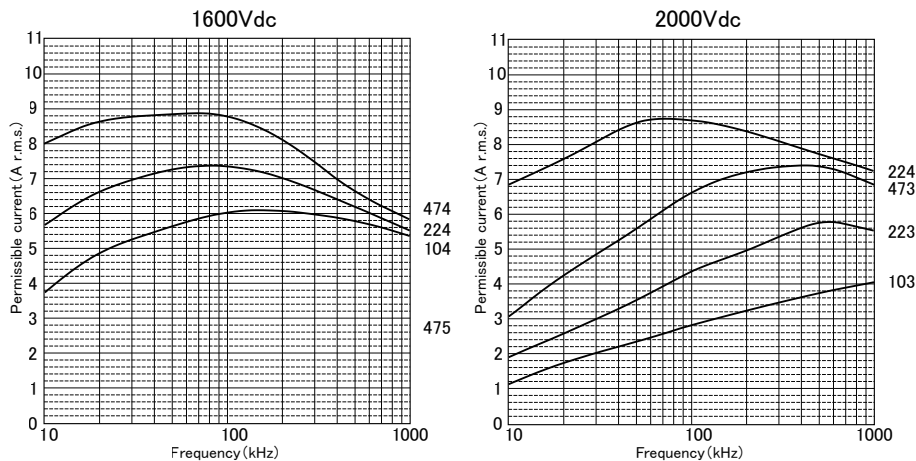

MPF series

超高電圧品 Ultra high voltage

- ・20,000Vdcまで対応可能
Ultra high voltage film capacitor can be used up to 20,000Vdc
- ・用途: 高圧装置, X線装置, レーザ装置, 電子顕微鏡等
Application: High voltage power supply, X-ray device, Laser device, Electric microscope, etc.
- ・使用用途に応じたカスタム品 Custom design is available.

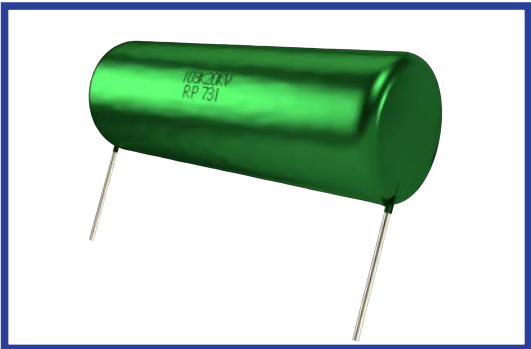

◆規格表 / SPECIFICATION

項目 Item	特性 Characteristics
カテゴリ温度範囲 Category Temperature Range	-40 ~ +85°C
定格電圧範囲 Rated Voltage Range (U _R)	10,000Vdc ~ 20,000Vdc
静電容量許容差 Capacitance Tolerance	±5%(J)
誘電正接 tan δ	0.001max at 1kHz
耐電圧 Voltage Proof	U _R × 150% 5s
絶縁抵抗 Insulation Resistance	7500 Ω Fmin
準拠規格 Reference Standard	JIS C5101-16, JIS C5101-1

◆呼称方法 / PART NUMBER

□□□
MPF
□□□
J
□□□
□□
P□□□□
 定格電圧 シリーズ名 静電容量 静電容量許容差 副記号 リード加工記号 特殊記号
 Rated Voltage Series Capacitance Capacitance Tolerance Option Lead Forming Special number

◆寸法図 / DIMENSIONS

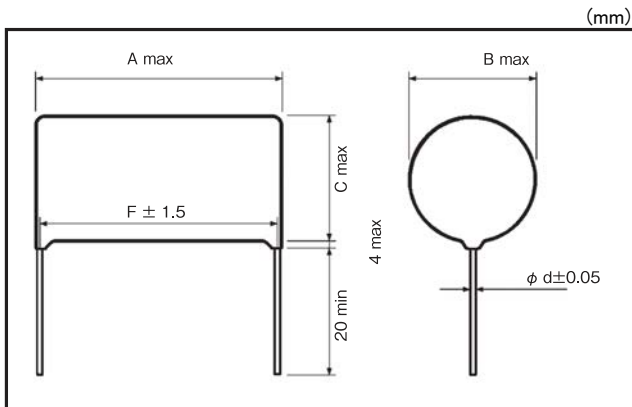

寸法例
e.g. 20,000Vdc / 10,000pF
 A : 82.0mm
 B : 28.0mm
 C : 29.0mm
 F : 75.5mm ±1.5
 d : 1.2mm

静電容量範囲例
 10,000Vdc : 10,000pF ~ 33,000pF
 20,000Vdc : 4,700pF ~ 15,000pF

◆使用例 / EXAMPLE OF USE コッククロフト・ウォルトン回路 (Cockcroft-Walton circuit)

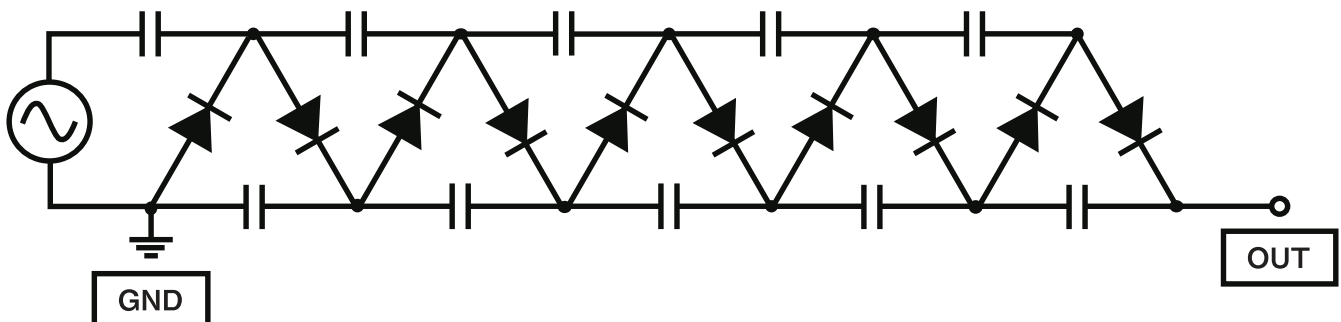

MPT series

125°C対応品 High Temperature (+125°C)

- 車載機器等の高温用途(125°C)に最適です。
Solutions for high temperature applications such as automotive electronics at 125°C.
- 電動コンプレッサなどの大電流回路に最適です。
Suitable for large current circuits of Electric compressors

AEC-Q200

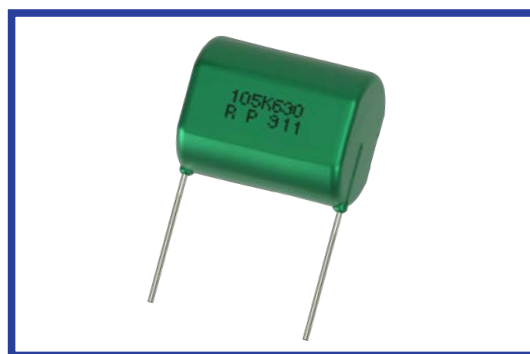

◆規格表/SPECIFICATION

項目 Item	特性 Characteristics
カテゴリ温度範囲 Category Temperature Range	-40~+125°C
定格電圧範囲 Rated Voltage Range(U _R)	630Vdc
静電容量許容差 Capacitance Tolerance	±5%(J)
誘電正接 tan δ	0.001max at 1kHz
耐電圧 Voltage Proof	U _R × 150% 60s
絶縁抵抗 Insulation Resistance	7500 Ω F min
準拠規格 Reference Standard	JIS C 5101-16, JIS C 5101-1

◆呼称方法/PART NUMBER

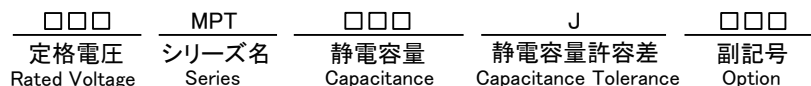

◆周波数に対する許容電流
/PERMISSIBLE CURRENT FOR FREQUENCY

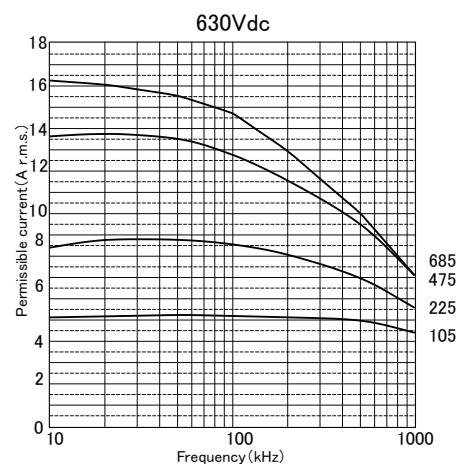

◆寸法図/DIMENSIONS

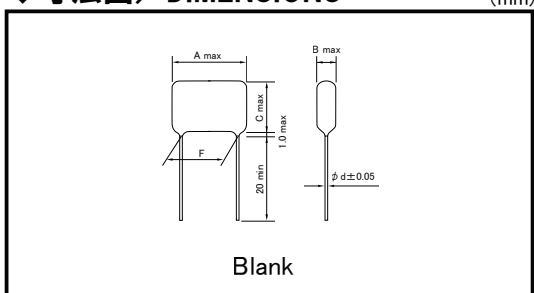

◆標準品一覧表/STANDARD SIZE

定格電圧 Rated Voltage (Vdc)	静電容量 Capacitance (μF)	寸法 Dimensions (mm)					標準梱包数/Typical Packaging Quantity (pcs)		品番 Part No
		A	B	C	F±1.0	d	ロングリード品 Long Lead type		
							Bag	Carton	
630	1.0	25.5	10.5	17.0	22.5	1.0	200	1000	630MPT105J
	1.5	25.5	12.5	21.0	22.5	1.0	100	500	630MPT155J
	2.2	25.5	14.0	24.0	22.5	1.0	100	500	630MPT225J
	3.3	25.5	17.5	27.5	22.5	1.0	100	300	630MPT335J
	4.7	25.5	21.0	30.5	22.5	1.0	50	300	630MPT475J
	6.8	25.5	25.0	34.0	22.5	1.0	50	200	630MPT685J

MPY series

小形化 大電流品 Miniaturized, High Ripple Current

- インバータなどの高周波・大電流回路に最適です。
For applications where high frequency and high current are required.
- 縦長構造により実装面積を削減できます。
The vertically long structure can reduce the mounting area.
- 産業用電源、インバーターなどの高周波・大電流回路に最適です。
For applications where high frequency and high current are required.



◆規格表 / SPECIFICATION

項目 Item	特性 Characteristics
カテゴリ温度範囲 Category Temperature Range	-40 ~ +105°C
定格電圧範囲 Rated Voltage Range (U _R)	450Vdc
静電容量許容差 Capacitance Tolerance	±5%(J)
誘電正接 tan δ	0.001max at 1kHz
耐電圧 Voltage Proof	U _R × 150% 60s
絶縁抵抗 Insulation Resistance	7500 Ω F min
準拠規格 Reference Standard	JIS C 5101-16, JIS C 5101-1

◆呼称方法 / PART NUMBER

□□□	MPY	□□□	J
定格電圧 Rated Voltage	シリーズ名 Series	静電容量 Capacitance	許容差 Tolerance

◆寸法図 / DIMENSIONS

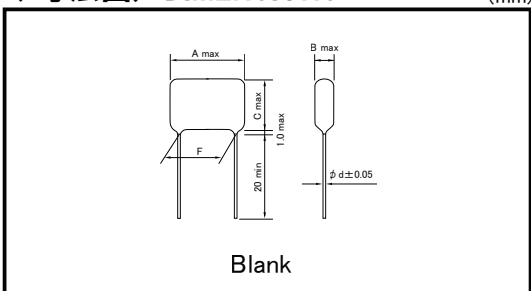

◆周波数に対する許容電流 / PERMISSIBLE CURRENT FOR FREQUENCY

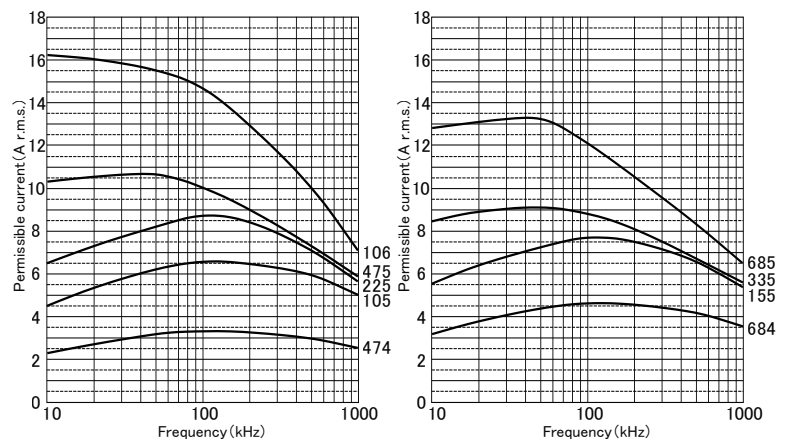

◆標準品一覧表 / STANDARD SIZE

定格電圧 Rated Voltage (Vdc)	静電容量 Capacitance (μF)	寸法 Dimensions (mm)					品番 Part No
		A	B	C	F±1.0	d	
450	0.47	13.5	8.0	13.5	10.0	0.8	450MPY474J
	0.68	13.5	8.5	17.5	10.0	0.8	450MPY684J
	1.0	13.5	10.0	19.5	10.0	1.0	450MPY105J
	1.5	13.5	12.0	23.0	10.0	1.0	450MPY155J
	2.2	13.5	15.0	25.0	10.0	1.0	450MPY225J
	3.3	18.0	14.5	24.0	15.0	1.0	450MPY335J
	4.7	18.0	17.5	27.0	15.0	1.0	450MPY475J
	6.8	18.0	21.0	30.5	15.0	1.0	450MPY685J
10	18.0	27.0	35.0	15.0	1.0	450MPY106J	

MMB series

標準品 Standard

- 自己回復性があり、信頼性が高いコンデンサです。
Reliability is excellent because these capacitors provide self-healing.
- 外装に難燃性(UL94 V-0)のエポキシ樹脂を使用していますので、安全性に優れています。
Coated with flame-retardant (UL94 V-0) epoxy resin.

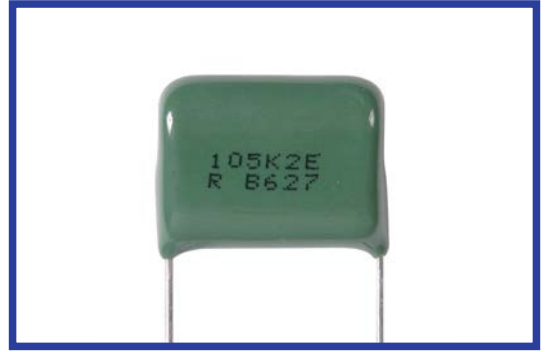

◆規格表/SPECIFICATION

項目 Item	特性 Characteristics
カテゴリ温度範囲 Category Temperature Range	-40~+105°C ※
定格電圧範囲 Rated Voltage Range(U _R)	100Vdc, 250Vdc, 400Vdc, 630Vdc
静電容量許容差 Capacitance Tolerance	±10%(K)
誘電正接 tan δ	0.01max at 1kHz
耐電圧 Voltage Proof	U _R × 150% 60s
絶縁抵抗 Insulation Resistance	C ≤ 0.33 μF: 9000M Ω min C > 0.33 μF: 3000 Ω Fmin
準拠規格 Reference Standard	JIS C 5101-2, JIS C 5101-1

◆呼称方法/PART NUMBER



◆寸法図/DIMENSIONS

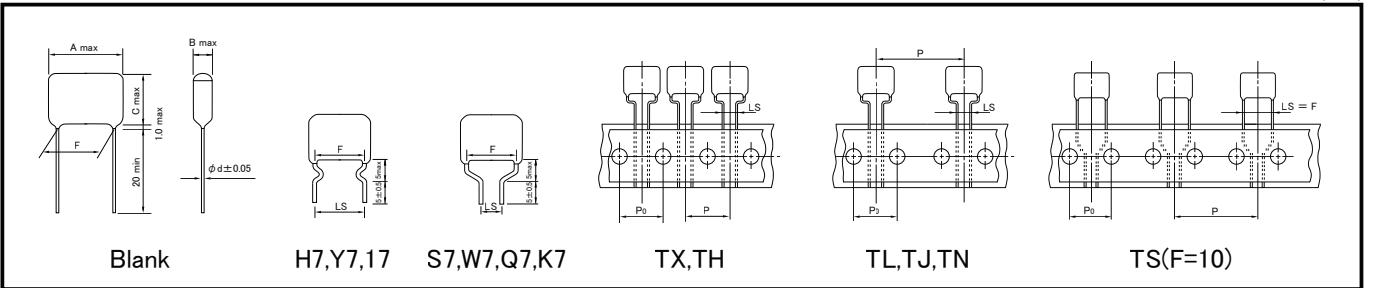

◆周波数に対する許容電流/PERMISSIBLE CURRENT FOR FREQUENCY

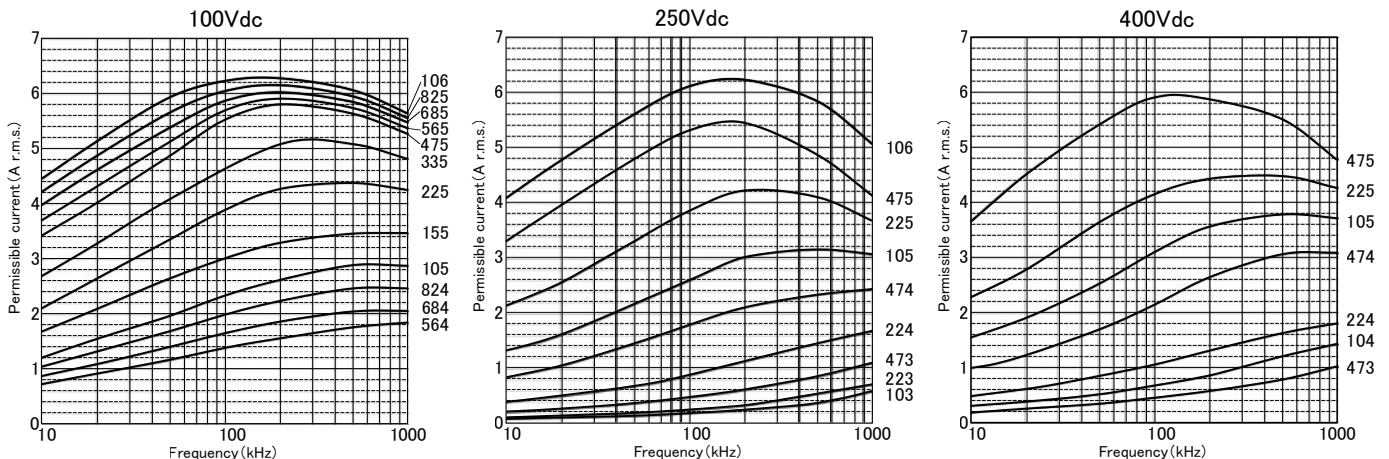

◆標準品一覧表／STANDARD SIZE

**：リード加工記号/Lead Forming

定格電圧 Rated Voltage (Vdc)	静電容量 Capacitance (μ F)	寸法 Dimensions (mm)						標準梱包数/Typical Packaging Quantity (pcs)							品番 Part No
		A	B	C	F \pm 1.0	LS \pm 0.5	d	ロングリード品 Long Lead type		テーピング(つづら)品 - 形状別 Taping Ammo Pack Type - Style					
								Bag	Carton	TC	TX,TH	TL,TJ	TN	TS	
100	0.56	13.0	6.0	11.5	10.0	5.0/7.5/10.0	0.6	200	2,000	—	1000	500	—	500	100MMB564K**
	0.68	13.0	6.0	12.0	10.0	5.0/7.5/10.0	0.6	200	2,000	—	1000	500	—	500	100MMB684K**
	0.82	13.0	6.5	14.0	10.0	5.0/7.5/10.0	0.6	200	1,000	—	1000	500	—	500	100MMB824K**
	1	13.0	7.0	14.5	10.0	5.0/7.5/10.0	0.6	200	2,000	—	1000	500	—	500	100MMB105K**
	1.2	18.0	6.5	14.5	15.0	5.0/7.5/10.0/15.0	0.8	100	2,000	—	—	500	400	—	100MMB125K**
	1.5	18.0	7.5	15.0	15.0	5.0/7.5/10.0/15.0	0.8	100	2,000	—	—	500	400	—	100MMB155K**
	1.8	18.0	8.0	15.5	15.0	5.0/7.5/10.0/15.0	0.8	100	2,000	—	—	400	400	—	100MMB185K**
	2.2	18.0	8.5	16.5	15.0	5.0/7.5/10.0/15.0	0.8	100	2,000	—	—	400	400	—	100MMB225K**
	2.7	18.0	9.5	17.5	15.0	5.0/7.5/10.0/15.0	0.8	100	1,000	—	—	—	—	—	100MMB275K**
	3.3	18.0	10.0	18.0	15.0	5.0/7.5/10.0/15.0	0.8	200	1,000	—	—	—	—	—	100MMB335K**
	3.9	25.5	10.0	17.0	22.5	15.0/22.5	0.8	200	1,000	—	—	—	—	—	100MMB395K**
	4.7	25.5	11.0	18.0	22.5	15.0/22.5	0.8	200	1,000	—	—	—	—	—	100MMB475K**
	5.6	25.5	10.5	19.5	22.5	15.0/22.5	0.8	200	800	—	—	—	—	—	100MMB565K**
6.8	25.5	11.5	20.5	22.5	15.0/22.5	0.8	100	500	—	—	—	—	—	100MMB685K**	
8.2	25.5	12.0	23.0	22.5	15.0/22.5	0.8	100	500	—	—	—	—	—	100MMB825K**	
10	25.5	13.0	24.5	22.5	15.0/22.5	0.8	100	500	—	—	—	—	—	100MMB106K**	
250	0.1	13.0	6.0	12.0	10.0	5.0/7.5/10.0	0.6	200	3,000	—	1000	500	—	500	250MMB104K**P**
	0.12	13.0	6.5	12.5	10.0	5.0/7.5/10.0	0.6	200	3,000	—	500	500	—	500	250MMB124K**P**
	0.15	13.0	7.0	13.0	10.0	5.0/7.5/10.0	0.6	200	2,000	—	500	500	—	500	250MMB154K**P**
	0.18	13.0	5.0	11.0	10.0	5.0/7.5/10.0	0.6	200	5,000	—	1000	500	—	500	250MMB184K**
	0.22	13.0	6.0	11.5	10.0	5.0/7.5/10.0	0.6	200	5,000	—	1000	500	—	500	250MMB224K**
	0.27	13.0	6.5	12.0	10.0	5.0/7.5/10.0	0.6	200	4,000	—	1000	500	—	500	250MMB274K**
	0.33	13.0	6.5	13.0	10.0	5.0/7.5/10.0	0.6	200	3,000	—	1000	500	—	500	250MMB334K**
	0.39	18.0	5.0	11.0	15.0	5.0/7.5/10.0/15.0	0.6	200	3,000	—	—	500	500	—	250MMB394K**
	0.47	18.0	6.0	11.5	15.0	5.0/7.5/10.0/15.0	0.6	100	3,000	—	—	500	500	—	250MMB474K**
	0.56	18.0	6.0	13.0	15.0	5.0/7.5/10.0/15.0	0.6	100	2,000	—	—	500	500	—	250MMB564K**
	0.68	18.0	6.5	13.5	15.0	5.0/7.5/10.0/15.0	0.8	100	2,000	—	—	500	500	—	250MMB684K**
	0.82	18.5	7.0	14.5	15.0	5.0/7.5/10.0/15.0	0.8	100	2,000	—	—	500	400	—	250MMB824K**
	1	18.5	7.5	14.5	15.0	5.0/7.5/10.0/15.0	0.8	100	2,000	—	—	500	400	—	250MMB105K**
	1.2	18.5	7.5	16.5	15.0	5.0/7.5/10.0/15.0	0.8	200	1,000	—	—	400	400	—	250MMB125K**
	1.5	18.5	8.5	17.0	15.0	5.0/7.5/10.0/15.0	0.8	200	1,000	—	—	400	300	—	250MMB155K**
	1.8	25.5	7.0	16.5	22.5	15.0/22.5	0.8	200	1,000	—	—	—	—	—	250MMB185K**
	2.2	25.5	8.5	17.0	22.5	15.0/22.5	0.8	200	1,000	—	—	—	—	—	250MMB225K**
	2.7	25.5	9.0	18.0	22.5	15.0/22.5	0.8	200	800	—	—	—	—	—	250MMB275K**
	3.3	25.5	10.5	19.0	22.5	15.0/22.5	0.8	200	800	—	—	—	—	—	250MMB335K**
	3.9	25.5	11.0	20.0	22.5	15.0/22.5	0.8	100	500	—	—	—	—	—	250MMB395K**
4.7	25.5	12.5	21.5	22.5	15.0/22.5	0.8	100	500	—	—	—	—	—	250MMB475K**	
5.6	31.0	11.0	22.0	27.5	27.5	0.8	100	500	—	—	—	—	—	250MMB565K**	
6.8	31.0	12.5	23.5	27.5	27.5	0.8	100	400	—	—	—	—	—	250MMB685K**	
8.2	31.0	14.0	25.5	27.5	27.5	0.8	50	400	—	—	—	—	—	250MMB825K**	
10	31.0	16.5	28.0	27.5	27.5	0.8	50	300	—	—	—	—	—	250MMB106K**	

◆周波数に対する許容電流／PERMISSIBLE CURRENT FOR FREQUENCY

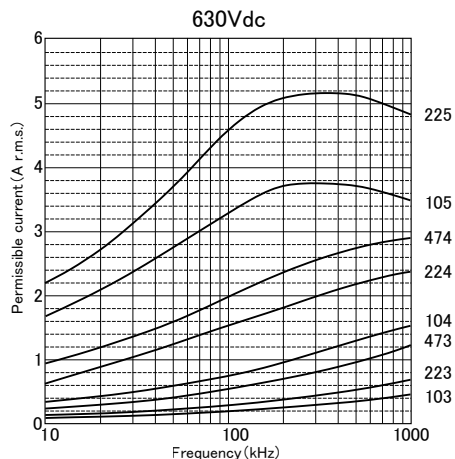

◆標準品一覧表/STANDARD SIZE

**：リード加工記号/Lead Forming

定格電圧 Rated Voltage (Vdc)	静電容量 Capacitance (μ F)	寸法 Dimensions (mm)						標準梱包数/Typical Packaging Quantity (pcs)							品番 Part No
		A	B	C	F \pm 1.0	LS \pm 0.5	d	ロングリード品 Long Lead type		テーピング(つづら)品 - 形状別 Taping Ammo Pack Type - Style					
								Bag	Carton	TC	TX,TH	TL,TJ	TN	TS	
400	0.01	この範囲はMMBシリーズ(630Vdc)をご使用下さい。 The item of this range, please select out of MMB(630Vdc) series.													
	0.012														
	0.015														
	0.018														
	0.022														
	0.027														
	0.033														
	0.039	13.0	5.0	8.0	10.0	5.0/7.5/10.0	0.6	200	6,000	—	1500	500	—	500	400MMB393K**
	0.047	13.0	5.0	8.0	10.0	5.0/7.5/10.0	0.6	200	6,000	—	1500	500	—	500	400MMB473K**
	0.056	13.0	5.5	8.5	10.0	5.0/7.5/10.0	0.6	200	6,000	—	1500	500	—	500	400MMB563K**
	0.068	13.0	5.5	8.5	10.0	5.0/7.5/10.0	0.6	200	6,000	—	1000	500	—	500	400MMB683K**
	0.082	13.0	5.5	8.5	10.0	5.0/7.5/10.0	0.6	200	5,000	—	1000	500	—	500	400MMB823K**
	0.1	13.0	6.5	10.0	10.0	5.0/7.5/10.0	0.6	200	4,000	—	1000	500	—	500	400MMB104K**
	0.12	18.0	5.5	9.0	15.0	5.0/7.5/10.0/15.0	0.6	200	4,000	—	—	500	500	—	400MMB124K**
	0.15	18.0	6.0	9.0	15.0	5.0/7.5/10.0/15.0	0.6	200	4,000	—	—	500	500	—	400MMB154K**
	0.18	18.0	6.5	9.5	15.0	5.0/7.5/10.0/15.0	0.6	200	3,000	—	—	500	500	—	400MMB184K**
	0.22	18.0	6.0	13.0	15.0	5.0/7.5/10.0/15.0	0.6	100	3,000	—	—	500	500	—	400MMB224K**
	0.27	18.0	6.5	13.0	15.0	5.0/7.5/10.0/15.0	0.8	100	2,000	—	—	500	500	—	400MMB274K**
	0.33	18.0	6.5	13.5	15.0	5.0/7.5/10.0/15.0	0.8	100	2,000	—	—	500	400	—	400MMB334K**
	0.39	18.0	7.0	14.5	15.0	5.0/7.5/10.0/15.0	0.8	100	2,000	—	—	500	400	—	400MMB394K**
0.47	18.0	7.5	16.0	15.0	5.0/7.5/10.0/15.0	0.8	100	1,000	—	—	500	400	—	400MMB474K**	
0.56	25.5	6.0	15.0	22.5	15.0/22.5	0.8	200	1,000	—	—	—	—	—	400MMB564K**	
0.68	25.5	7.0	15.5	22.5	15.0/22.5	0.8	200	1,000	—	—	—	—	—	400MMB684K**	
0.82	25.5	7.0	16.5	22.5	15.0/22.5	0.8	200	1,000	—	—	—	—	—	400MMB824K**	
1	25.5	8.0	19.0	22.5	15.0/22.5	0.8	200	1,000	—	—	—	—	—	400MMB105K**	
1.2	25.5	8.5	18.5	22.5	15.0/22.5	0.8	200	800	—	—	—	—	—	400MMB125K**	
1.5	31.0	8.5	19.0	27.5	27.5	0.8	200	800	—	—	—	—	—	400MMB155K**	
1.8	31.0	9.0	20.0	27.5	27.5	0.8	100	500	—	—	—	—	—	400MMB185K**	
2.2	31.0	11.0	21.5	27.5	27.5	0.8	100	500	—	—	—	—	—	400MMB225K**	
2.7	31.0	12.0	22.0	27.5	27.5	0.8	100	500	—	—	—	—	—	400MMB275K**	
3.3	31.0	13.0	24.0	27.5	27.5	0.8	50	400	—	—	—	—	—	400MMB335K**	
3.9	31.0	14.5	25.0	27.5	27.5	0.8	50	400	—	—	—	—	—	400MMB395K**	
4.7	31.0	16.0	27.0	27.5	27.5	0.8	50	300	—	—	—	—	—	400MMB475K**	
630	0.01	13.0	5.0	8.0	10.0	5.0/7.5/10.0	0.6	200	6,000	—	1500	500	—	500	630MMB103K**
	0.012	13.0	5.5	8.0	10.0	5.0/7.5/10.0	0.6	200	6,000	—	1500	500	—	500	630MMB123K**
	0.015	13.0	5.5	8.5	10.0	5.0/7.5/10.0	0.6	200	5,000	—	1000	500	—	500	630MMB153K**
	0.018	13.0	5.5	10.0	10.0	5.0/7.5/10.0	0.6	200	5,000	—	1000	500	—	500	630MMB183K**
	0.022	13.0	5.5	10.0	10.0	5.0/7.5/10.0	0.6	200	5,000	—	1000	500	—	500	630MMB223K**
	0.027	13.0	5.5	10.5	10.0	5.0/7.5/10.0	0.6	200	5,000	—	1000	500	—	500	630MMB273K**
	0.033	13.0	6.0	11.0	10.0	5.0/7.5/10.0	0.6	200	5,000	—	1000	500	—	500	630MMB333K**
	0.039	13.0	6.0	13.0	10.0	5.0/7.5/10.0	0.6	200	4,000	—	1000	500	—	500	630MMB393K**
	0.047	13.0	7.0	13.5	10.0	5.0/7.5/10.0	0.6	200	4,000	—	1000	500	—	500	630MMB473K**
	0.056	18.0	5.5	10.5	15.0	5.0/7.5/10.0/15.0	0.6	200	4,000	—	—	500	500	—	630MMB563K**
	0.068	18.0	6.5	11.5	15.0	5.0/7.5/10.0/15.0	0.6	200	3,000	—	—	500	500	—	630MMB683K**
	0.082	18.0	6.0	11.5	15.0	5.0/7.5/10.0/15.0	0.6	100	3,000	—	—	500	500	—	630MMB823K**
	0.1	18.5	6.5	13.5	15.0	5.0/7.5/10.0/15.0	0.6	100	3,000	—	—	500	500	—	630MMB104K**
	0.12	18.5	6.5	13.5	15.0	5.0/7.5/10.0/15.0	0.8	100	2,000	—	—	500	500	—	630MMB124K**
	0.15	18.5	7.0	14.5	15.0	5.0/7.5/10.0/15.0	0.8	100	2,000	—	—	500	400	—	630MMB154K**
	0.18	18.5	7.5	15.0	15.0	5.0/7.5/10.0/15.0	0.8	100	1,000	—	—	400	400	—	630MMB184K**
	0.22	18.5	8.5	16.0	15.0	5.0/7.5/10.0/15.0	0.8	200	1,000	—	—	400	300	—	630MMB224K**
	0.27	25.5	7.0	14.5	22.5	15.0/22.5	0.8	200	1,000	—	—	—	—	—	630MMB274K**
	0.33	25.5	8.0	15.5	22.5	15.0/22.5	0.8	200	1,000	—	—	—	—	—	630MMB334K**
	0.39	25.5	9.0	17.0	22.5	15.0/22.5	0.8	200	1,000	—	—	—	—	—	630MMB394K**
0.47	25.5	9.0	18.0	22.5	15.0/22.5	0.8	200	800	—	—	—	—	—	630MMB474K**	
0.56	25.5	9.0	20.0	22.5	15.0/22.5	0.8	200	800	—	—	—	—	—	630MMB564K**	
0.68	25.5	10.5	21.0	22.5	15.0/22.5	0.8	100	500	—	—	—	—	—	630MMB684K**	
0.82	31.0	10.0	20.5	27.5	27.5	0.8	100	500	—	—	—	—	—	630MMB824K**	
1	31.0	11.5	22.5	27.5	27.5	0.8	100	500	—	—	—	—	—	630MMB105K**	
1.2	31.0	12.5	23.0	27.5	27.5	0.8	100	400	—	—	—	—	—	630MMB125K**	
1.5	31.0	14.0	25.5	27.5	27.5	0.8	50	400	—	—	—	—	—	630MMB155K**	
1.8	31.0	15.5	26.0	27.5	27.5	0.8	50	300	—	—	—	—	—	630MMB185K**	
2.2	31.0	17.0	28.0	27.5	27.5	0.8	50	300	—	—	—	—	—	630MMB225K**	

MMG series

標準品 Standard

- 自己回復性があり、信頼性が高いコンデンサです。
Reliability is excellent because these capacitors provide self-healing.
- 外装に難燃性(UL94 V-0)のエポキシ樹脂を使用していますので、安全性に優れています。
Coated with flame-retardant (UL94 V-0) epoxy resin.



◆規格表/SPECIFICATION

項目 Item	特性 Characteristics
カテゴリ温度範囲 Category Temperature Range	-40~+105°C ※
定格電圧範囲 Rated Voltage Range(U _R)	250Vdc, 450Vdc, 630Vdc
静電容量許容差 Capacitance Tolerance	±10%(K)
誘電正接 tan δ	0.01max at 1kHz
耐電圧 Voltage Proof	U _R × 150% 60s
絶縁抵抗 Insulation Resistance	C ≤ 0.33 μF: 15000M Ω min C > 0.33 μF: 5000 Ω Fmin
準拠規格 Reference Standard	JIS C 5101-2, JIS C 5101-1

※85°Cを超える範囲では使用上の注意事項に示す電圧軽減を行ってください。
Derate the voltage as shown CAUTION FOR PROPER USE OF FILM CAPACITORS when using the capacitor beyond 85°C

◆呼称方法/PART NUMBER



◆寸法図/DIMENSIONS

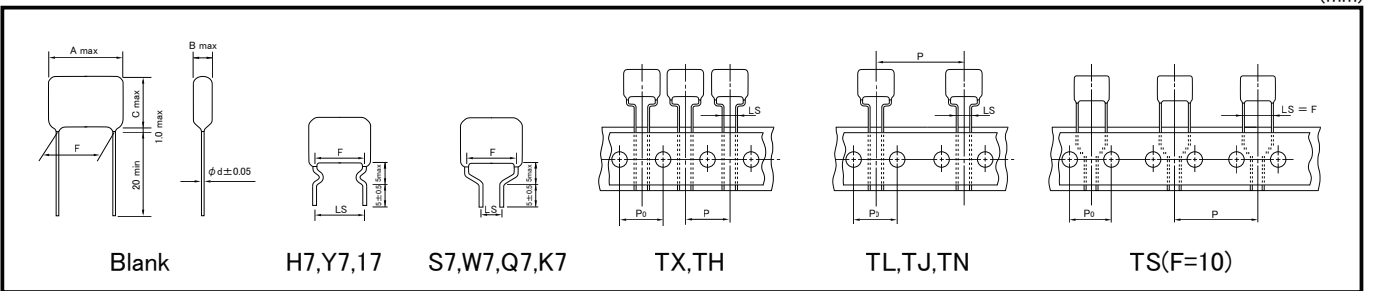

◆周波数に対する許容電流/PERMISSIBLE CURRENT FOR FREQUENCY

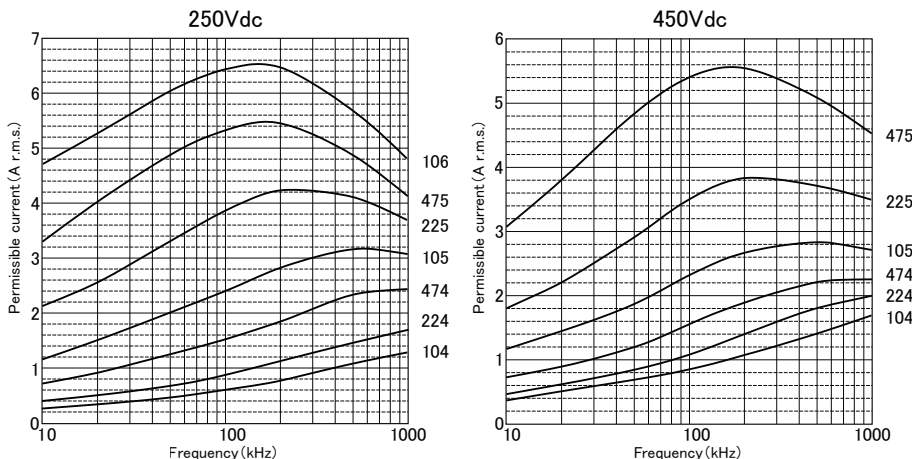

◆標準品一覧表/STANDARD SIZE

**：リード加工記号/Lead Forming

定格電圧 Rated Voltage (Vdc)	静電容量 Capacitance (μ F)	寸法 Dimensions (mm)						標準梱包数/Typical Packaging Quantity (pcs)							品番 Part No
		A	B	C	F \pm 1.0	LS \pm 0.5	d	ロングリード品 Long Lead type		テーピング(つづら)品 - 形状別 Taping Ammo Pack Type - Style					
								Bag	Carton	TC	TX,TH	TL,TJ	TN	TS	
250	0.1	13.0	6.0	12.0	10.0	5.0/7.5/10.0	0.6	200	3,000	—	1000	500	—	500	250MMG104KF1P**
	0.12	13.0	6.5	12.5	10.0	5.0/7.5/10.0	0.6	200	3,000	—	500	500	—	500	250MMG124KF1P**
	0.15	13.0	7.0	13.0	10.0	5.0/7.5/10.0	0.6	200	2,000	—	500	500	—	500	250MMG154KF1P**
	0.18	13.0	5.0	11.0	10.0	5.0/7.5/10.0	0.6	200	5,000	—	1000	500	—	500	250MMG184KF1P**
	0.22	13.0	5.5	11.5	10.0	5.0/7.5/10.0	0.6	200	5,000	—	1000	500	—	500	250MMG224KF1P**
	0.27	13.0	6.5	12.0	10.0	5.0/7.5/10.0	0.6	200	4,000	—	500	500	—	500	250MMG274KF1P**
	0.33	13.0	6.5	13.0	10.0	5.0/7.5/10.0	0.6	200	3,000	—	500	500	—	500	250MMG334KF1P**
	0.39	13.0	7.0	12.5	10.0	5.0/7.5/10.0	0.6	200	3,000	—	500	500	—	—	250MMG394K**
	0.47	13.0	7.0	14.5	10.0	5.0/7.5/10.0	0.6	100	2,000	—	500	500	—	—	250MMG474K**
	0.56	13.0	7.5	15.0	10.0	5.0/7.5/10.0	0.6	100	2,000	—	500	500	—	—	250MMG564K**
	0.68	13.0	7.5	16.5	10.0	5.0/7.5/10.0	0.6	100	2,000	—	500	500	—	—	250MMG684K**
	0.82	13.0	8.0	17.5	10.0	5.0/7.5/10.0	0.6	100	2,000	—	500	400	—	—	250MMG824K**
	1	13.0	9.5	18.0	10.0	5.0/7.5/10.0	0.6	100	1,000	—	500	400	—	—	250MMG105K**
	1.2	13.0	10.0	19.0	10.0	5.0/7.5/10.0	0.6	200	1,000	—	—	—	—	—	250MMG125K**
	1.5	13.0	10.5	20.0	10.0	5.0/7.5/10.0	0.6	200	1,000	—	—	—	—	—	250MMG155K**
	1.8	18.0	9.0	18.5	15.0	5.0/7.5/10.0/15.0	0.8	200	1,000	—	—	—	—	—	250MMG185K**
	2.2	18.0	10.5	20.0	15.0	5.0/7.5/10.0/15.0	0.8	200	1,000	—	—	—	—	—	250MMG225K**
	2.7	18.0	11.0	21.0	15.0	5.0/7.5/10.0/15.0	0.8	200	1,000	—	—	—	—	—	250MMG275K**
	3.3	18.0	12.5	22.5	15.0	5.0/7.5/10.0/15.0	0.8	200	800	—	—	—	—	—	250MMG335K**
	3.9	18.0	13.5	23.5	15.0	5.0/7.5/10.0/15.0	0.8	200	800	—	—	—	—	—	250MMG395K**
4.7	18.0	15.0	25.5	15.0	5.0/7.5/10.0/15.0	0.8	100	500	—	—	—	—	—	250MMG475K**	
5.6	25.5	12.5	24.0	22.5	15.0/22.5	0.8	100	500	—	—	—	—	—	250MMG565K**	
6.8	25.5	13.5	26.0	22.5	15.0/22.5	0.8	100	500	—	—	—	—	—	250MMG685K**	
8.2	25.5	15.5	27.0	22.5	15.0/22.5	0.8	100	500	—	—	—	—	—	250MMG825K**	
10	25.5	16.5	29.0	22.5	15.0/22.5	0.8	100	500	—	—	—	—	—	250MMG106K**	
450	0.1	13.0	7.0	13.0	10.0	5.0/7.5/10.0	0.6	100	2,000	—	500	500	—	500	450MMG104KF1P**
	0.12	13.0	5.0	10.0	10.0	5.0/7.5/10.0	0.6	200	5,000	—	1000	500	—	500	450MMG124K**
	0.15	13.0	5.5	10.0	10.0	5.0/7.5/10.0	0.6	200	5,000	—	1000	500	—	500	450MMG154K**
	0.18	13.0	6.5	10.5	10.0	5.0/7.5/10.0	0.6	200	4,000	—	1000	500	—	500	450MMG184K**
	0.22	13.0	6.5	12.0	10.0	5.0/7.5/10.0	0.6	200	4,000	—	1000	500	—	500	450MMG224K**
	0.27	13.0	6.5	14.0	10.0	5.0/7.5/10.0	0.6	200	4,000	—	1000	500	—	500	450MMG274K**
	0.33	13.0	7.5	14.5	10.0	5.0/7.5/10.0	0.6	200	3,000	—	1000	500	—	500	450MMG334K**
	0.39	13.0	8.0	15.0	10.0	5.0/7.5/10.0	0.6	100	2,000	—	500	500	—	500	450MMG394K**
	0.47	13.0	8.5	15.5	10.0	5.0/7.5/10.0	0.6	100	2,000	—	500	500	—	500	450MMG474K**
	0.56	18.0	7.0	14.0	15.0	5.0/7.5/10.0/15.0	0.6	100	2,000	—	—	500	500	—	450MMG564K**
	0.68	18.0	7.0	15.5	15.0	5.0/7.5/10.0/15.0	0.8	100	2,000	—	—	500	500	—	450MMG684K**
	0.82	18.0	7.5	16.0	15.0	5.0/7.5/10.0/15.0	0.8	100	2,000	—	—	500	400	—	450MMG824K**
	1	18.0	8.5	17.0	15.0	5.0/7.5/10.0/15.0	0.8	100	1,000	—	—	500	400	—	450MMG105K**
	1.2	18.0	8.5	19.0	15.0	5.0/7.5/10.0/15.0	0.8	200	1,000	—	—	400	400	—	450MMG125K**
	1.5	25.5	8.0	17.0	22.5	15.0/22.5	0.8	200	1,000	—	—	—	—	—	450MMG155K**
	1.8	25.5	8.5	18.0	22.5	15.0/22.5	0.8	200	1,000	—	—	—	—	—	450MMG185K**
	2.2	25.5	10.0	19.5	22.5	15.0/22.5	0.8	200	800	—	—	—	—	—	450MMG225K**
	2.7	25.5	10.5	21.5	22.5	15.0/22.5	0.8	200	800	—	—	—	—	—	450MMG275K**
	3.3	25.5	11.5	22.5	22.5	15.0/22.5	0.8	100	500	—	—	—	—	—	450MMG335K**
	3.9	25.5	12.5	23.5	22.5	15.0/22.5	0.8	100	500	—	—	—	—	—	450MMG395K**
4.7	25.5	14.5	25.5	22.5	15.0/22.5	0.8	100	500	—	—	—	—	—	450MMG475K**	

◆標準品一覧表／STANDARD SIZE

**：リード加工記号/Lead Forming

定格電圧 Rated Voltage (Vdc)	静電容量 Capacitance (μ F)	寸法 Dimensions (mm)						標準梱包数/Typical Packaging Quantity (pcs)							品番 Part No
		A	B	C	F \pm 1.0	LS \pm 0.5	d	ロングリード品 Long Lead type		テーピング(つづら)品 - 形状別 Taping Ammo Pack Type - Style					
								Bag	Carton	TC	TX,TH	TL,TJ	TN	TS	
630	0.01	この範囲はMMBシリーズ(630Vdc)をご使用下さい。 The item of this range, please select out of MMB(630Vdc) series.													
	0.012														
	0.015														
	0.018														
	0.022														
	0.027														
	0.033														
	0.039														
	0.047														
	0.056	13.0	6.0	11.0	10.0	5.0/7.5/10.0	0.6	200	4,000	—	1000	500	—	500	630MMG563K**
	0.068	13.0	6.5	11.5	10.0	5.0/7.5/10.0	0.6	200	3,000	—	500	500	—	500	630MMG683K**
	0.082	13.0	7.0	12.0	10.0	5.0/7.5/10.0	0.6	100	3,000	—	500	500	—	500	630MMG823K**
	0.1	13.0	7.0	13.5	10.0	5.0/7.5/10.0	0.6	100	2,000	—	500	500	—	500	630MMG104K**
	0.12	13.0	7.5	14.0	10.0	5.0/7.5/10.0	0.6	100	2,000	—	500	400	—	400	630MMG124K**
	0.15	13.0	8.0	14.5	10.0	5.0/7.5/10.0	0.6	100	2,000	—	500	400	—	400	630MMG154K**
	0.18	13.0	9.0	15.0	10.0	5.0/7.5/10.0	0.6	100	2,000	—	500	400	—	400	630MMG184K**
	0.22	13.0	10.5	16.5	10.0	5.0/7.5/10.0	0.6	100	1,000	—	500	400	—	400	630MMG224K**
	0.27	18.0	8.5	14.5	15.0	5.0/7.5/10.0/15.0	0.8	100	1,000	—	—	400	300	—	630MMG274K**
	0.33	18.0	9.0	15.0	15.0	5.0/7.5/10.0/15.0	0.8	100	1,000	—	—	400	300	—	630MMG334K**
	0.39	18.0	8.5	17.0	15.0	5.0/7.5/10.0/15.0	0.8	200	1,000	—	—	400	300	—	630MMG394K**
	0.47	18.0	10.0	18.0	15.0	5.0/7.5/10.0/15.0	0.8	200	1,000	—	—	300	300	—	630MMG474K**
	0.56	18.0	10.0	19.5	15.0	5.0/7.5/10.0/15.0	0.8	200	1,000	—	—	300	300	—	630MMG564K**
0.68	18.0	11.0	20.5	15.0	5.0/7.5/10.0/15.0	0.8	200	800	—	—	300	200	—	630MMG684K**	
0.82	25.5	9.0	19.5	22.5	15.0/22.5	0.8	200	800	—	—	—	—	—	630MMG824K**	
1	25.5	10.5	21.0	22.5	15.0/22.5	0.8	200	800	—	—	—	—	—	630MMG105K**	
1.2	25.5	11.0	21.5	22.5	15.0/22.5	0.8	100	500	—	—	—	—	—	630MMG125K**	
1.5	25.5	12.5	22.5	22.5	15.0/22.5	0.8	100	500	—	—	—	—	—	630MMG155K**	
1.8	25.5	14.0	24.0	22.5	15.0/22.5	0.8	100	500	—	—	—	—	—	630MMG185K**	
2.2	25.5	15.5	26.0	22.5	15.0/22.5	0.8	100	500	—	—	—	—	—	630MMG225K**	

◆周波数に対する許容電流／PERMISSIBLE CURRENT FOR FREQUENCY

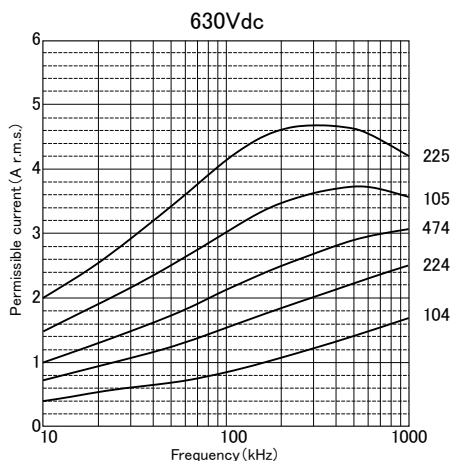

MMBA series

交流雑音防止用
Across-the-line

- 自己回復性があり、信頼性が高いコンデンサです。
Reliability is excellent because these capacitors provide self-healing.
- 外装に難燃性(UL94 V-0)のエポキシ樹脂を使用していますので、安全性に優れています。
Coated with flame-retardant (UL94 V-0) epoxy resin.



◆規格表/SPECIFICATION

項目 Item	特性 Characteristics
カテゴリ温度範囲 Category Temperature Range	-40~+85°C
定格電圧範囲 Rated Voltage Range(U _R)	125Vac, 250Vac
静電容量許容差 Capacitance Tolerance	±10%(K)
誘電正接 tan δ	0.001max at 1kHz
耐電圧 Voltage Proof	U _R × 230% 60s
絶縁抵抗 Insulation Resistance	125Vac C ≤ 0.33 μF: 9000MΩ min C > 0.33 μF: 3000Ω F min 250Vac 2000MΩ min
準拠規格 Reference Standard	JIS C 5101-1

◆呼称方法/PART NUMBER

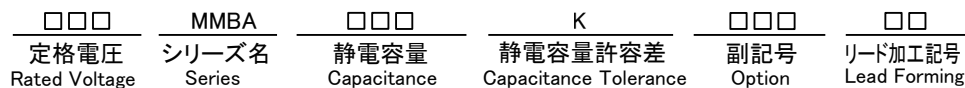

◆寸法図/DIMENSIONS

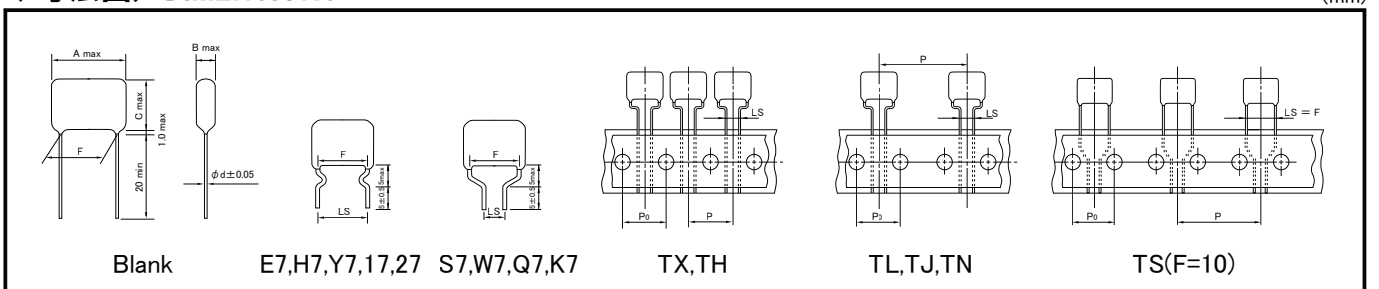

- 注) 1. 接続条件 (Fig.1, Fig.2)
2. 雑音防止用として使用の場合、パルス電圧はTable 1の値以下として下さい。

- Note) 1. Operating circuit (Fig.1, Fig.2)
2. When operating capacitor for noise suppression, voltage of pulse applied to the capacitor shall be within value specified in Table 1.

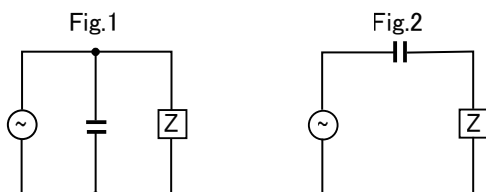

定格電圧 Rated Voltage	パルス電圧 Pulse Voltage
125Vac	250Vo-p
250Vac	630Vo-p

◆標準品一覧表/STANDARD SIZE

**：リード加工記号/Lead Forming

定格電圧 Rated Voltage (Vac)	静電容量 Capacitance (μ F)	寸法 Dimensions (mm)						標準梱包数/Typical Packaging Quantity (pcs)							品番 Part No
		A	B	C	F \pm 1.0	LS \pm 0.5	d	ロングリード品 Long Lead type		テーピング(つづら)品 - 形状別 Taping Ammo Pack Type - Style					
								Bag	Carton	TC	TX,TH	TL,TJ	TN	TS	
125	0.01	10.0	5.5	9.5	7.5	5.0/7.5	0.6	200	6,000	1000	-	-	-	1000	125MMBA103K**
	0.012	10.0	5.5	9.5	7.5	5.0/7.5	0.6	200	6,000	1000	-	-	-	1000	125MMBA123K**
	0.015	10.0	5.5	9.5	7.5	5.0/7.5	0.6	200	6,000	1000	-	-	-	1000	125MMBA153K**
	0.018	10.0	5.5	9.5	7.5	5.0/7.5	0.6	200	6,000	1000	-	-	-	1000	125MMBA183K**
	0.022	10.0	5.5	9.5	7.5	5.0/7.5	0.6	200	6,000	1000	-	-	-	1000	125MMBA223K**
	0.027	10.0	5.5	9.5	7.5	5.0/7.5	0.6	200	6,000	1000	-	-	-	1000	125MMBA273K**
	0.033	10.0	5.5	9.5	7.5	5.0/7.5	0.6	200	6,000	1000	-	-	-	1000	125MMBA333K**
	0.039	10.0	5.5	10.0	7.5	5.0/7.5	0.6	200	5,000	1000	-	-	-	1000	125MMBA393K**
	0.047	10.0	6.0	10.5	7.5	5.0/7.5	0.6	200	5,000	1000	-	-	-	1000	125MMBA473K**
	0.056	10.0	6.0	11.0	7.5	5.0/7.5	0.6	200	4,000	1000	-	-	-	1000	125MMBA563K**
	0.068	10.0	6.0	12.5	7.5	5.0/7.5	0.6	200	4,000	1000	-	-	-	1000	125MMBA683K**
	0.082	10.0	6.5	13.0	7.5	5.0/7.5	0.6	200	4,000	1000	-	-	-	1000	125MMBA823K**
	0.1	10.0	6.0	9.0	7.5	5.0/7.5	0.5	200	6,000	1000	-	-	-	1000	125MMBA104K**
	0.12	10.0	6.0	9.0	7.5	5.0/7.5	0.5	200	6,000	1000	-	-	-	1000	125MMBA124K**
	0.15	10.0	6.5	10.0	7.5	5.0/7.5	0.5	200	5,000	1000	-	-	-	1000	125MMBA154K**
	0.18	10.0	6.5	11.0	7.5	5.0/7.5	0.5	200	5,000	1000	-	-	-	1000	125MMBA184K**
	0.22	10.0	7.0	12.0	7.5	5.0/7.5	0.5	200	4,000	1000	-	-	-	1000	125MMBA224K**
	0.27	13.0	6.0	11.5	10.0	5.0/7.5/10.0	0.6	200	4,000	-	1000	500	-	500	125MMBA274K**
	0.33	13.0	6.5	12.0	10.0	5.0/7.5/10.0	0.6	200	3,000	-	1000	500	-	500	125MMBA334K**
	0.39	13.0	7.0	12.5	10.0	5.0/7.5/10.0	0.6	200	3,000	-	500	500	-	500	125MMBA394K**
0.47	13.0	8.0	13.5	10.0	5.0/7.5/10.0	0.6	100	2,000	-	500	500	-	500	125MMBA474K**	
0.56	13.0	8.0	15.0	10.0	5.0/7.5/10.0	0.6	100	2,000	-	500	400	-	400	125MMBA564K**	
0.68	13.0	8.5	15.5	10.0	5.0/7.5/10.0	0.6	100	2,000	-	500	400	-	400	125MMBA684K**	
0.82	18.0	7.5	14.0	15.0	5.0/7.5/10.0/15.0	0.6	100	2,000	-	-	400	400	-	125MMBA824K**	
1	18.0	8.0	15.5	15.0	5.0/7.5/10.0/15.0	0.6	100	1,500	-	-	400	400	-	125MMBA105K**	
250	0.01	13.0	5.0	9.0	10.0	5.0/7.5/10.0	0.6	200	5,000	-	1000	500	-	500	250MMBA103K**
	0.012	13.0	5.5	9.5	10.0	5.0/7.5/10.0	0.6	200	5,000	-	1000	500	-	500	250MMBA123K**
	0.015	13.0	6.5	10.5	10.0	5.0/7.5/10.0	0.6	200	4,000	-	1000	500	-	500	250MMBA153K**
	0.018	13.0	6.5	10.5	10.0	5.0/7.5/10.0	0.6	200	4,000	-	1000	500	-	500	250MMBA183K**
	0.022	13.0	6.0	9.5	10.0	5.0/7.5/10.0	0.6	200	4,000	-	1000	500	-	500	250MMBA223K**
	0.027	13.0	5.5	11.0	10.0	5.0/7.5/10.0	0.6	200	4,000	-	1000	500	-	500	250MMBA273K**
	0.033	13.0	5.5	11.0	10.0	5.0/7.5/10.0	0.6	200	4,000	-	1000	500	-	500	250MMBA333K**
	0.039	13.0	6.0	11.5	10.0	5.0/7.5/10.0	0.6	200	4,000	-	1000	500	-	500	250MMBA393K**
	0.047	13.0	7.0	12.0	10.0	5.0/7.5/10.0	0.6	200	3,000	-	1000	500	-	500	250MMBA473K**
	0.056	18.0	5.5	11.0	15.0	5.0/7.5/10.0/15.0	0.6	200	3,000	-	-	500	400	-	250MMBA563K**
	0.068	18.0	6.0	11.0	15.0	5.0/7.5/10.0/15.0	0.6	100	3,000	-	-	500	400	-	250MMBA683K**
	0.082	18.0	6.5	11.5	15.0	5.0/7.5/10.0/15.0	0.6	100	3,000	-	-	500	400	-	250MMBA823K**
	0.1	18.0	6.5	13.5	15.0	5.0/7.5/10.0/15.0	0.6	100	2,000	-	-	500	400	-	250MMBA104K**
	0.12	18.0	7.0	13.5	15.0	5.0/7.5/10.0/15.0	0.8	100	2,000	-	-	500	400	-	250MMBA124K**
	0.15	18.0	7.5	14.5	15.0	5.0/7.5/10.0/15.0	0.8	100	1,500	-	-	400	400	-	250MMBA154K**
	0.18	18.0	8.0	15.0	15.0	5.0/7.5/10.0/15.0	0.8	100	1,500	-	-	400	400	-	250MMBA184K**
	0.22	18.5	9.0	15.5	15.0	5.0/7.5/10.0/15.0	0.8	100	1,500	-	-	400	300	-	250MMBA224K**
	0.27	25.5	7.0	16.0	22.5	15.0/22.5	0.8	50	1,500	-	-	-	-	-	250MMBA274K**
	0.33	25.5	8.0	16.5	22.5	15.0/22.5	0.8	200	1,000	-	-	-	-	-	250MMBA334K**
	0.39	25.5	8.5	17.0	22.5	15.0/22.5	0.8	200	1,000	-	-	-	-	-	250MMBA394K**
0.47	25.5	9.5	18.0	22.5	15.0/22.5	0.8	200	800	-	-	-	-	-	250MMBA474K**	
0.56	25.5	9.5	20.0	22.5	15.0/22.5	0.8	200	800	-	-	-	-	-	250MMBA564K**	
0.68	25.5	10.5	21.0	22.5	15.0/22.5	0.8	100	500	-	-	-	-	-	250MMBA684K**	
0.82	31.0	10.0	20.5	27.5	27.5	0.8	100	500	-	-	-	-	-	250MMBA824K**	
1	31.0	11.0	22.0	27.5	27.5	0.8	100	500	-	-	-	-	-	250MMBA105K**	

MCRA-DP series

サージアブソーバ Surge Absorber

- ・コンデンサと抵抗器を複合したサージアブソーバで、リレーやスイッチ等のサージ電圧吸収、接点保護に最適です。
Suitable for absorbing surge voltage and protecting contact of relay and switch, etc.
- ・外装に難燃性(UL94 V-0)のエポキシ樹脂を使用していますので、安全性に優れています。
Coated with flame-retardant (UL94 V-0) epoxy resin.

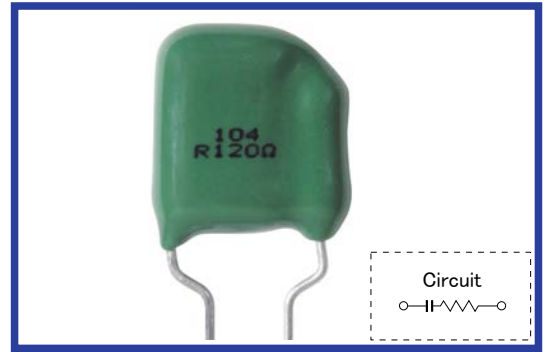

◆規格表/SPECIFICATION

項目 Item	特性 Characteristics
カテゴリ温度範囲 Category Temperature Range	-25~+85°C
定格電圧範囲 Rated Voltage Range(U _R)	125Vac, 250Vac
静電容量許容差 Capacitance Tolerance	±20%(M)
抵抗値許容差 Resistance Tolerance	±10%(K)
耐電圧 Voltage Proof	U _R × 230% 60s
絶縁抵抗 Insulation Resistance	2000MΩ min
準拠規格 Reference Standard	電気用品安全法

◆呼称方法/PART NUMBER



◆寸法図/DIMENSIONS

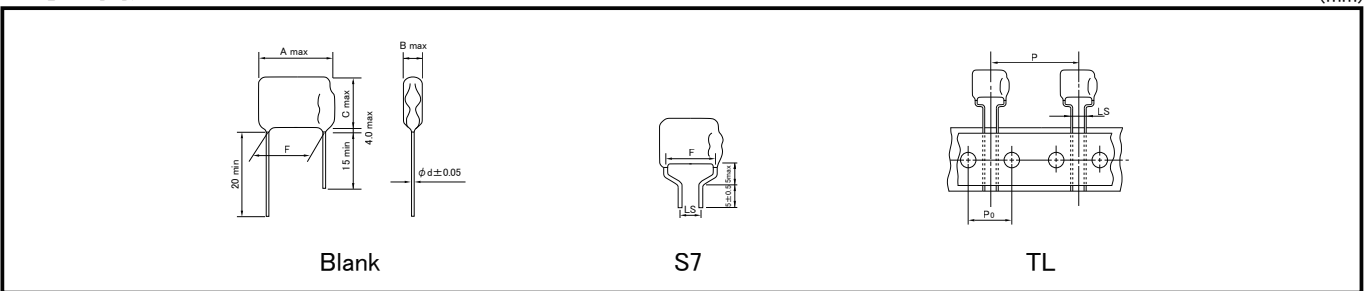

◆標準品一覧表/STANDARD SIZE

**：リード加工記号/Lead Forming

定格電圧 Rated Voltage (Vac)	静電容量 Capacitance (μF) ※	抵抗値 R (Ω) ※	寸法 Dimensions (mm)						標準梱包数/Typical Packaging Quantity (pcs)					品番 Part No	
			A	B	C	F±1.5	LS±0.5	d	ロングリード品 Long Lead type		テーピング(つづら)品 - 形状別 Taping Ammo Pack Type - Style				
									Bag	Carton	TC	TX,TH	TL,TJ		TN
125	0.033	47	14.0	6.5	16.0	8.5	5.0	0.7	200	3000	-	-	500	-	125MCRA333047MDP**B0918
	0.033	120	14.5	6.5	16.0	8.5	5.0	0.7	200	3000	-	-	500	-	125MCRA333120MDP**B0891
	0.1	47	15.5	6.5	16.0	10.0	5.0	0.7	200	3000	-	-	500	-	125MCRA104047MDP**B0901
	0.1	120	15.5	7.0	16.0	10.0	5.0	0.7	200	3000	-	-	500	-	125MCRA104120MDP**B0768
250	0.033	47	15.5	7.0	17.0	10.0	5.0	0.7	200	3000	-	-	500	-	250MCRA333047MDP**B0853
	0.033	120	15.5	7.0	17.0	10.0	5.0	0.7	200	3000	-	-	500	-	250MCRA333120MDP**B0915
	0.1	47	17.0	8.5	17.5	12.0	5.0	0.7	100	2000	-	-	400	-	250MCRA104047MDP**B1139
	0.1	120	17.0	8.5	17.5	12.0	5.0	0.7	100	2000	-	-	400	-	250MCRA104120MDP**B0850

※CとRの組合せについては、カスタム設計にて対応します。 / The combination of C and R respond to custom design.

PMLCAPの使用上の注意事項

PMLCAPのご使用に際しては下記の点にご留意
頂くようお願い致します。

なお、カタログ掲載の内容について予告なく変更
する場合がありますので、予めご了承ください。

1. 印加電圧

1) 定格電圧

コンデンサに印加される電圧は、直流電圧と交流電
圧の和の尖頭値を直流定格電圧以下にしてくだ
さい。

2) 使用温度による定格電圧軽減

本コンデンサは、カテゴリ温度範囲内の定格電
圧軽減は必要ありません。

3) 高周波で使用する場合

コンデンサを高周波で使用すると自己発熱によりコ
ンデンサ寿命が低下します。高周波で使用される場
合は、お問い合わせください。

4) 特殊波形で使用する場合

正弦波以外の特殊波形で使用する場合は、実効値
がそれぞれ異なりますので、詳細は電流波形を
ご確認の上、お問い合わせください。

2. 静電容量許容差の保証について

PMLCAPは、周囲の環境条件によって特性が変化す
る場合があります。自然放置の状態においても、吸湿に
より多少の容量変化が起こります。このような容量変化
を考慮して出荷しておりますが、静電容量許容差の保
証はアルミニウム防湿袋の初回開封時までとさせて頂
きます。なお、個別の取り交わしがある場合は、この限
りではありません。

3. 許容電流

1) 周波数に対する許容電流

事前にお問い合わせください。

2) 許容ピーク電流値(パルス電流)

正弦波以外の特殊波形で使用する場合は、実効値が
それぞれ異なりますので、詳細は電流波形をご確認
の上、お問い合わせください。

4. 自己温度上昇

自己温度上昇は10°C以内としてください。

CAUTION FOR PROPER USE OF PMLCAP

Upon using PMLCAP, please pay attention to
the points listed below.

Catalog may be subject to change without
notice.

1. APPLIED VOLTAGE

1) Rated voltage

As for applied voltage to capacitors, sum of DC
voltage and peak AC voltage should not exceed
their own DC rated voltage.

2) Voltage derating

Within category temperature range, capacitors can be
used without voltage derating.

3) Use in high frequency

Using capacitors at high frequency will be shortened
its life due to the generation of heat. Please consult
us in this case.

4) Use in special wave-form

If you want to use capacitors with a special wave-
form other than a sine wave, please inquire to us
for details after identifying the wave-form with
which the capacitor is required to be used, because
the effective value varies with wave-form.

2. GUARANTEE OF CAPACITANCE TOLERANCE

PMLCAP characteristics may fluctuate by
surroundings. Even if left in natural condition,
capacitance may fluctuate by humidity.

By considering it, the product shall be shipped with
special care at factory.

But the guarantee of capacitance tolerance shall be
applied once before opening the humidity proof bag. It
shall not be applied when individual agreement is
exchanged.

3. PERMISSIBLE CURRENT

1) Permissible current for frequency

Please contact us in advance.

2) Permissible peak current (pulse current)

If you want to use capacitors with a special wave-
form other than a sine wave, please inquire to us
for details after identifying the wave-form with
which the capacitor is required to be used,
because the effective value varies with wave-form.

4. SELF HEAT RISE

Please confirm self heat rise within 10°C.

5. 使用温度について

使用温度は、仕様書の範囲内としてください。仕様書に規定する温度範囲を超えて使用されますと、特性の劣化や故障の原因となります。

使用温度については、機器に組み込まれる発熱体(トランジスタ、抵抗など)による放射熱及びリップル電流によるコンデンサの自己発熱にもご注意ください。

6. 基板への実装について

1) 実装方法

PMLCAP MU/MS/NS/MHシリーズは リフロー、フロー実装兼用です。
VPS法等の実装は行わないでください。

2)MSL

IPC/JEDEC J-STD-020E に基づく
MSL (Moisture Sensitive Level) は下表の通りです。

Chip Size	1608	2012	3216	3225	4532	5750	8271	1632	3245
MSL	3	3	3	4	5	5	5	4	5
Floor life time* (hours)	168	168	168	96	48	48	48	72	48

※フロアライフは、30°C60%RH以下で防湿管理した場合です。/Floor life time is the case of humidity control under 30°C60%RH.

3) クリームはんだ(面実装品)

塗布厚みは0.1~0.2mmが適切です。また、ハロゲン活性剤の含有率が0.1%以下のクリームはんだをご使用ください。

4) 仮実装(面実装品)

仮実装にて両面テープを使用した場合には、本製品の再使用はできません。

5) はんだコテの使用について

はんだコテでの実装が必要な場合は下記の条件ではんだ付けをお願いします。

項目 Items	条件 Conditions
コテ先温度 Temperature	350°C以下 350°C Max
はんだ付け時間 Time	4秒以内 4 seconds Max
はんだコテ容量 Power	30W以下 30W Max
その他 Other	予備加熱無し No preheat

- ・はんだコテによるはんだ付けは、1回までとしてください。
- ・実装後のはんだコテによる手直しも、上記条件をお願いします。
- ・はんだコテをコンデンサ本体に当てないでください。コンデンサ本体に触れた場合、絶縁抵抗低下等の特性劣化を起こす可能性があります。
- ・一旦基板からはずしたコンデンサは、再使用しないでください。
- ・上記条件以外ではんだ付けされる場合は、お問い合わせください。

5. OPERATING TEMPERATURE

Use capacitors within the specified temperature range. If used outside the specified temperature range, then the electrical characteristics may deteriorate significantly, leading to failure.

The temperature referred to here includes the ambient temperature including heat produced by heat generating devices (power transistors, resistors, etc.), self heating due to ripple current.

6. SOLDERING

1) Soldering method

MU/MS/NS/MH series shall be used in reflow soldering and flow soldering method.
Do not use in VPS soldering method.

2)MSL

Moisture Sensitive Level (MSL) which is based on IPC/JEDEC J-STD-020E is showed in the following table.

3) Solder paste (Chip type)

A recommended thickness of solder paste is between 0.1mm to 0.2mm.
The content of halogen in the soldering flux should be 0.1wt% or less.

4) Tentative mounting (Chip type)

This product can not be used again when the double-stick tape is used for tentative mounting.

5) Using soldering iron

Please refer to the following conditions if soldering by iron is necessary.

- ・Soldering under above conditions should not be repeated for a same part.
- ・Please keep above conditions when reworking is need after reflow soldering.
- ・Do not hit the tip of soldering iron to the capacitor directly.
- ・Do not reuse the capacitor.
- ・Please contact us in advance if your condition is different with above.

7. 洗浄について

コンデンサ実装後に基板洗浄を行う場合、洗浄液ならびに超音波の影響によりコンデンサ性能が劣化する恐れがありますので、事前にお問い合わせください。

8. 保管条件

MUシリーズ・MSシリーズ：保管条件及び使用期限は、アルミニウム防湿袋未開封の状態です。常温常湿（5～30℃、70%RH以下）の条件下で、出荷後1年以内です。

防湿袋開封後、乾燥したシリカゲルとともに防湿袋のチャックを密閉した状態で保管した場合の使用期限は、開封後から1ヶ月以内です（気温：5℃～30℃、湿度：70%RH以下）。

ただし、周囲環境の湿度が5%RH以下で保管する場合は未開封状態として取り扱うことができます。

9. 使用環境の制限

コンデンサは、次の環境では、使用しないでください。

- ①直接水、食塩水及び油がかかったり、又は結露状態になる環境
- ②有害ガス（硫化水素、亜硫酸、亜硝酸、塩素、アンモニア、臭素など）が充満する環境
- ③オゾン、紫外線及び放射線が照射される環境

10. 廃棄の場合

コンデンサを廃棄する場合は専門の産業廃棄物処理業者に依頼してください。

7. CLEANING SOLVENTS

Please contact us in advance when cleaning of the PC board after soldering is necessary. If used improper cleaning agent and/or ultrasonic, the capacitor may be damaged.

8. STORAGE CONDITION

MU series/MS series storage time limit is within 1 year from shipping date without opening of moisture-proof bag under the normal temperature (5~30°C) and normal humidity (70%RH or less)

After opening of moisture-proof bag, storage time limit (the state that a zipper of a moisture-proof bag was closed with dry silica gel) is within 1 month (Temperature: 5~30°C, Relative humidity: 70% or less). But, when the humidity of the ambient environment keeps below 5%RH, it's possible to treat as the unopened position of moisture proof bag.

9. CONDITION OF USE

The following environment should be avoided when using capacitors.

- ①Damp conditions such as water, saltwater spray, or oil spray or fumes. High humidity or humidity condensation situations.
- ②Hazardous gas/fumes (hydrogen sulfide, sulfuric acid, nitrous acid, chlorine, ammonia, bromine, etc.)
- ③Exposure to ozone, ultraviolet rays or radiation

10. DISPOSAL

In case of rejecting capacitors, please seek for professionals who deal with the industrial wastes management.

◆キャリアテープ寸法／CARRIER TAPE DIMENSIONS

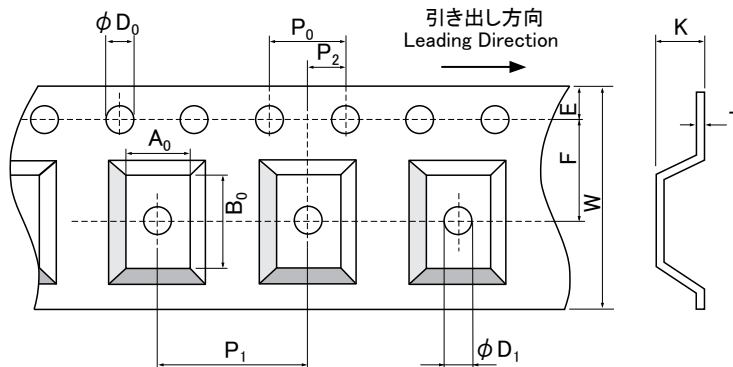

チップサイズ Chip Size	コード Taping code	寸法 Dimensions											
		A ₀ ±0.1	B ₀ ±0.1	W ±0.2	F ±0.05	E ±0.1	P ₁ ±0.1	P ₂ ±0.05	P ₀ ±0.1	φD ₀ ±0.1	φD ₁ +0.2/-0	K ±0.1	T ±0.05
1608	Y 1	1.1	1.9	8.0	3.5	1.75	4.0	2.0	4.0	1.5	—	0.8	0.20
2012	Z 1	1.45	2.25	8.0	3.5	1.75	4.0	2.0	4.0	1.5	1.0	1.0	0.25
	Z 2											1.3	0.25
3216	A 1	1.9	3.5	8.0	3.5	1.75	4.0	2.0	4.0	1.5	1.1	1.4	0.30
	A 2											1.8	0.30
3225	B 1	2.8	3.5	8.0	3.5	1.75	4.0	2.0	4.0	1.5	1.0	1.8	0.30
	B 2											2.2	0.30
	B 3											2.4	0.30
4532 3245	C 1	3.6	4.9	12.0	5.5	1.75	8.0	2.0	4.0	1.5	1.5	1.8	0.30
	C 2											2.2	0.30
	C 3											2.4	0.30
	C 4											3.0	0.30
5750	D 1	5.3	6.0	12.0	5.5	1.75	8.0	2.0	4.0	1.5	1.6	2.2	0.30
	D 2											2.6	0.30
	D 3											3.0	0.30
8271	F 2	7.5	8.6	16.0	7.5	1.75	12.0	2.0	4.0	1.5	1.5	2.9	0.33

◆リール寸法／REEL DIMENSIONS

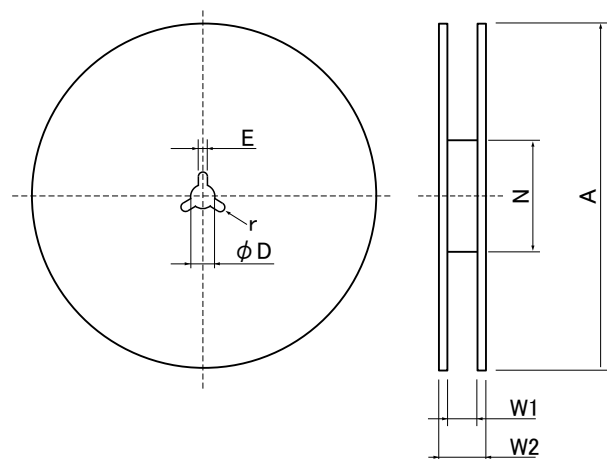

チップサイズ Chip Size	コード Taping code	リールサイズ Reel size	梱包数量 Quantity / Reel
1608	Y 1	φ 180mm	4,000pcs
2012	Z 1,Z 2	φ 180mm	3,000pcs
3216	A 1	φ 180mm	3,000pcs
	A 2	φ 180mm	2,000pcs
3225	B 1,B 2,B 3	φ 180mm	2,000pcs
4532 3245	C 1,C 2	φ 180mm	1,000pcs
	C 3,C 4	φ 180mm	500pcs
5750	D 1,D 2	φ 180mm	1,000pcs
	D 3	φ 180mm	500pcs
8271	F 2	φ 180mm	400pcs

コード Taping code	寸法 Dimensions						
	A ±1.0	N ±1.0	W1 ±1.0	W2 ±1.0	φD ±0.2	E ±0.5	r ±0.2
Y, Z, A, B	180	60	9.5	13.1	13.0	2.0	1.0
C, D	180	60	13.5	18.5	13.0	2.0	1.0
F	180	60	17.0	19.4	13.0	2.0	1.0

●基板実装条件/SOLDERING CONDITIONS

◆リフロー条件/REFLOW SOLDERING CONDITION

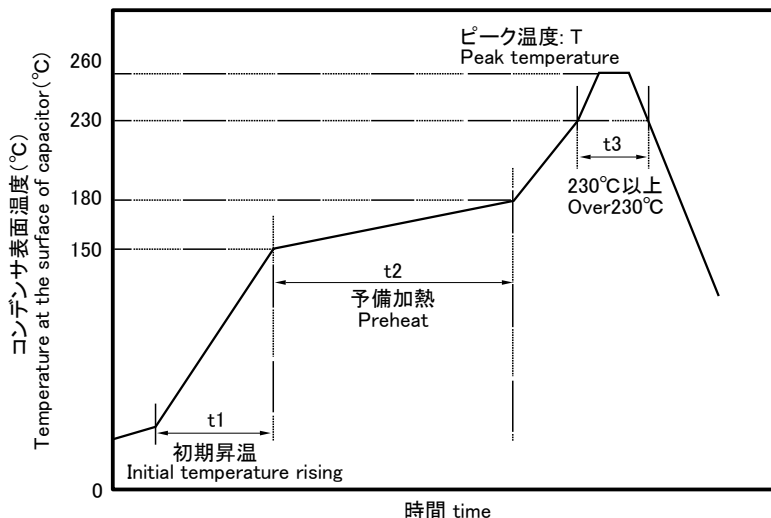

初期昇温区間 : t1 Period of initial temperature rising	予備加熱区間 : t2 Period of preheat	230°C以上区間 : t3 Period over 230°C	ピーク温度 : T Peak temperature
常温 (room temperature) ~150°C 3°C/ sec MAX	150~180°C 60~120 sec	30~60 sec	260°C MAX

※温度測定位置は、コンデンサ積層体表面とする。Temperature is measured at the surface of capacitor.

- 1) ピーク温度での滞留は極力短くしてください。
Holding time at the peak temperature should be as short as possible.
- 2) リフローの繰り返し回数は2回までとし、2回目のリフローはコンデンサ温度が常温に戻ってから行ってください。
Reflow soldering cycle is limited to two (2). The second soldering should be done after the capacitor itself has returned to room temperature.
- 3) 推奨温度プロファイルとは異なる条件でリフロー実装を行う場合には、事前にお問い合わせください。
Please consult us in advance if your reflow soldering condition is different from recommended condition.

◆フロー条件/FLOW SOLDERING CONDITION

フロー条件についてはお問い合わせください。
Please consult us about flow soldering condition.

◆推奨ランドパターン/RECOMENDED LAND PATTERN

コンデンサ実装用のランド寸法は、極力下表の設計値をご使用ください。
但し、フロー実装の場合にはB寸法を下表よりも0.4~0.6mm程度大きくしてください。
ランド設計値が推奨値と大幅に異なる場合は、事前にお問い合わせください。
For designing land size, refer to the following recommended land size.
However, in flow soldering, please enlarge B dimension about 0.4 to 0.6 mm.
Please consult us in advance if your land design is vastly different from recommended land size.

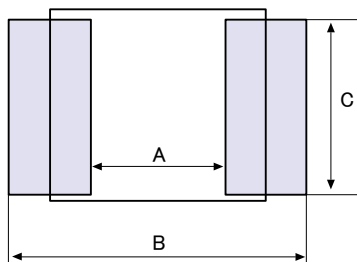

チップサイズ Chip Size	ランド寸法記号(mm) Dimensions		
	A	B	C
1608	0.5	2.0	0.7
2012	0.8	2.4	1.1
3216	1.8	3.6	1.4
3225	1.8	3.6	2.3
4532	2.7	5.7	3.0
5750	3.5	7.8	4.5
8271	6.3	10.1	6.5
3245	1.8	3.6	4.1

MU series

標準品
Standard

- ・面実装品。Surface-mounted device.
- ・無極性コンデンサ Non-polar capacitor.
- ・鉛フリーフローはんだ付けが可能。Lead free reflow soldering is available.
- ・フローはんだ付けが可能。Flow soldering is available.

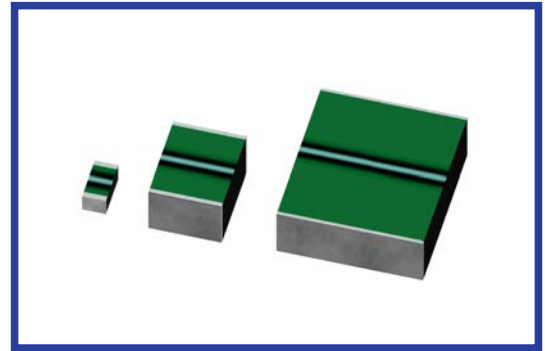

◆規格表/SPECIFICATIONS

項目 Item	特性 Characteristics		
カテゴリ温度範囲 Category Temperature Range	-55~+125°C		
定格電圧範囲 Rated Voltage Range	16~63Vdc	100Vdc	200Vdc
静電容量範囲 Capacitance Range	0.0001~22 μF (101~226)	0.001~0.1 μF (102~104)	0.0001~0.1 μF (101~104)
静電容量許容差 Capacitance Tolerance	±10% (K), ±20% (M)		±20% (M)
損失角の正接 (tan δ) Dissipation Factor (MAX)	1.5%以下 (1kHz±20%, 5Vrms以下) 1.5% or less (1kHz±20%, 5Vrms or less)		
耐電圧 Voltage Proof	定格電圧の150%を1分間または175%を1~5秒間印加後、異常の無いこと。 Nothing abnormal shall be found, when applying 150% of the rated voltage for 1 minute or 175% of the rated voltage for 1 second to 5 seconds.		定格電圧の130%を1~5秒間印加後、異常の無いこと。 Nothing abnormal shall be found, when applying 130% of the rated voltage for 1 second to 5 second
絶縁抵抗 Insulation Resistance	C ≤ 0.1 μF: 3000MΩ 以上 (定格電圧印加1分後) C ≤ 0.1 μF: 3000MΩ or more (After 1 minute application of rated voltage) C > 0.1 μF: 300MΩ · μF 以上 (定格電圧印加1分後) C > 0.1 μF: 300MΩ · μF or more (After 1 minute application of rated voltage)		1000MΩ 以上 (定格電圧印加1分後) 1000MΩ or more (After 1 minute application of rated voltage)

◆呼称方法/PART NUMBER



記号 Code	定格電圧 Rated Voltage
16	16Vdc
25	25Vdc
35	35Vdc
50	50Vdc
63	63Vdc
100	100Vdc
200	200Vdc

記号 Code	静電容量 Capacitance
101	0.0001 μF
682	0.0068 μF
153	0.015 μF
224	0.22 μF
335	3.3 μF
226	22 μF

記号 Code	許容差 Tolerance
K	±10%
M	±20%

記号 Code	チップサイズ Chip Size
1608	1.6x0.8mm
2012	2.0x1.25mm
3216	3.2x1.6mm
3225	3.2x2.5mm
4532	4.5x3.2mm
5750	5.7x5.0mm
3245	3.2x4.5mm

◆周波数に対する許容電流/PERMISSIBLE CURRENT FOR FREQUENCY

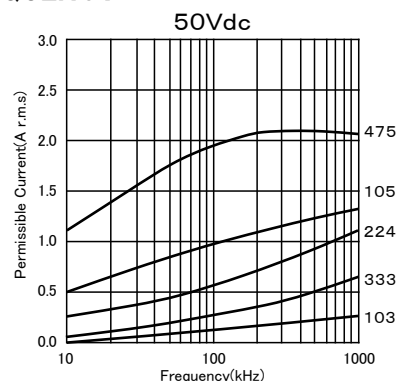
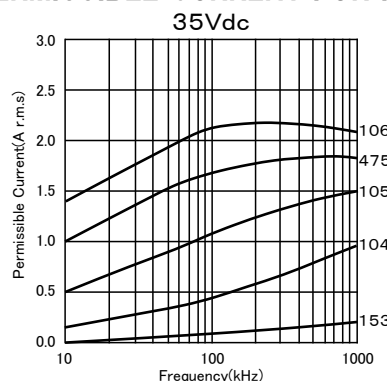
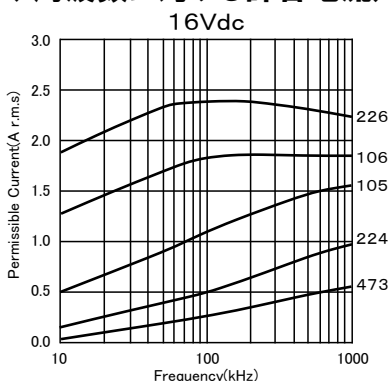

◆標準品一覧表／STANDARD SIZE

□: 静電容量許容差記号 / Tolerance

定格電圧 Rated Voltage (Vdc)	静電容量 Capacitance (μ F)	外形寸法 Size (mm)			品番 Part No.
		L	W	H	
16	0.047	1.6	0.8	0.65	16MU473□Y11608
	0.15	2.0	1.25	1.0	16MU154□Z22012
	0.22	2.0	1.25	1.0	16MU224□Z22012
	1.0	3.2	1.6	1.4	16MU105□A23216
	1.5	3.2	1.6	1.4	16MU155□A23216
	2.2	3.2	2.5	1.8	16MU225□B23225
	3.3	3.2	2.5	2.0	16MU335□B33225
	4.7	4.5	3.2	1.4	16MU475□C14532
	6.8	4.5	3.2	1.8	16MU685□C24532
	10	4.5	3.2	2.6	16MU106□C44532
	15	5.7	5.0	1.8	16MU156□D15750
	22	5.7	5.0	2.6	16MU226□D35750
25	0.033	1.6	0.8	0.65	25MU333□Y11608
	0.10	2.0	1.25	1.0	25MU104□Z22012
	0.15	2.0	1.25	1.0	25MU154□Z22012
	0.68	3.2	1.6	1.4	25MU684□A23216
	1.0	3.2	1.6	1.4	25MU105□A23216
	1.5	3.2	2.5	2.0	25MU155□B33225
	2.2	3.2	2.5	1.8	25MU225□B23225
	3.3	4.5	3.2	1.4	25MU335□C14532
	4.7	4.5	3.2	1.8	25MU475□C24532
	6.8	4.5	3.2	2.6	25MU685□C44532
	10	5.7	5.0	1.8	25MU106□D15750
	15	5.7	5.0	2.6	25MU156□D35750
35	0.015	1.6	0.8	0.65	35MU153□Y11608
	0.022	1.6	0.8	0.65	35MU223□Y11608
	0.047	2.0	1.25	1.0	35MU473□Z22012
	0.068	2.0	1.25	0.8	35MU683□Z12012
	0.10	2.0	1.25	1.0	35MU104□Z22012
	0.47	3.2	1.6	1.0	35MU474□A13216
	0.68	3.2	1.6	1.4	35MU684□A23216
	1.0	3.2	2.5	1.4	35MU105□B13225
	1.5	3.2	2.5	2.0	35MU155□B33225
	2.2	4.5	3.2	1.4	35MU225□C14532
	3.3	4.5	3.2	1.8	35MU335□C24532
	4.7	4.5	3.2	2.6	35MU475□C44532
6.8	5.7	5.0	1.8	35MU685□D15750	
10	5.7	5.0	2.6	35MU106□D35750	
50	0.00010	1.6	0.8	0.65	50MU101□Y11608
	0.00015	1.6	0.8	0.65	50MU151□Y11608
	0.00022	1.6	0.8	0.65	50MU221□Y11608
	0.00033	1.6	0.8	0.65	50MU331□Y11608
	0.00047	1.6	0.8	0.65	50MU471□Y11608
	0.00068	1.6	0.8	0.65	50MU681□Y11608
	0.0010	1.6	0.8	0.65	50MU102□Y11608
	0.0015	1.6	0.8	0.65	50MU152□Y11608
	0.0022	1.6	0.8	0.65	50MU222□Y11608
	0.0033	1.6	0.8	0.65	50MU332□Y11608
	0.0047	1.6	0.8	0.65	50MU472□Y11608
	0.0068	1.6	0.8	0.65	50MU682□Y11608
0.010	1.6	0.8	0.65	50MU103□Y11608	
0.033	2.0	1.25	1.0	50MU333□Z22012	
0.047	2.0	1.25	1.0	50MU473□Z22012	
0.10	3.2	1.6	1.0	50MU104□A13216	
0.15	3.2	1.6	1.0	50MU154□A13216	
0.22	3.2	1.6	1.0	50MU224□A13216	
0.33	3.2	1.6	1.4	50MU334□A23216	
0.47	3.2	2.5	1.4	50MU474□B13225	
0.68	3.2	2.5	1.8	50MU684□B23225	
1.0	4.5	3.2	1.4	50MU105□C14532	
1.5	4.5	3.2	1.8	50MU155□C24532	
2.2	4.5	3.2	2.6	50MU225□C44532	
3.3	5.7	5.0	1.8	50MU335□D15750	
4.7	5.7	5.0	2.6	50MU475□D35750	

定格電圧 Rated Voltage (Vdc)	静電容量 Capacitance (μ F)	外形寸法 Size (mm)			品番 Part No.
		L	W	H	
63	0.00010	2.0	1.25	0.8	63MU101□Z12012
	0.00015	2.0	1.25	0.8	63MU151□Z12012
	0.00022	2.0	1.25	0.8	63MU221□Z12012
	0.00033	2.0	1.25	0.8	63MU331□Z12012
	0.00047	2.0	1.25	0.8	63MU471□Z12012
	0.00068	2.0	1.25	0.8	63MU681□Z12012
	0.0010	2.0	1.25	0.8	63MU102□Z12012
	0.0015	2.0	1.25	0.8	63MU152□Z12012
	0.0022	2.0	1.25	0.8	63MU222□Z12012
	0.0033	2.0	1.25	0.8	63MU332□Z12012
	0.0047	2.0	1.25	0.8	63MU472□Z12012
	0.0068	2.0	1.25	0.8	63MU682□Z12012
	0.010	2.0	1.25	0.8	63MU103□Z12012
	0.015	2.0	1.25	0.8	63MU153□Z12012
	0.022	2.0	1.25	0.8	63MU223□Z12012
	0.033	2.0	1.25	1.0	63MU333□Z22012
	0.047	3.2	1.6	1.0	63MU473□A13216
	0.068	3.2	1.6	1.0	63MU683□A13216
	0.10	3.2	1.6	1.0	63MU104□A13216
	100	0.0010	3.2	1.6	1.0
0.0015		3.2	1.6	1.0	100MU152□A13216
0.0022		3.2	1.6	1.0	100MU222□A13216
0.0033		3.2	1.6	1.0	100MU332□A13216
0.0047		3.2	1.6	1.0	100MU472□A13216
0.0068		3.2	1.6	1.0	100MU682□A13216
0.010		3.2	1.6	1.0	100MU103□A13216
0.015		3.2	1.6	1.0	100MU153□A13216
0.022		3.2	1.6	1.0	100MU223□A13216
0.033		3.2	1.6	1.0	100MU333□A13216
0.047		3.2	1.6	1.4	100MU473□A23216
0.068		3.2	2.5	1.4	100MU683□B13225
200	0.00010	3.2	1.6	1.0	200MU101MA13216
	0.0010	3.2	1.6	1.0	200MU102MA13216
	0.010	3.2	1.6	1.4	200MU103MA23216
	0.10	3.2	4.5	2.6	200MU104MC43245

◆寸法図／DIMENSIONS

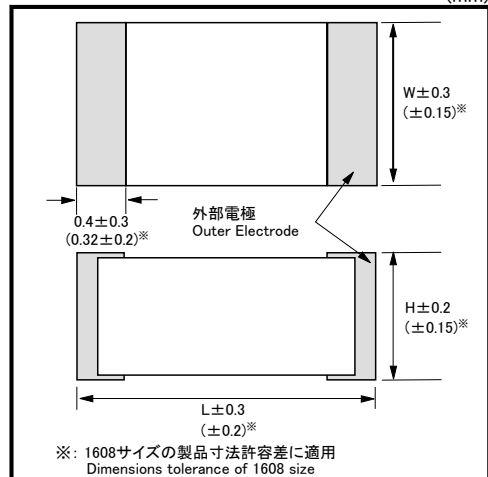

当社webサイトにてシミュレーション用のデータとしてPMLCAPのSPICEモデル(netlist)を提供しております。各種回路設計にお役立てください。
Our website offers the SPICE model (netlist) of PMLCAP as the data for simulations. Please make use of various circuit design.

MS series

85°C85%RH対応品
85°C85%RH Humidity Resistant

- ・85°C85%RH 1000時間保証。85°C85%RH 1000hours.
- ・鉛フリーフローはんだ付けが可能。Lead free reflow soldering is available.
- ・フローはんだ付けが可能。Flow soldering is available.

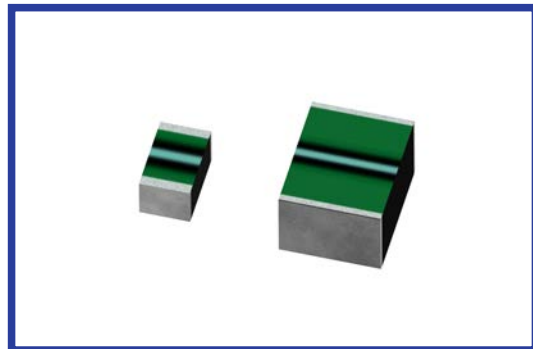

◆規格表/SPECIFICATIONS

項目 Item	特性 Characteristics
カテゴリ温度範囲 Category Temperature Range	-55~+125°C
定格電圧範囲 Rated Voltage Range	10~50Vdc
静電容量範囲 Capacitance Range	0.001~2.2 μF (102~225)
静電容量許容差 Capacitance Tolerance	±10% (K), ±20% (M)
損失角の正接 (tan δ) Dissipation Factor (MAX)	1.5%以下 (1kHz±20%, 5Vrms以下) 1.5% or less (1kHz±20%, 5Vrms or less)
耐電圧 Voltage Proof	定格電圧の150%を1分間または175%を1~5秒間印加後、異常の無いこと。 Nothing abnormal shall be found, when applying 150% of the rated voltage for 1 minute or 175% of the rated voltage for 1 second to 5 seconds.
絶縁抵抗 Insulation Resistance	C ≤ 0.1 μF: 3000MΩ 以上 (定格電圧印加1分後) C ≤ 0.1 μF: 3000MΩ or more (After 1 minute application of rated voltage) C > 0.1 μF: 300MΩ · μF 以上 (定格電圧印加1分後) C > 0.1 μF: 300MΩ · μF or more (After 1 minute application of rated voltage)

◆呼称方法/PART NUMBER

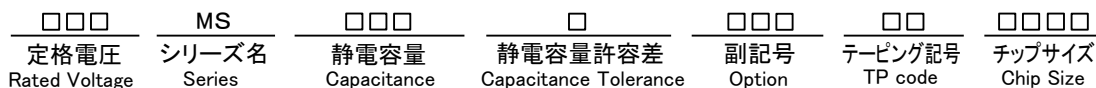

記号 Code	定格電圧 Rated Voltage
10	10Vdc
16	16Vdc
25	25Vdc
35	35Vdc
50	50Vdc

記号 Code	静電容量 Capacitance
153	0.015 μF
224	0.22 μF
105	1.0 μF

記号 Code	許容差 Tolerance
K	±10%
M	±20%

記号 Code	チップサイズ Chip Size
2012	2.0x1.25mm
3216	3.2x1.6mm
3225	3.2x2.5mm

◆標準品一覧表／STANDARD SIZE

□: 静電容量許容差記号 / Tolerance

定格電圧 Rated Voltage (Vdc)	静電容量 Capacitance (μ F)	外形寸法 Size (mm)			品番 Part No.
		L	W	H	
10	0.15	2.0	1.25	1.0	10MS154□Z22012
	1.0	3.2	1.6	1.4	10MS105□A23216
	1.5	3.2	2.5	1.4	10MS155□B13225
	2.2	3.2	2.5	1.8	10MS225□B23225
16	0.068	2.0	1.25	0.8	16MS683□Z12012
	0.10	2.0	1.25	1.0	16MS104□Z22012
	0.47	3.2	1.6	1.0	16MS474□A13216
	0.68	3.2	1.6	1.4	16MS684□A23216
25	1.0	3.2	2.5	1.4	16MS105□B13225
	0.047	2.0	1.25	1.0	25MS473□Z22012
	0.22	3.2	1.6	1.0	25MS224□A13216
	0.33	3.2	1.6	1.4	25MS334□A23216
35	0.47	3.2	2.5	1.4	25MS474□B13225
	0.68	3.2	2.5	1.8	25MS684□B23225
	0.0010	2.0	1.25	0.8	35MS102□Z12012
	0.0015	2.0	1.25	0.8	35MS152□Z12012
	0.0022	2.0	1.25	0.8	35MS222□Z12012
	0.0033	2.0	1.25	0.8	35MS332□Z12012
	0.0047	2.0	1.25	0.8	35MS472□Z12012
	0.0068	2.0	1.25	0.8	35MS682□Z12012
	0.010	2.0	1.25	0.8	35MS103□Z12012
	0.015	2.0	1.25	0.8	35MS153□Z12012
	0.022	2.0	1.25	0.8	35MS223□Z12012
	0.033	2.0	1.25	1.0	35MS333□Z22012
	0.047	3.2	1.6	1.0	35MS473□A13216
	0.068	3.2	1.6	1.0	35MS683□A13216
50	0.10	3.2	1.6	1.0	35MS104□A13216
	0.15	3.2	1.6	1.0	35MS154□A13216
	0.22	3.2	1.6	1.4	35MS224□A23216
	0.33	3.2	2.5	1.4	35MS334□B13225
	0.47	3.2	2.5	1.8	35MS474□B23225
	0.0010	3.2	1.6	1.0	50MS102□A13216
	0.0015	3.2	1.6	1.0	50MS152□A13216
	0.0022	3.2	1.6	1.0	50MS222□A13216
	0.0033	3.2	1.6	1.0	50MS332□A13216
	0.0047	3.2	1.6	1.0	50MS472□A13216
	0.0068	3.2	1.6	1.0	50MS682□A13216
	0.010	3.2	1.6	1.0	50MS103□A13216
	0.015	3.2	1.6	1.0	50MS153□A13216
	0.022	3.2	1.6	1.0	50MS223□A13216
0.033	3.2	1.6	1.0	50MS333□A13216	
0.047	3.2	1.6	1.4	50MS473□A23216	
0.068	3.2	2.5	1.4	50MS683□B13225	
0.10	3.2	2.5	1.8	50MS104□B23225	

◆寸法図／DIMENSIONS

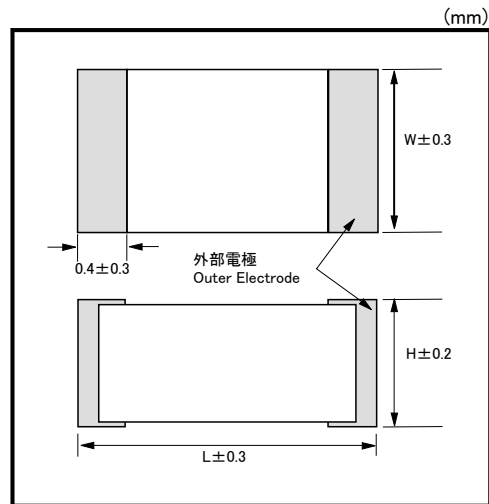

NS series

60°C90%RH対応品
60°C90%RH Humidity Resistant

- ・60°C90%RH 1000時間保証。60°C90%RH 1000hours.
- ・鉛フリーフローはんだ付けが可能。Lead free reflow soldering is available.
- ・フローはんだ付けが可能。Flow soldering is available.

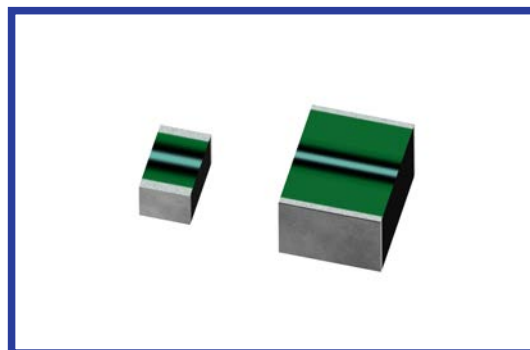

◆規格表/SPECIFICATIONS

項目 Item	特性 Characteristics
カテゴリ温度範囲 Category Temperature Range	-55~+125°C
定格電圧範囲 Rated Voltage Range	16~63Vdc
静電容量範囲 Capacitance Range	0.001~15 μF (102~156)
静電容量許容差 Capacitance Tolerance	±10% (K), ±20% (M)
損失角の正接 (tan δ) Dissipation Factor (MAX)	1.5%以下 (1kHz±20%, 5Vrms以下) 1.5% or less (1kHz±20%, 5Vrms or less)
耐電圧 Voltage Proof	定格電圧の150%を1分間または175%を1~5秒間印加後、異常の無いこと。 Nothing abnormal shall be found, when applying 150% of the rated voltage for 1 minute or 175% of the rated voltage for 1 second to 5 seconds.
絶縁抵抗 Insulation Resistance	C ≤ 0.1 μF: 3000MΩ 以上 (定格電圧印加1分後) C ≤ 0.1 μF: 3000MΩ or more (After 1 minute application of rated voltage) C > 0.1 μF: 300MΩ · μF 以上 (定格電圧印加1分後) C > 0.1 μF: 300MΩ · μF or more (After 1 minute application of rated voltage)

◆呼称方法/PART NUMBER

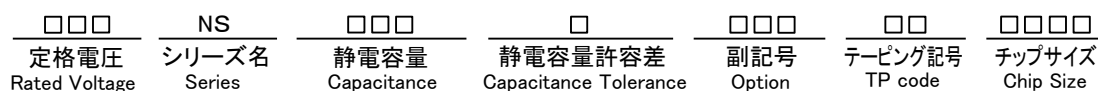

記号 Code	定格電圧 Rated Voltage
16	16Vdc
25	25Vdc
35	35Vdc
50	50Vdc
63	63Vdc

記号 Code	静電容量 Capacitance
153	0.015 μF
224	0.22 μF
105	1.0 μF
106	10 μF

記号 Code	許容差 Tolerance
K	±10%
M	±20%

記号 Code	チップサイズ Chip Size
2012	2.0x1.25mm
3216	3.2x1.6mm
3225	3.2x2.5mm
4532	4.5x3.2mm
5750	5.7x5.0mm

◆標準品一覧表／STANDARD SIZE

□: 静電容量許容差記号／Tolerance

定格電圧 Rated Voltage (Vdc)	静電容量 Capacitance (μ F)	外形寸法 Size (mm)			品番 Part No.
		L	W	H	
16	0.22	2.0	1.25	1.0	16NS224□Z22012
	1.5	3.2	1.6	1.4	16NS155□A23216
	4.7	4.5	3.2	1.4	16NS475□C14532
	6.8	4.5	3.2	1.8	16NS685□C24532
	10	5.7	5.0	1.8	16NS106□D15750
	15	5.7	5.0	1.8	16NS156□D15750
25	0.15	2.0	1.25	1.0	25NS154□Z22012
	1.0	3.2	1.6	1.4	25NS105□A23216
	1.5	3.2	2.5	1.4	25NS155□B13225
	2.2	3.2	2.5	1.8	25NS225□B23225
	3.3	4.5	3.2	1.4	25NS335□C14532
	4.7	4.5	3.2	1.8	25NS475□C24532
	6.8	5.7	5.0	1.8	25NS685□D15750
	10	5.7	5.0	1.8	25NS106□D15750
35	0.068	2.0	1.25	0.8	35NS683□Z12012
	0.1	2.0	1.25	1.0	35NS104□Z22012
	0.47	3.2	1.6	1.0	35NS474□A13216
	0.68	3.2	1.6	1.4	35NS684□A23216
	1.0	3.2	2.5	1.4	35NS105□B13225
	1.5	3.2	2.5	2.0	35NS155□B33225
	2.2	4.5	3.2	1.4	35NS225□C14532
	3.3	4.5	3.2	1.8	35NS335□C24532
	4.7	5.7	5.0	1.8	35NS475□D15750
	6.8	5.7	5.0	1.8	35NS685□D15750
50	0.047	2.0	1.2	1.0	50NS473□Z22012
	0.22	3.2	1.6	1.0	50NS224□A13216
	0.33	3.2	1.6	1.4	50NS334□A23216
	0.47	3.2	2.5	1.4	50NS474□B13225
	0.68	3.2	2.5	1.8	50NS684□B23225
	1.0	4.5	3.2	1.4	50NS105□C14532
	1.5	4.5	3.2	1.8	50NS155□C24532
	2.2	5.7	5.0	1.8	50NS225□D15750
	3.3	5.7	5.0	1.8	50NS335□D15750
63	0.001	2.0	1.25	0.8	63NS102□Z12012
	0.0015	2.0	1.25	0.8	63NS152□Z12012
	0.0022	2.0	1.25	0.8	63NS222□Z12012
	0.0033	2.0	1.25	0.8	63NS332□Z12012
	0.0047	2.0	1.25	0.8	63NS472□Z12012
	0.0068	2.0	1.25	0.8	63NS682□Z12012
	0.01	2.0	1.25	0.8	63NS103□Z12012
	0.015	2.0	1.25	0.8	63NS153□Z12012
	0.022	2.0	1.25	0.8	63NS223□Z12012
	0.033	2.0	1.25	1.0	63NS333□Z22012
	0.047	3.2	1.6	1.0	63NS473□A13216
	0.068	3.2	1.6	1.0	63NS683□A13216
	0.1	3.2	1.6	1.0	63NS104□A13216
	0.15	3.2	1.6	1.0	63NS154□A13216
	0.22	3.2	1.6	1.4	63NS224□A23216
	0.33	3.2	2.5	1.4	63NS334□B13225
	0.47	3.2	2.5	1.8	63NS474□B23225
	1.0	4.5	3.2	1.8	63NS105□C24532
	1.5	5.7	5.0	1.8	63NS155□D15750
	2.2	5.7	5.0	1.8	63NS225□D15750

◆寸法図／DIMENSIONS

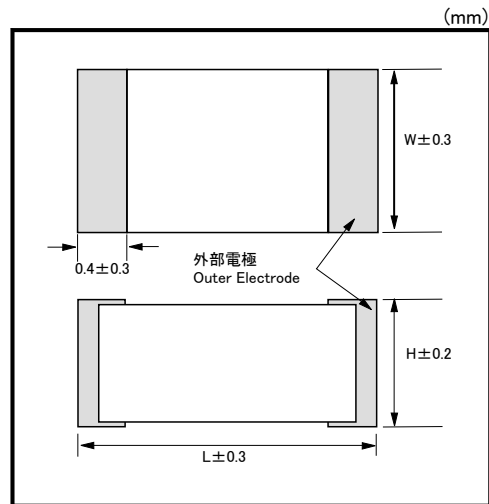

MH series

定格電圧 250Vdc,500Vdc対応品
Rated Voltage 250Vdc,500Vdc

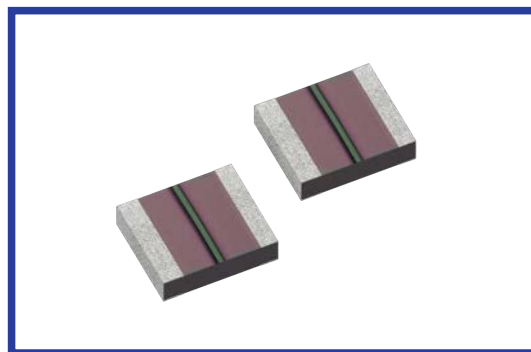

◆規格表/SPECIFICATIONS

項目 Item	特性 Characteristics
カテゴリ温度範囲 Category Temperature Range	-55~+125°C
定格電圧範囲 Rated Voltage Range	250, 500Vdc
静電容量許容差 Capacitance Tolerance	±10% (K), ±20% (M)
損失角の正接 (tan δ) Dissipation Factor (MAX)	1.5%以下 (1kHz±20%, 5Vrms以下) 1.5% or less (1kHz±20%, 5Vrms or less)
耐電圧 Voltage Proof	定格電圧の150%を1分間印加後、異常の無いこと。 Nothing abnormal shall be found, when applying 150% of the rated voltage for 1 minute
絶縁抵抗 Insulation Resistance	300MΩ・μF以上 (定格電圧印加1分後) 300MΩ・μF or more (After 1 minute application of rated voltage)

◆呼称方法/PART NUMBER

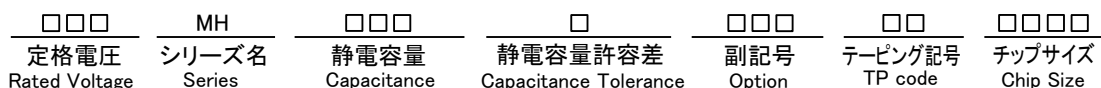

◆寸法図/DIMENSIONS

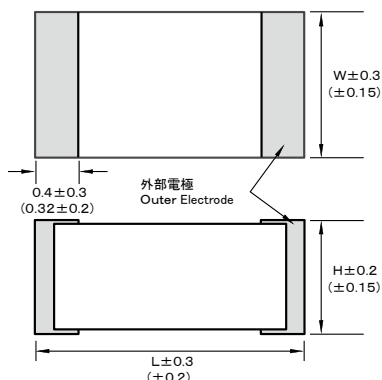

◆標準品一覧表/STANDARD SIZE

定格電圧 Rated Voltage (Vdc)	静電容量 Capacitance (μF)	外形寸法 Size (mm)			品番 Part No.
		L	W	H	
250	1.0	8.7	7.1	1.8	250MH105□F28271
500	0.22	8.7	7.1	1.8	500MH224□F28271

◆RoHS規制物質への対応／Conforming to RoHS Directive

品種 TYPE	フィルムコンデンサ Film Capacitors		薄膜高分子積層コンデンサ Polymer Multi-Layer Capacitors
	メタライズドタイプ Metallized	箔電極タイプ Foil	チップタイプ SMD
RoHS 指令 RoHS Compliance	対応済/Complied		
鉛 Lead	含有せず / Not contain		
端子材質 Terminal material	Fe/Cu/Sn or Cu/Sn	Fe/Cu/Sn	Brass/Cu/Sn or Brass/Cu paste/Sn
はんだ耐熱性 Resistance to Soldering heat	「はんだ付け作業」を参照ください。 Please find "Soldering Operation"		260°C リフロー/フロー 260°C Reflow/Flow
カドミウム Cadmium	含有せず / Not contain		
水銀 Mercury	含有せず / Not contain		
六価クロム Chrome(VI)	含有せず / Not contain		
PBB PBDE	含有せず / Not contain		
DEHP, BBP DBP, DIBP	含有せず / Not contain		
RoHS 対応品識別 Identification for RoHS Compliance Parts	内装・外装ラベルに RoHS Compliance を表記 Add "RoHS Compliance" marking on inner and outer carton lable		

※1:詳細は「リフロー許容条件」を参照ください。/Please find "Reflow Soldering Condition".

欧州REACH規則への適合について/Regarding compliance to European REACH Regulation

RIP3.8TGD(Technical Guidance Document: 2008/5/26 公開)の内容に基づき、弊社製電子部品は「意図的放出のない成形物」であり、欧州REACH規則第7条1項「登録」の適用外です。

According to the content of RIP3.8TGD(Technical Guidance Document) which is published on 26 May 2008, our electronic components are "articles without any intended release." Therefore the are not applicable for "Registration" for European REACH Regulation Article 7(1).

カタログ削除品、旧シリーズについてのお願い
PROPOSAL ON DELETION OF OLD SERIES FROM CATALOG

当社では、旧シリーズの生産終息を計画的に進めております。旧シリーズに対して代替シリーズをご用意しており、サイズメリット、コストメリットのある製品をご提案いたします。

Production discontinuation of old series at Rubycon is implemented as planned. Technical documents and samples are available upon the request to study alternative products.

製品の特徴 Features	旧シリーズ Previous Series	最終受注期日 Final Accepted Order Date	代替シリーズ Substitute Series
メタライズドポリプロピレン フィルムコンデンサ Metalized Polypropylene Filmcapacitors	MPW MPS	2008/09 2021/12	MPB
	MPW-HP	2008/09	MPH
	MPW-HVS MPR	2008/09 2009/09	MPE
メタライズドポリエステル フィルムコンデンサ Metalized Polyester Filmcapacitors	MMW-EF	2004/09	MPB , MMB
	MMW-HP MMH	2009/09 2021/12	MPH
	MMWA-EF	2008/09	MPKA , MMBA
PMLCAP	ST	2018/07	MU



ルビコン株式会社 本社、本社工場

〒399-4593 長野県伊那市西箕輪1938-1
TEL:0265-72-7111 FAX:0265-73-2914

営業本部

〒399-4593 長野県伊那市西箕輪1938-1
TEL:0265-72-7114 FAX:0265-76-5282

国内営業部・東京支店

〒171-0022 東京都豊島区南池袋2-30-8友泉南池袋ビル4F
TEL:03-5396-5001 FAX:03-5396-1190

名古屋支店

〒463-0072 愛知県名古屋市守山区金屋1-12-19
TEL:052-793-1210 FAX:052-791-1481

Rubycon Corporation Netherlands Branch

De Fruittuinen 18, 2132 NZ Hoofddorp, THE NETHERLANDS
TEL:31-23-554-3510 FAX:31-23-554-3515

Rubycon Corporation Munich Branch

Stefan-George-Ring 2, 81929 Muenchen GERMANY
TEL:49-89-930-86-250 FAX:49-89-930-86-459

Rubycon America Inc.

4293 Lee Avenue, Gurnee IL.60031, USA.
TEL:1-847-249-3450 FAX:1-847-578-1300

Rubycon Singapore Pte. Ltd.

2 Jurong East Street 21, IMM Building, #05-36, SINGAPORE 609601
TEL:65-6472-2466 FAX:65-6479-0241

Rubycon Singapore Pte. Ltd. Mumbai Liaison Office

A304, Dimple Arcade, Thakur Complex, Kandivali-East, Mumbai
400101, INDIA
TEL:91-22-2854-3154 FAX:91-22-2854-3155

Rubycon Singapore Pte. Ltd. Bengaluru Liaison Office

BHIVE FORUM, GNS TOWERS,
#18, Dairy circle road, Adegodi, Koramangala, Bengaluru - 560029,
INDIA

Rubycon Singapore Pte. Ltd. Delhi Liaison Office

(ABL Workspaces BC-3) F2 Sec 8 Noida, Noida, Uttar Pradesh
201301 INDIA

大阪支店

〒538-0053 大阪府大阪市鶴見区鶴見4-14-52
TEL:06-6913-0141 FAX:06-6913-0145

水戸営業所

〒312-0018 茨城県ひたちなか市笹野町2-12-2 マリンコートI 202号室
TEL:029-275-6531 FAX:029-275-6458

長野営業所

〒399-4593 長野県伊那市西箕輪1938-1
TEL:0265-73-6141 FAX:0265-76-5282

広島営業所

〒730-0017 広島県広島市中区鉄砲町1番20号 第3ウエノヤビル3階
TEL:082-222-3858 FAX:082-222-6585

海外営業部

〒171-0022 東京都豊島区南池袋2-30-8友泉南池袋ビル5F
TEL:03-5396-3738 FAX:03-5391-2466

Rubycon Hong Kong Limited

Unit 03 & 05, 30/F, Laws Commercial Plaza, 788 Cheung Sha Wan Road,
Kowloon, Hong Kong
TEL:852-2710-8875 FAX:852-2332-9237

Rubycon Corporation Taiwan Branch

Room 2, 13/F., No.318, Songjiang Road, Zhongshan District, Taipei City,
10468 Taiwan (R.O.C.)
TEL:886-2-2581-6068 FAX:886-2-2581-5068

Rubycon International (Shanghai) Co., Ltd.

Rm 1307, New Town Center, No.83, Lou Shan Guan Road Shanghai, CHINA
TEL:86-021-6236-9786 FAX:86-021-6236-8266

Rubycon International (Shanghai) Co., Ltd.

Chongqing Liaison Office
Room09, Floor18, Block A, Shinkansen Building, No.55, Chongqing Village,
Yuzhong District, Chongqing, CHINA

Rubycon Korea Co., Ltd.

Leaders Tower 301, #60-15 Kasan-Dong, Kumcheon-ku, Seoul, KOREA
TEL:82-02-855-8127 FAX:82-02-855-8128

Rubycon International (Thailand) Co., Ltd.

11th Floor, Sitthivorakit Bld., 5 Soi Pipat, Silom Road, Bangkok 10500,
THAILAND
TEL:66-02-266-8359 FAX:66-02-266-8360



本カタログの記載内容は、2023年03月現在のものであります。品名・仕様は予告なく変更、あるいは製造を中止する場合がございます。本カタログの記載内容は、製品の紹介資料です。ご使用にあたりましては別途仕様書を必ずご請求の上、ご確認ください。

The contents presented in this catalog have been update as of Mar.2023. Product name and specification are subject to change or cancellation of production without notice.

The contents presented in this catalog is an introductory document of the product. Please ask the detailed specification when using the products contained in this catalog.

極めて高信頼性を要求される回路、社会的に重大な影響を与えかつ直接生命・身体に対する危険を伴う用途（交通輸送機器・医療機器・航空機器・宇宙機器・原子力用機器等）に使用される場合には、事前にご相談ください。

Our products is not used in special circuit (transportation equipment , medical equipment , aerospace equipment , space equipment , nuclear equipment etc) where a defect in this component may cause the loss of human life or other significant damage in the case of high reliability application circuit/equipment , Please contact us in advance.



RUBYCON CORPORATION