

Für guten Kontakt bei starken Impulsen

For good contact at high pulse ratings

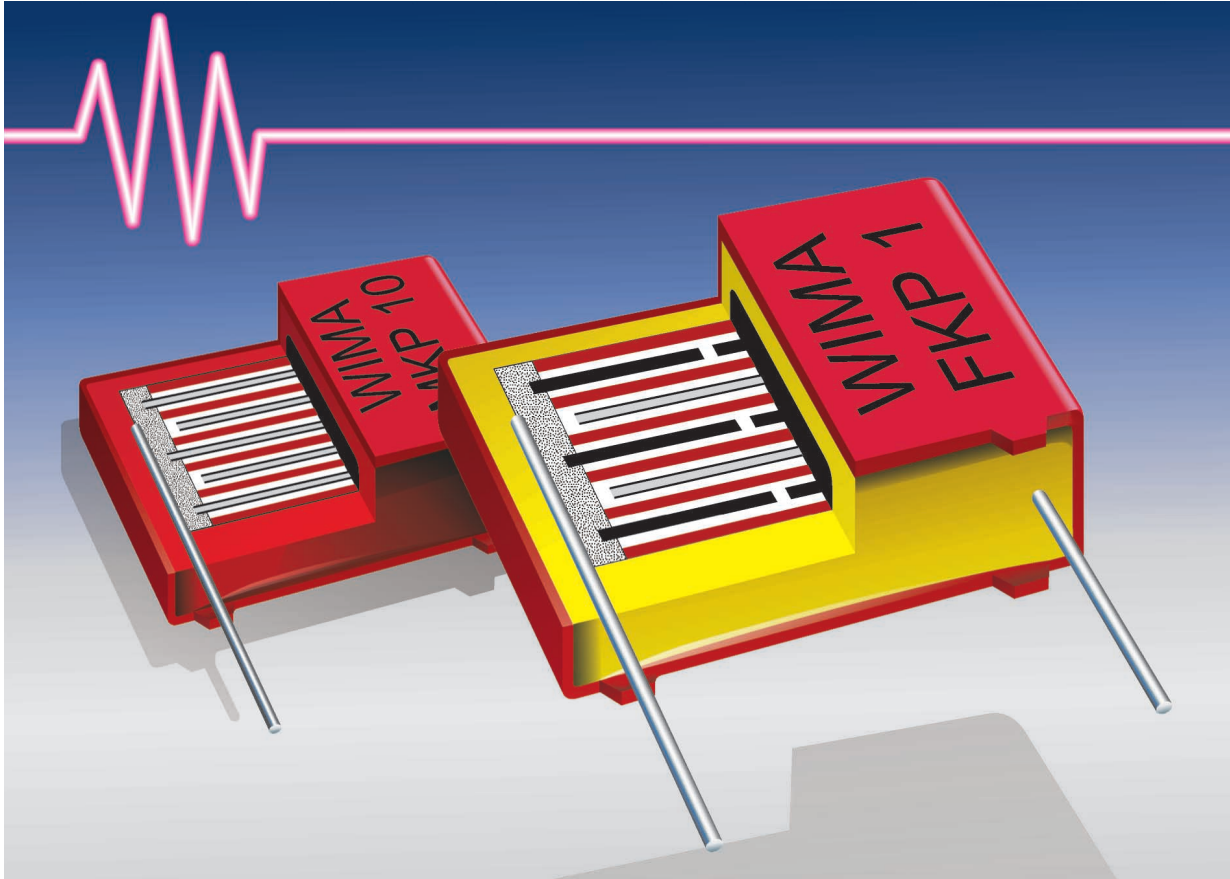

Bei der Herstellung betriebssicherer, ausheilfähiger Impulskondensatoren ist die Strombelastbarkeit der Kontaktierung, d. i. der Übergang zwischen Anschluß und Belag, ein wichtiges Konstruktionskriterium.

■ Das Aufbauprinzip der Reihe **WIMA MKP 10** besteht aus einer nicht metallisierten Dielektrikumsfolie und einer doppelseitig metallisierten Belagfolie als Elektrode. Durch Kurzschluß der Metallisierung über die Schoopschicht ist die Belagfolie dielektrisch nicht wirksam. Durch die beidseitige Metallisierung wird die elektrische Leitfähigkeit verbessert und die Kontaktierungsfläche verdoppelt. Die bessere Verbindung zwischen Elektrodenbelag und Schoopschicht erlaubt eine hohe Strom- bzw. Impulsbelastbarkeit. Die Eigenschaften metallisierter Kondensatoren, wie z. B. hervorragende Ausheilfähigkeit und hohe Volumenkapazität, bleiben erhalten.

■ Für extreme Impulsbelastungen bis zu $18\,000\text{ V}/\mu\text{s}$ wurde die Baureihe **WIMA FKP 1** entwickelt. Sie ist mit einer internen Reihenschaltung realisiert, wobei Beläge aus Metallfolie mit einer beidseitig metallisierten Blindlage kombiniert sind. Die Metallfolienbeläge sind an der Stirnseite flächenhaft kontaktiert. Gleichzeitig ist der Kondensator durch die zweifach metallisierte Blindlage voll ausheilfähig. Der WIMA FKP 1 stellt in puncto Impulsbelastbarkeit das High-End der Kondensatorentechnologie dar.

An important construction criterion in the manufacture of reliable, self-healing capacitors for pulse applications is the current-carrying capacity of the contacts, i. e. the connection between the terminating wires and the electrodes.

■ The construction principle of the series **WIMA MKP 10** consists of a non-metallized dielectric film and an electrode carrier film metallized on both sides acting as electrode. By short-circuiting the metallization over the schoopage, the carrier film is in fieldfree space and is not dielectrically active. Thanks to the metallization on both sides, the electrical conductivity is considerably improved and the contact surface between the electrodes and the schoopage layer is doubled. This results in better contact and allows for high current and pulse loading capacities. The properties of metallized capacitors such as excellent self-healing and high volume capacitance remain unchanged.

■ The **WIMA FKP 1** series was developed for extremely high pulse loads of up to $18\,000\text{ V}/\mu\text{sec}$. It has an internal series connection, the metal foil electrodes being combined with a floating electrode metallized on both sides. The metal foil electrodes are safely contacted on both sides of the end surfaces. At the same time the capacitor is fully self-healing due to the floating electrode metallized on both sides. As regards pulse loading capacity, WIMA FKP 1 represents the high-end of capacitor technology.

WIMA MKP 10

Impulsfeste Polypropylen-Kondensatoren

■ Für Anwendungen in Schaltnetzteilen, in der Beleuchtungs-, Fernseh- und Monitortechnik sowie für Lautsprecherweichen. ■ Impulsfester und ausheilfähiger Aufbau mit doppelseitig metallisierter Belagfolie (siehe Seite 72).

Technische Angaben

Dielektrikum: Polypropylen-Folie.

Beläge: Doppelseitig metallisierte Kunststoff-Folie.

Umhüllung: Flammhemmendes Kunststoffgehäuse, UL 94 V-0.

Farbe: Rot. Aufdruck: Schwarz. Epoxidharzverguß: Rot.

Temperaturbereich: -55° C bis +100° C.

Prüfklasse: 55/100/56 nach IEC.

Isolationswerte bei +20° C:

$C \leq 0,33 \mu\text{F}$: $\geq 1 \cdot 10^5 \text{ M}\Omega$ (Mittelwert: $5 \cdot 10^5 \text{ M}\Omega$)

$C > 0,33 \mu\text{F}$: $\geq 30\,000 \text{ s (M}\Omega \cdot \mu\text{F)}$ (Mittelwert: 100\,000 s)

Meßspannung: 100 V/1 min.

Verlustfaktoren bei +20° C: $\tan \delta$

Gemessen bei	$C \leq 0,1 \mu\text{F}$	$0,1 \mu\text{F} < C \leq 1,0 \mu\text{F}$	$C > 1,0 \mu\text{F}$
1 kHz	$\leq 3 \cdot 10^{-4}$	$\leq 3 \cdot 10^{-4}$	$\leq 3 \cdot 10^{-4}$
10 kHz	$\leq 4 \cdot 10^{-4}$	$\leq 6 \cdot 10^{-4}$	-
100 kHz	$\leq 15 \cdot 10^{-4}$	-	-

Kapazitätstoleranzen: $\pm 20\%$, $\pm 10\%$, $\pm 5\%$.

Impulsbelastung:

C-Wert pF/ μF	Flankensteilheit V/ μs max. Betrieb					
	100 V-	250 V-	400 V-	630 V-	1000 V-	1600 V- 2000 V-
1000 ... 2200	1000	1000	1000	1000	1800	3000
3300 ... 6800	600	600	600	950	1300	1500
0,01 ... 0,022	400	400	420	950	950	1000
0,033 ... 0,068	200	150	200	600	700	700
0,1 ... 0,22	110	130	130	350	430	430
0,33 ... 0,68	70	85	100	250	300	300
1,0 ... 2,2	55	65	75	150	200	250
3,3 ... 4,7	40	65	75	150	-	-
6,8 ... 10	35	35	-	-	-	-

Prüfspannung: $1,6 U_N$ 2 s.

Schwingen: 6 h bei 10...2000 Hz und 0,75 mm Auslenkung bzw. 10 g nach IEC 60068-2-6.

Unterdruck: 1 kPa = 10 mbar nach IEC 60068-2-13.

Stoßtest: 4000 Stöße mit 390 m/s² nach IEC 60068-2-29.

Spannungsderating: Die zulässige Spannung vermindert sich gegenüber der Nennspannung bei Gleichspannungsbetrieb ab +85° C, bei Wechselspannungsbetrieb ab +75° C um 1,35% je 1 K.

Kurven siehe Seite 7.

Polypropylene capacitors for pulse applications

■ For applications in switch mode power supplies, frequency dividing in loudspeakers, in lighting, monitors and TV-sets. ■ Self-healing pulse duty construction with electrodes of double-sided metallized carrier film (see page 72).

Technical Data

Dielectric: Polypropylene film.

Capacitor electrodes: Double-sided metallized plastic film.

Encapsulation: Flame-retardent plastic case, UL 94 V-0.

Colour: Red. Marking: Black. Epoxy resin seal: Red.

Temperature range: -55° C to +100° C.

Test category: 55/100/56 in accordance with IEC.

Insulation resistance at +20° C:

$C \leq 0,33 \mu\text{F}$: $\geq 1 \times 10^5 \text{ M}\Omega$ (mean value: $5 \times 10^5 \text{ M}\Omega$)

$C > 0,33 \mu\text{F}$: $\geq 30\,000 \text{ sec (M}\Omega \times \mu\text{F)}$ (mean value: 100\,000 sec)

Measuring voltage: 100 V/1 min.

Dissipations factors at +20° C: $\tan \delta$

at f	$C \leq 0,1 \mu\text{F}$	$0,1 \mu\text{F} < C \leq 1,0 \mu\text{F}$	$C > 1,0 \mu\text{F}$
1 kHz	$\leq 3 \times 10^{-4}$	$\leq 3 \times 10^{-4}$	$\leq 3 \times 10^{-4}$
10 kHz	$\leq 4 \times 10^{-4}$	$\leq 6 \times 10^{-4}$	-
100 kHz	$\leq 15 \times 10^{-4}$	-	-

Capacitance tolerances: $\pm 20\%$, $\pm 10\%$, $\pm 5\%$.

Maximum pulse rise time:

Capacitance pF/ μF	Pulse rise time V/ μsec max. operation					
	100 VDC	250 VDC	400 VDC	630 VDC	1000 VDC	1600 VDC 2000 VDC
1000 ... 2200	1000	1000	1000	1000	1800	3000
3300 ... 6800	600	600	600	950	1300	1500
0,01 ... 0,022	400	400	420	950	950	1000
0,033 ... 0,068	200	150	200	600	700	700
0,1 ... 0,22	110	130	130	350	430	430
0,33 ... 0,68	70	85	100	250	300	300
1,0 ... 2,2	55	65	75	150	200	250
3,3 ... 4,7	40	65	75	150	-	-
6,8 ... 10	35	35	-	-	-	-

Test voltage: $1,6 U_r$, 2 sec.

Vibration: 6 hours at 10...2000 Hz and 0.75 mm displacement amplitude or 10 g in accordance with IEC 60068-2-6.

Low air density: 1 kPa = 10 mbar in accordance with IEC 60068-2-13.

Bump test: 4000 bumps at 390 m/sec² in accordance with IEC 60068-2-29.

Voltage derating: A voltage derating factor of 1.35% per K must be applied from +85° C for DC voltages and from +75° C for AC voltages.

Graphs see page 7.

Werteübersicht / General Data

Kapazität Capacitance	100 VDC/63 VAC*				250 VDC/180 VAC*				400 VDC/250 VAC*				630 VDC/400 VAC*			
	W	H	L	PCM**	W	H	L	PCM**	W	H	L	PCM**	W	H	L	PCM**
1000 pF	4	9	10	7.5	4	9	10	7.5	4	9	10	7.5	4	9	10	7.5**
1500 „	4	9	10	7.5	4	9	10	7.5	4	9	10	7.5	4	9	10	7.5**
2200 „	4	9	10	7.5	4	9	10	7.5	4	9	10	7.5	4	9	10	7.5**
3300 „	4	9	10	7.5	4	9	10	7.5	4	9	10	7.5	4	9	10	7.5**
4700 „	4	9	10	7.5	4	9	10	7.5	4	9	10	7.5	4	9	10	7.5**
6800 „	4	9	10	7.5	4	9	10	7.5	4	9	10	7.5	4	9	13	10
0.01 µF	4	9	10	7.5	4	9	10	7.5	4	9	10	7.5	4	9	13	10
0.015 „	4	9	10	7.5	4	9	10	7.5	4	9	13	10	5	11	13	10
0.022 „	4	9	10	7.5	4	9	10	7.5	4	9.5	13	10	6	12.5	13	10
0.033 „	4	9	13	10*	4	9.5	13	10	5	11	13	10	5	11	18	15
0.047 „	4	9.5	13	10*	5	11	13	10	5	11	18	15	6	12.5	18	15
0.068 „	5	11	13	10*	6	12.5	13	10	6	12.5	18	15	7	14	18	15
0.1 µF	6	12.5	13	10*	5	11	18	15	7	14	18	15	7	16.5	26.5	22.5
0.15 „	6	12.5	18	15*	6	12.5	18	15	8	15	18	15	8.5	18.5	26.5	22.5
0.22 „	7	14	18	15*	7	14	18	15	7	16.5	26.5	22.5	10.5	19	26.5	22.5
0.33 „	8	15	18	15*	8	15	18	15	8.5	18.5	26.5	22.5	11	21	26.5	22.5
0.47 „	7	16.5	26.5	22.5*	7	16.5	26.5	22.5	10.5	19	26.5	22.5	11	21	31.5	27.5
0.68 „	8.5	18.5	26.5	22.5*	8.5	18.5	26.5	22.5	11	21	31.5	27.5	15	26	31.5	27.5
1.0 µF	10.5	19	26.5	22.5*	11	21	26.5	22.5	13	24	31.5	27.5	17	29	31.5	27.5
1.5 „	11	21	31.5	27.5*	13	24	31.5	27.5	17	29	31.5	27.5	19	32	41.5	37.5
2.2 „	13	24	31.5	27.5*	15	26	31.5	27.5	17	29	41.5	37.5	20	39.5	41.5	37.5
3.3 „	17	29	31.5	27.5*	17	34.5	31.5	27.5	20	39.5	41.5	37.5	24	45.5	41.5	37.5
4.7 „	17	29	41.5	37.5*	19	32	41.5	37.5	24	45.5	41.5	37.5				
6.8 „	20	39.5	41.5	37.5*	20	39.5	41.5	37.5								
10 µF	24	45.5	41.5	37.5*	24	45.5	41.5	37.5								

* Wechselspannungen: $f \leq 1000 \text{ Hz}$; $1,4 \cdot U_{\text{eff}} \sim + U_- \leq U_N$

* AC voltage: $f \leq 1000 \text{ Hz}$; $1,4 \times U_{\text{rms}} + U_{\text{DC}} \leq U_r$

Neue Werte. / New values.

* Auch in 160 V- erhältlich. / Also available in 160 VDC.

** Zulässige Nennwechselspannung max. 280 V~

** Admissible AC voltage 280 VAC max.

** PCM = Printed circuit module = Rastermaß

** PCM = Printed circuit module = lead spacing

Alle Maße in mm.

Dims. in mm.

Die Ionisationseinsatzgrenze kann im Einzelfall

unter der Wechselspannungsangabe liegen.

Ionisation inception level in isolated cases may be

lower than admissible rated AC voltage

Die Kondensatoren der Reihe mit 400 V~ sind in Serienschaltung ausgeführt.

The capacitors of the 400 VAC range are series-connected.

Gegurtete Ausführung siehe Seite 93.

Taped version see page 93.

Abweichungen und Konstruktionsänderungen vorbehalten.

Rights reserved to amend design data without prior notification.

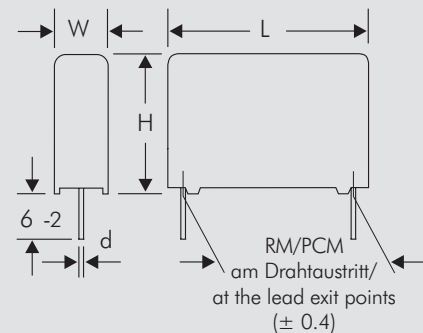

ø d	PCM	W
0.7	7.5	
0.7	10	
0.8	15-22.5	
0.8	27.5	≤ 15
1.0	27.5	> 15
1.0	37.5	

Fortsetzung Seite 68. / Continuation page 68.

WIMA MKP 10

Werteübersicht / General Data

Kapazität Capacitance	1000 VDC/600 VAC*				1600 VDC/650 VAC*				2000 VDC/700 VAC*			
	W	H	L	PCM**	W	H	L	PCM**	W	H	L	PCM**
1000 pF	4	9	13	10	4	9	13	10	4	9	13	10
1500 "	4	9	13	10	4	9	13	10	4	9.5	13	10
2200 "	4	9	13	10	4	9	13	10	5	11	13	10
3300 "	4	9	13	10	4	9.5	13	10	5	11	18	15
4700 "	4	9.5	13	10	5	11	13	10	5	11	18	15
6800 "	5	11	13	10	6	12.5	13	10	6	12.5	18	15
0.01 µF	5	11	13	10	5	11	18	15	7	14	18	15
0.015 "	5	11	18	15	6	12.5	18	15	8	15	18	15
0.022 "	6	12.5	18	15	7	14	18	15	7	16.5	26.5	22.5
0.033 "	7	14	18	15	7	16.5	26.5	22.5	8.5	18.5	26.5	22.5
0.047 "	8	15	18	15	8.5	18.5	26.5	22.5	10.5	19	26.5	22.5
0.068 "	7	16.5	26.5	22.5	10.5	19	26.5	22.5	11	21	26.5	22.5
0.1 µF	8.5	18.5	26.5	22.5	11	21	26.5	22.5	13	24	31.5	27.5
0.15 "	11	21	26.5	22.5	13	24	31.5	27.5	15	26	31.5	27.5
0.22 "	11	21	31.5	27.5	15	26	31.5	27.5	17	34.5	31.5	27.5
0.33 "	15	26	31.5	27.5	17	34.5	31.5	27.5	19	32	41.5	37.5
0.47 "	17	29	31.5	27.5	19	32	41.5	37.5	20	39.5	41.5	37.5
0.68 "	17	29	41.5	37.5	20	39.5	41.5	37.5	24	45.5	41.5	37.5
1.0 µF	20	39.5	41.5	37.5	24	45.5	41.5	37.5				
1.5 "	24	45.5	41.5	37.5								

* Wechselspannungen: $f \leq 1000 \text{ Hz}$; $1,4 \cdot U_{\text{eff}} \sim + U_- \leq U_N$

* AC voltage: $f \leq 1000 \text{ Hz}$; $1,4 \times U_{\text{rms}} + U_{\text{DC}} \leq U_r$

** PCM = Printed circuit module = Rastermaß

** PCM = Printed circuit module = lead spacing

Alle Maße in mm. / Dims. in mm.

Die Ionisationseinsatzgrenze kann im Einzelfall unter der Wechselspannungsangabe liegen.

Ionisation inception level in isolated cases may be lower than admissible rated AC voltage

Die Kondensatoren der Reihe mit 600 V~, 650 V~ und 700 V~ sind in Serienschaltung ausgeführt.

The capacitors of the 600 VAC, 650 VAC and 700 VAC ranges are series-connected.

Gegurtete Ausführung siehe Seite 93.

Taped version see page 93.

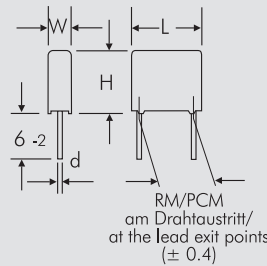

ø d	PCM	W
0.7	7.5	
0.7	10	
0.8	15-22.5	
0.8	27.5	≤ 15
1.0	27.5	> 15
1.0	37.5	

Abweichungen und Konstruktionsänderungen vorbehalten.
Rights reserved to amend design data without prior notification.

Zulässige Wechselspannung in Abhängigkeit von der Frequenz bei 10° C Eigenerwärmung (Richtwerte):
Permissible AC voltage in relation to frequency at 10° C internal temperature rise (general guide):

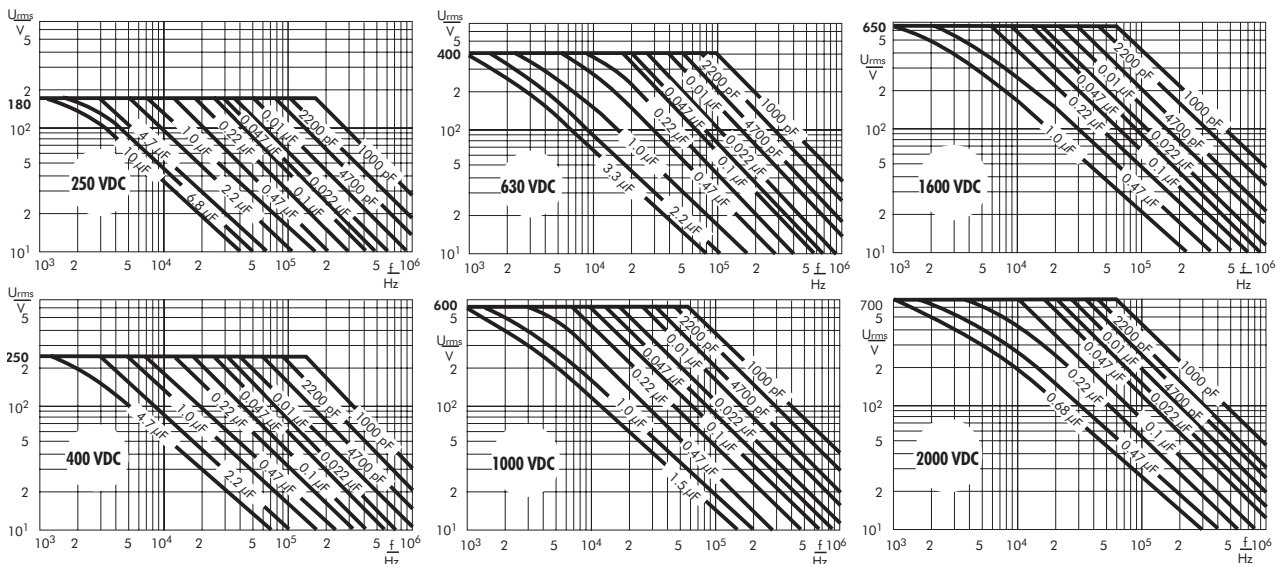

WIMA FKP 1

Impulsfeste Polypropylen-Kondensatoren

■ Mit Metallfolienbelägen und innerer Reihenschaltung für höchste Strombelastbarkeit. ■ Einsatzgebiete: Dämpfungs- und Kommutierungs-Kondensator in Schaltzerteilen, Umrichterschaltungen der Antriebs- und Energietechnik sowie Ablenschaltungen der Fernseh- und Monitortechnik.

Technische Angaben

Dielektrikum: Polypropylen-Folie.

Beläge: Aluminiumfolie und doppelseitig metallisierte Kunststoff-Folie.

Umhüllung: Flammhemmendes Kunststoffgehäuse, UL 94 V-0. Farbe: Rot. Aufdruck: Schwarz. Epoxidharzverguß: Gelb.

Temperaturbereich: -55° C bis +100° C.

Prüfklasse: 55/100/56 nach IEC.

Isolationswerte bei +20° C:

$C \leq 0,1 \mu\text{F}$: $\geq 1 \cdot 10^5 \text{ M}\Omega$ (Mittelwert: $5 \cdot 10^5 \text{ M}\Omega$)

$C > 0,1 \mu\text{F}$: $\geq 30000 \text{ s (M}\Omega \cdot \mu\text{F)}$ (Mittelwert: 100000 s)

Meßspannung: 100 V/1 min.

Verlustfaktoren bei +20° C: $\tan \delta$

Gemessen bei	$C \leq 0,1 \mu\text{F}$	$0,1 \mu\text{F} < C \leq 0,22 \mu\text{F}$
1 kHz	$\leq 3 \cdot 10^{-4}$	$\leq 3 \cdot 10^{-4}$
10 kHz	$\leq 4 \cdot 10^{-4}$	$\leq 6 \cdot 10^{-4}$
100 kHz	$\leq 10 \cdot 10^{-4}$	-

Kapazitätstoleranzen: $\pm 20\%$, $\pm 10\%$, $\pm 5\%$, andere Toleranzen auf Anfrage.

Impulsbelastung:

C-Wert pF/ μF	Flankensteilheit V/ μs max. Betrieb							
	400 V-	630 V-	1000 V-	1250 V-	1600 V-	2000 V-	4000 V-	6000 V-
100 ... 220	-	-	-	-	18000	18000	-	-
330 ... 680	-	-	-	-	15000	16000	16000	16000
1000 ... 2200	13200	13200	13200	13200	14000	15000	15000	15000
3300 ... 6800	5500	5500	10000	11200	12000	13000	13000	13000
0,01 ... 0,022	2700	3300	5500	7700	8000	8500	8500	8500
0,033 ... 0,068	1900	2200	4200	4900	5000	5000	-	-
0,1 ... 0,22	1200	1500	2200	3100	3500	-	-	-

Prüfspannung: 2 U_{Nv} , 2 s / 6 kV; 1,6 U_{Nv} , 2 s.

Schwingen: 6 h bei 10...2000 Hz und 0,75 mm Auslenkung bzw. 10 g nach IEC 60068-2-6.

Unterdruck: 1 kPa = 10 mbar nach IEC 60068-2-13.

Stoßtest: 4000 Stöße mit 390 m/s² nach IEC 60068-2-29.

Spannungsderating: Die zulässige Spannung vermindert sich gegenüber der Nennspannung bei Gleichspannungsbetrieb ab +85° C, bei Wechselspannungsbetrieb ab +75° C um 1,35% je 1 K.

Kurven siehe Seite 12.

Polypropylene capacitors for pulse applications

■ With metal foil electrode, internally series-connected for very high current ratings. ■ Applications: Damping and commutation capacitors in switch mode power supplies, static frequency changes in drive and power electronics, deflection systems in monitors and TV-sets.

Technical Data

Dielectric: Polypropylene film.

Capacitor electrodes: Aluminium foil and double-sided metallized plastic film.

Encapsulation: Flame-retardent plastic case, UL 94 V-0. Colour: Red. Marking: Black. Epoxy resin seal: Yellow.

Temperature range: -55° C to +100° C.

Test category: 55/100/56 in accordance with IEC.

Insulation resistance at +20° C:

$C \leq 0.1 \mu\text{F}$: $\geq 1 \times 10^5 \text{ M}\Omega$ (mean value: $5 \times 10^5 \text{ M}\Omega$)

$C > 0.1 \mu\text{F}$: $\geq 30000 \text{ sec (M}\Omega \times \mu\text{F)}$ (mean value: 100000 sec)

Measuring voltage: 100 V/1 min.

Dissipations factors at +20° C: $\tan \delta$

at f	$C \leq 0.1 \mu\text{F}$	$0.1 \mu\text{F} < C \leq 0.22 \mu\text{F}$
1 kHz	$\leq 3 \times 10^{-4}$	$\leq 3 \times 10^{-4}$
10 kHz	$\leq 4 \times 10^{-4}$	$\leq 6 \times 10^{-4}$
100 kHz	$\leq 10 \times 10^{-4}$	-

Capacitance tolerances: $\pm 20\%$, $\pm 10\%$, $\pm 5\%$ (closer tolerances are available subject to special enquiry).

Maximum pulse rise time:

Capacitance pF/ μF	Pulse rise time V/ μsec max. operation							
	400 VDC	630 VDC	1000 VDC	1250 VDC	1600 VDC	2000 VDC	4000 VDC	6000 VDC
100 ... 220	-	-	-	-	18000	18000	-	-
330 ... 680	-	-	-	-	15000	16000	16000	16000
1000 ... 2200	13200	13200	13200	13200	14000	15000	15000	15000
3300 ... 6800	5500	5500	10000	11200	12000	13000	13000	13000
0,01 ... 0,022	2700	3300	5500	7700	8000	8500	8500	8500
0,033 ... 0,068	1900	2200	4200	4900	5000	5000	-	-
0,1 ... 0,22	1200	1500	2200	3100	3500	-	-	-

Test voltage: 2 Ur, 2 sec / 6000 VDC; 1,6 Ur, 2 sec.

Vibration: 6 hours at 10...2000 Hz and 0.75 mm displacement amplitude or 10 g in accordance with IEC 60068-2-6.

Low air density: 1 kPa = 10 mbar in accordance with IEC 60068-2-13.

Bump test: 4000 bumps at 390 m/sec² in accordance with IEC 60068-2-29.

Voltage derating: A voltage derating factor of 1.35% per K must be applied from +85° C for DC voltages and from +75° C for AC voltages.

Graphs see page 12.

Werteübersicht / General Data

Kapazität Capacitance	400 VDC/250 VAC*				630 VDC/400 VAC*				1000 VDC/600 VAC*				1250 VDC/600 VAC*			
	W	H	L	PCM**	W	H	L	PCM**	W	H	L	PCM**	W	H	L	PCM**
1000 pF	5	11	18	15	5	11	18	15	5	11	18	15	5	11	18	15
1500 "	5	11	18	15	5	11	18	15	5	11	18	15	5	11	18	15
2200 "	5	11	18	15	5	11	18	15	5	11	18	15	5	11	18	15
3300 "	5	11	18	15	5	11	18	15	5	11	18	15	6	12.5	18	15
4700 "	5	11	18	15	5	11	18	15	6	12.5	18	15	7	14	18	15
6800 "	5	11	18	15	6	12.5	18	15	7	14	18	15	8	15	18	15*
													5	14	26.5	22.5*
0.01 µF	5	11	18	15	7	14	18	15*	8	15	18	15*	7	16.5	26.5	22.5
					5	14	26.5	22.5*	6	15	26.5	22.5*				
0.015 "	6	12.5	18	15	8	15	18	15*	6	15	26.5	22.5	8.5	18.5	26.5	22.5
					6	15	26.5	22.5*								
0.022 "	7	14	18	15*	7	16.5	26.5	22.5	8.5	18.5	26.5	22.5	10.5	20.5	26.5	22.5
	5	14	26.5	22.5*												
0.033 "	8	15	18	15*	8.5	18.5	26.5	22.5	10.5	20.5	26.5	22.5*	11	21	31.5	27.5*
	6	15	26.5	22.5*					9	19	31.5	27.5*	9	19	41.5	37.5*
0.047 "	7	16.5	26.5	22.5	10.5	20.5	26.5	22.5*	11	21	31.5	27.5	13	24	31.5	27.5*
					9	19	31.5	27.5*					11	22	41.5	37.5*
0.068 "	8.5	18.5	26.5	22.5	11	21	31.5	27.5*	13	24	31.5	27.5*	11	22	41.5	37.5
					9	19	41.5	37.5*	11	22	41.5	37.5*				
0.1 µF	10.5	20.5	26.5	22.5*	13	24	31.5	27.5*	13	24	41.5	37.5	15	26	41.5	37.5
	9	19	31.5	27.5*	11	22	41.5	37.5*								
0.15 "	11	21	31.5	27.5	13	24	41.5	37.5	15	26	41.5	37.5	17	29	41.5	37.5
0.22 "	13	24	31.5	27.5	15	26	41.5	37.5	19	32	41.5	37.5	19	32	41.5	37.5

* Wechselspannungen: $f \leq 1000 \text{ Hz}$; $1,4 \cdot U_{\text{eff}} \sim + U_- \leq U_N$

* AC voltage: $f \leq 1000 \text{ Hz}$; $1,4 \times U_{\text{rms}} + U_{\text{DC}} \leq U_r$

Neue Werte. / New values.

** PCM = Printed circuit module = Rastermaß

** PCM = Printed circuit module = lead spacing

Die Ionisationseinsatzgrenze kann im Einzelfall unter der Wechselspannungsangabe liegen.
Ionisation inception level in isolated cases may be lower than admissible rated AC voltage

Zwischenwerte auf Anfrage
Other values available subject to special enquiry.

* Bei Bestellung bitte das gewünschte Rastermaß angeben.
Wenn keine Angaben erfolgen, wird grundsätzlich das kleinere RM geliefert.

* On ordering please state the required PCM (lead spacing).
If not specified, smaller PCM will be booked.

Alle Maße in mm. / Dims. in mm.

Gegurtete Ausführung siehe Seite 93.
Taped version see page 93.

Abweichungen und Konstruktionsänderungen vorbehalten.
Rights reserved to amend design data without prior notification.

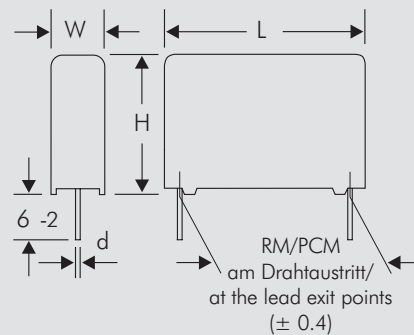

$d = 0.8 \varnothing$ if PCM 15 ... 27.5
 $d = 1.0 \varnothing$ if PCM 37.5

Fortsetzung Seite 71. / Continuation page 71.

Werteübersicht / General Data

Kapazität Capacitance	1600 VDC/650 VAC*				2000 VDC/700 VAC*				4000 VDC/700 VAC*				6000 VDC/700 VAC*			
	W	H	L	PCM**	W	H	L	PCM**	W	H	L	PCM**	W	H	L	PCM**
100 pF	5	11	18	15	5	11	18	15								
150 "	5	11	18	15	5	11	18	15								
220 "	5	11	18	15	5	11	18	15								
330 "	5	11	18	15	6	12.5	18	15								
470 "	5	11	18	15	6	12.5	18	15	5	14	26.5	22.5	5	14	26.5	22.5
680 "	5	11	18	15	6	12.5	18	15	5	14	26.5	22.5	5	14	26.5	22.5
1000 pF	6	12.5	18	15*	7	14	18	15*	5	14	26.5	22.5	5	14	26.5	22.5
1500 "	5	14	26.5	22.5*	5	14	26.5	22.5*	5	14	26.5	22.5	5	14	26.5	22.5
2200 "	7	14	18	15*	6	15	26.5	22.5	7	16.5	26.5	22.5	7	16.5	26.5	22.5
	5	14	26.5	22.5*												
	8	15	18	15*	7	16.5	26.5	22.5	8.5	18.5	26.5	22.5	10.5	20.5	26.5	22.5
	5	14	26.5	22.5*												
3300 "	6	15	26.5	22.5	7	16.5	26.5	22.5	10.5	20.5	26.5	22.5	10.5	20.5	26.5	22.5
4700 "	7	16.5	26.5	22.5	8.5	18.5	26.5	22.5	11	21	31.5	27.5	11	21	31.5	27.5
6800 "	8.5	18.5	26.5	22.5	10.5	20.5	26.5	22.5	13	24	31.5	27.5	13	24	31.5	27.5
0.01 µF	10.5	20.5	26.5	22.5	11	21	31.5	27.5	15	26	31.5	27.5	15	26	31.5	27.5
0.015 "	11	21	31.5	27.5	13	24	31.5	27.5	13	24	41.5	37.5	13	24	41.5	37.5
0.022 "	11	21	31.5	27.5	15	26	31.5	27.5*	17	29	41.5	37.5	17	29	41.5	37.5
					13	24	41.5	37.5*								
0.033 "	13	24	31.5	27.5*	13	24	41.5	37.5								
	13	24	41.5	37.5*												
0.047 "	13	24	41.5	37.5	17	29	41.5	37.5								
0.068 "	15	26	41.5	37.5	19	32	41.5	37.5								
0.1 µF	17	29	41.5	37.5												

Neue Werte. / New values.

* Bei Bestellung bitte das gewünschte Rastermaß angeben. Wenn keine Angaben erfolgen, wird grundsätzlich das kleinere RM geliefert.

* On ordering please state the required PCM (lead spacing). If not specified, smaller PCM will be booked.

* Wechselspannungen: $f \leq 1000 \text{ Hz}$; $1,4 \cdot U_{\text{eff}} \sim + U_- \leq U_N$

* AC voltage: $f \leq 1000 \text{ Hz}$; $1,4 \times U_{\text{rms}} + U_{\text{DC}} \leq U_r$

** PCM = Printed circuit module = Rastermaß/lead spacing

Die Ionisationseinsatzgrenze kann im Einzelfall unter der Wechselspannungsangabe liegen. Ionisation inception level in isolated cases may be lower than admissible rated AC voltage.

$d = 0,8 \phi$ if PCM 15 ... 27,5

$d = 1,0 \phi$ if PCM 37,5

Gegurtete Ausführung siehe Seite 93. / Taped version see page 93.

Abweichungen und Konstruktionsänderungen vorbehalten. Rights reserved to amend design data without prior notification.

Alle Maße in mm. / Dims. in mm.

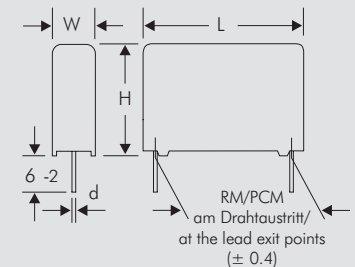

Zulässige Wechselspannung in Abhängigkeit von der Frequenz bei 10° C Eigenerwärmung (Richtwerte):
Permissible AC voltage in relation to frequency at 10° C internal temperature rise (general guide):

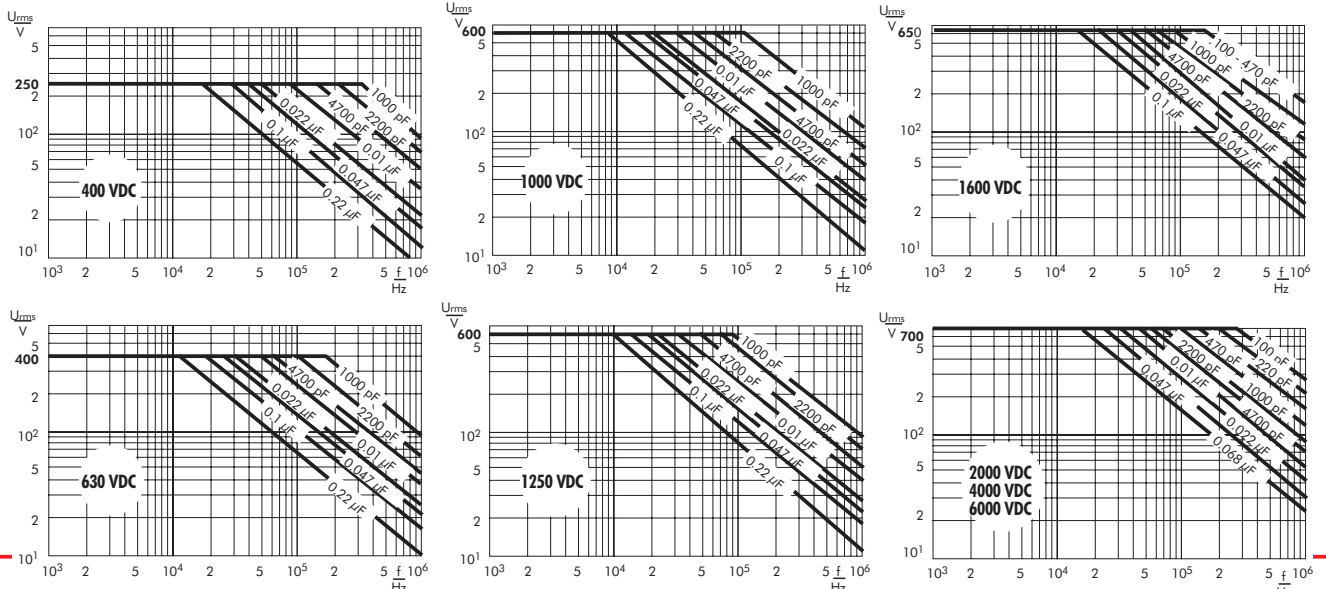

Konstruktionsarten betriebs sicherer und ausheil- fähiger Impulskondensatoren

Types of construction of operationally safe self- healing pulse capacitors

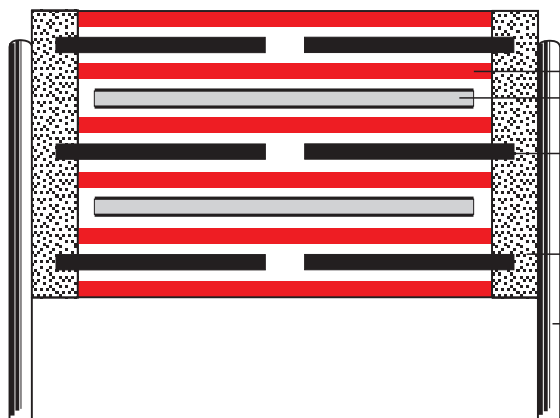

FKP 1

- Kunststofffolien-Dielektrikum
Plastic film dielectric
- Doppelseitig metallisierter Belagträger aus Kunststofffolie
Electrode carrier plastic film metallized on both sides
- Metallfolien-Beläge
Aluminium foil electrodes
- Kontaktschicht (Schoopmetall)
Metal contact layer (schoopage)
- Anschlußdraht
Terminating wire

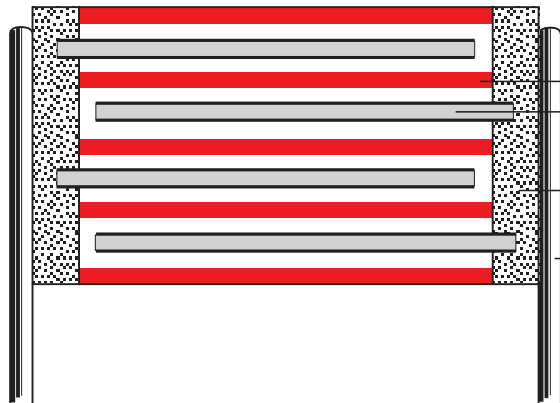

MKP 10 *

- Kunststofffolien-Dielektrikum
Plastic film dielectric
- Doppelseitig metallisierter Belagträger aus Kunststofffolie
Electrode carrier plastic film metallized on both sides
- Kontaktschicht (Schoopmetall)
Metal contact layer (schoopage)
- Anschlußdraht
Terminating wire

*MKP 10: 100 VAC, 180 VAC, 250 VAC

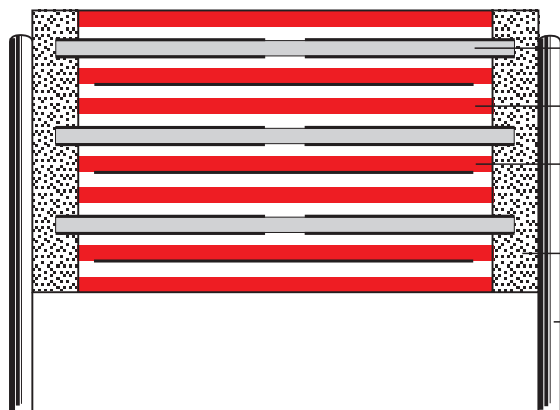

MKP 10 * Snubber MKP

- Doppelseitig metallisierter Belagträger aus Kunststofffolie
Electrode carrier plastic film metallized on both sides
- Kunststofffolien-Dielektrikum
Plastic film dielectric
- Einseitig metallisiertes Kunststofffolien-Dielektrikum
Plastic film dielectric metallized on one side
- Kontaktschicht (Schoopmetall)
Metal contact layer (schoopage)
- Anschlußdraht
Terminating wire

*MKP 10: 400 VAC, 600 VAC, 650 VAC, 700 VAC

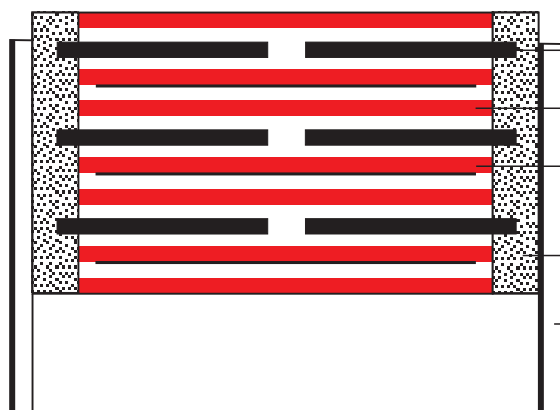

Snubber FKP

- Metallfolien-Beläge
Metal foil electrodes
- Kunststofffolien-Dielektrikum
Plastic film dielectric
- Einseitig metallisiertes Kunststofffolien-Dielektrikum
Plastic film dielectric metallized on one side
- Kontaktschicht (Schoopmetall)
Metal contact layer (schoopage)
- Anschlußblase
Terminating tab

Typical dimensions for taping configuration

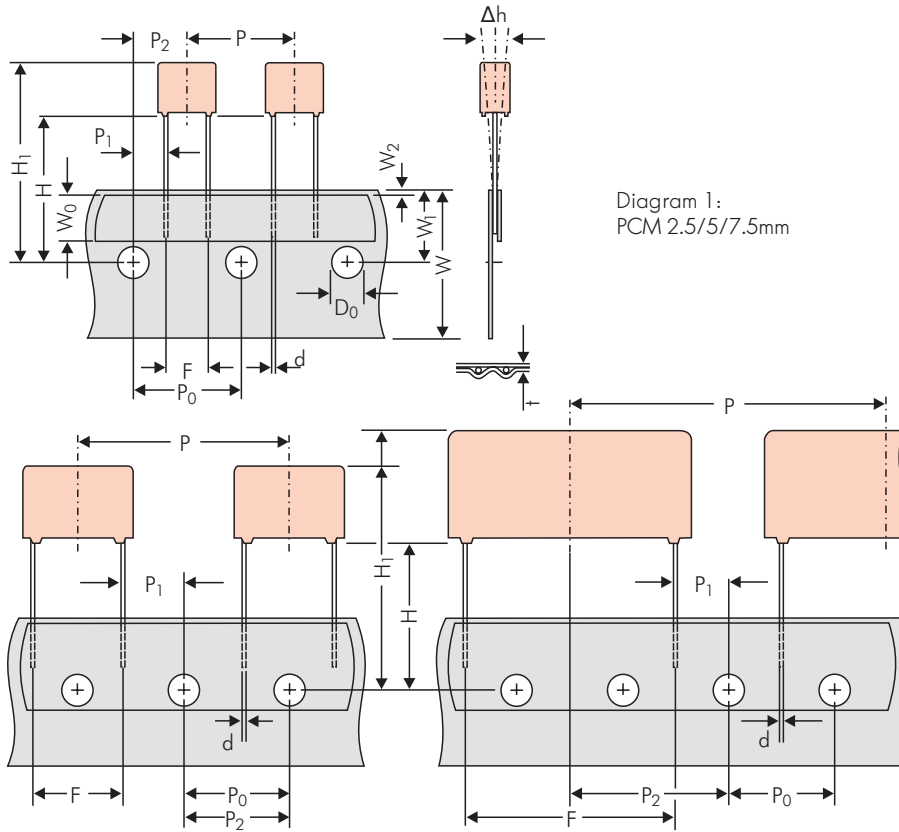

Diagram 1:
PCM 2.5/5/7.5mm

Diagram 2: PCM 10/15 mm

Diagram 3: PCM 22.5 and 27.5*mm

*PCM 27.5 taping possible with two feed holes between components

Designation	Symbol	Dimensions for radial taping							
		PCM 2.5 taping	PCM 5 taping	PCM 7.5 taping	PCM 10 taping*	PCM 15 taping*	PCM 22.5 taping	PCM 27.5 taping	
Carrier tape width	W	18.0 ±0.5	18.0 ±0.5	18.0 ±0.5	18.0 ±0.5	18.0 ±0.5	18.0 ±0.5	18.0 ±0.5	
Hold-down tape width	W ₀	6.0 for hot-sealing adhesive tape	6.0 for hot-sealing adhesive tape	12.0 for hot-sealing adhesive tape	12.0 for hot-sealing adhesive tape	12.0 for hot-sealing adhesive tape	12.0 for hot-sealing adhesive tape	12.0 for hot-sealing adhesive tape	
Hole position	W ₁	9.0 ±0.5	9.0 ±0.5	9.0 ±0.5	9.0 ±0.5	9.0 ±0.5	9.0 ±0.5	9.0 ±0.5	
Hold down tape position	W ₂	0.5 to 3.0 max.	0.5 to 3.0 max.	0.5 to 3.0 max.	0.5 to 3.0 max.	0.5 to 3.0 max.	0.5 to 3.0 max.	0.5 to 3.0 max.	
Feed hole diameter	D ₀	4.0 ±0.2	4.0 ±0.2	4.0 ±0.2	4.0 ±0.2	4.0 ±0.2	4.0 ±0.2	4.0 ±0.2	
Pitch of component	P	12.7 ±1.0	12.7 ±1.0	12.7 ±1.0	25.4 ±1.0	25.4 ±1.0	38.1 ±1.5	38.1 ±1.5 or 50.8 ±1.5	
Feed hole pitch	P ₀	12.7 ±0.3 cumulative pitch error max. 1.0 mm/20 pitch	12.7 ±0.3 cumulative pitch error max. 1.0 mm/20 pitch	12.7 ±0.3 cumulative pitch error max. 1.0 mm/20 pitch	12.7 ±0.3 cumulative pitch error max. 1.0 mm/20 pitch	12.7 ±0.3 cumulative pitch error max. 1.0 mm/20 pitch	12.7 ±0.3 cumulative pitch error max. 1.0 mm/20 pitch	12.7 ±0.3 cumulative pitch error max. 1.0 mm/20 pitch	
Feed hole centre to lead	P ₁	5.1 ±0.5	3.85 ±0.7	2.6 ±0.7	7.7 ±0.7	5.2 ±0.7	7.8 ±0.7	5.3 ±0.7	
Hole centre to component centre	P ₂	6.35 ±1.3	6.35 ±1.3	6.35 ±1.3	12.7 ±1.3	12.7 ±1.3	19.05 ±1.3	19.05 ±1.3	
Feed hole centre to bottom edge of the component	H ▲	16.5 ±0.3 18.5 ±0.5	16.5 ±0.3 18.5 ±0.5	16.5 ±0.5 18.5 ±0.5	16.5 ±0.5 18.5 ±0.5	16.5 ±0.5 18.5 ±0.5	16.5 ±0.5 18.5 ±0.5	16.5 ±0.5 18.5 ±0.5	
Feed hole centre to top edge of component	H ₁	H+H _{component} < H ₁ 32.25 max.	H+H _{component} < H ₁ 32.25 max.	H+H _{component} < H ₁ 24.5 to 31.5	H+H _{component} < H ₁ 25.0 to 31.5	H+H _{component} < H ₁ 26.0 to 37.0	H+H _{component} < H ₁ 30.0 to 43.0	H+H _{component} < H ₁ 35.0 to 45.0	
Lead spacing at upper edge of carrier tape	F	2.5 ±0.5	5.0 ^{+0.8} _{-0.2}	7.5 ±0.8	10.0 ±0.8	15 ±0.8	22.5 ±0.8	27.5 ±0.8	
Lead diameter	d	0.4 ±0.05	0.5 ±0.05	•0.5 ±0.05 or 0.7 ^{+0.07} _{-0.05}	•0.5 ±0.05 or 0.7 ^{+0.07} _{-0.05}	0.8 ^{+0.08} _{-0.05}	0.8 ^{+0.08} _{-0.05}	•0.8 ^{+0.08} _{-0.05} or 1.0 ^{+0.1} _{-0.05}	
Component alignment	Δh	± 2.0 max.	± 2.0 max.	± 3.0 max.	± 3.0 max.	± 3.0 max.	± 3.0 max.	± 3.0 max.	
Total tape thickness	t	0.7 ±0.2	0.7 ±0.2	0.7 ±0.2	0.7 ±0.2	0.7 ±0.2	0.7 ±0.2	0.7 ±0.2	
Package (see also page 15)	▲	ROLL/AMMO			AMMO				
		REEL ø 350 max. ø 30 ±1	B 52 ±2 58 ±2	depending on comp. dimensions	REEL ø 350 max. ø 30 ±1	52 ±2 B 58 ±2 or 66 ±2	REEL ø 500 max. ø 25 ±1	54 ±2 B 60 ±2 68 ±2	depending on PCM and component dimensions
Unit		see details page 93.							

▲ Please give „H“ dimensions and desired packaging type when ordering.

• Diameter of leads see General Data.

* PCM 10 and PCM 15 can be crimped to PCM 7.5.

Position of components according to PCM 7.5 (sketch 1). P₀ = 12.7 or 15.0 is possible.

Dims in mm.

Please clarify customer-specific deviations with the manufacturer.

Gurt-Verpackungsarten für Kondensatoren mit radialen Anschlüssen

Types of tape packaging of capacitors for automatic radial insertion

■ Rollenverpackung ROLL ROLL packaging

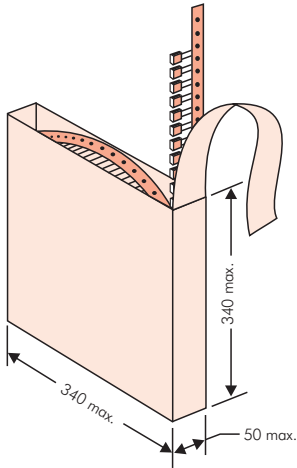

■ Lagenverpackung AMMO AMMO packaging

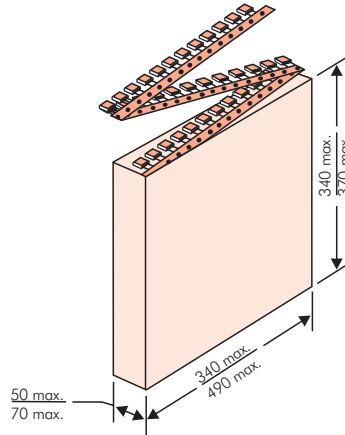

■ Trommelverpackung REEL REEL packaging

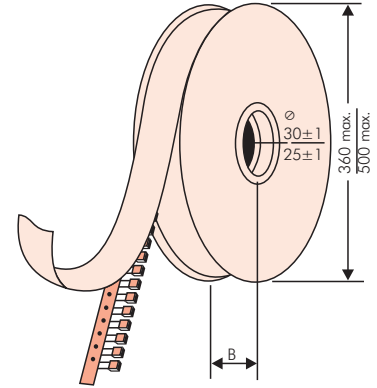

BAR CODE







Etikettierung der Verpackungseinheiten klartextlich und mit alphanumerischem Strichcode

Scanner-Decodierung von

- WIMA-Lieferernummer
- Kunden-Bestellnummer
- Kunden-Sachnummer
- WIMA-Bezeichnung
 - Artikel
 - Kapazitätswert
 - Kapazitätstoleranz
 - Nennspannung
 - Abmessungen
- WIMA-Kommissionsnummer
- Stückzahl

Zusätzlich in Klartext Lieferdatum und Kundename

BAR CODE „Code 39“

Made in Germany	
WIMA Kondensatoren/Capacitors	Werk Aurich
26.01.04-30/31	
 Lieferer-Nr. / Supplier No. (W): ...	
 Bestell-Nr. / P/O No.: ...	
 MKS-4 (1P) 2.2 µF 20% 100 V- 8 x 15 x 18 RM 15	
 Komm-Nr. / Internal P/O No.: ...	
 Sach-Nr. / Part No. (P): ...	
 Menge / Quant. (Q): ...	
Kunde / Customer: ... 26.01.04-30/31	

Labelling of package units in plain text and with alphanumerical Bar Code

Scanner decoding of

- WIMA supplier number
- Customer's P/O number
- Customer's part number
- WIMA description
 - article
 - capacitance value
 - capacitance tolerance
 - rated voltage
 - dimensions
- WIMA acknowledgement number
- Quantity

In addition date of delivery and customer's name in plain text

Mindeststückzahlen für Schüttware und EPS*

Minimum packing quantities for bulk capacitors and TPS*

Rastermaß/PCM	Bauform/Box size			Stückzahl lose pcs. per packaging unit bulk	Stückzahl/EPS* pcs. per packaging unit/TPS*	MOQ*
	W	H	L			
2.5 mm	2.5	5.5	4.6	1000	-	5000
	2.5	7	4.6	1000	-	5000
	3	7.5	4.6	1000	-	5000
	3.8	8.5	4.6	1000	-	5000
	4.6	9	4.6	1000	-	5000
	5.5	10	4.6	1000	-	5000
5 mm	2.5	5.5	7.2	1000	-	5000
	2.5	6.5	7.2	1000	-	5000
	3	7.5	7.2	1000	-	5000
	3.5	8.5	7.2	1000	-	5000
	4.5	6	7.2	500	-	5000
	4.5	8.5	7.2	500	-	5000
	4.5	9.5	7.2	500	-	5000
	5	9	7.2	500	-	5000
	5	10	7.2	500	-	5000
	5.5	7	7.2	500	-	5000
	5.5	11.5	7.2	500	-	5000
	6.5	8	7.2	500	-	5000
	7.2	8.5	7.2	500	-	5000
	7.2	13	7.2	500	-	5000
	8.5	10	7.2	500	-	5000
8.5	14	7.2	500	-	5000	
7.5 mm	2.5	7	10	1000	-	5000
	3	8.5	10	500	-	5000
	4	9	10	500	-	5000
	4.5	9.5	10.3	500	-	5000
	5	10.5	10.3	500	-	5000
	5.7	12.5	10.3	300	-	5000
10 mm	3	9	13	500	-	2000
	4	8.5	13.5	1000	-	2000
	4	9	13	300	-	2000
	4	9.5	13	300	-	2000
	5	10	13.5	1000	-	2000
	5	11	13	250	-	2000
	6	12	13	200	-	2000
	6	12.5	13	200	-	2000
15 mm	4	10	18	250	-	2000
	5	11	18	200	-	2000
	5	13	19	1000	-	2000
	6	12.5	18	250	-	2000
	6	14	19	1000	-	2000
	7	14	18	200	-	1000
	7	15	19	1000	-	1000
	8	15	18	200	-	1000
	8	17	19	500	-	1000
	9	16	18	150	-	1000
10	18	19	500	-	1000	
22.5 mm	5	14	26.5	-	180	1000
	6	15	26.5	-	155	1000
	7	16.5	26.5	-	130	1000
	8	20	28	-	115	1000
	8.5	18.5	26.5	-	110	1000
	10	22	28	-	90	500
	10.5	19	26.5	-	85	500
	10.5	20.5	26.5	-	85	500
	11	21	26.5	-	85	500
	12	24	28	-	75	500
27.5 mm	9	19	31.5	-	80	500
	11	21	31.5	-	68	500
	13	24	31.5	-	56	500
	13	25	33	-	56	500
	15	26	31.5	-	48	500
	15	26	33	-	48	500
	17	29	31.5	-	44	500
	17	34.5	31.5	-	44	500
	20	32	33	-	36	500
	20	39.5	31.5	-	36	500
37.5 mm	9	19	41.5	-	60	500
	11	22	41.5	-	51	500
	13	24	41.5	-	42	500
	15	26	41.5	-	36	500
	17	29	41.5	-	33	500
	19	32	41.5	-	27	500
	20	39.5	41.5	-	27	500
24	45.5	41.5	-	21	500	

Anderungen vorbehalten / Rights reserved to amend design data.

* Einstapel-Paletten-System / Tray-Packing-System

* MOQ = Minimum Order Quantity als ein Vielfaches einer Verpackungseinheit. Muster und Anlaufserien auf Anfrage.

* MOQ = Minimum Order Quantity as a multiple of one packing unit. Samples and pre-production needs on request.

Verpackungseinheiten für gegurtete Kondensatoren mit radialen Anschlüssen

Packing units for taped capacitors with radial leads

Rastermaß/PCM	Bauform/Box size			ROLL	REEL		AMMO		MOQ*
	W	H	L		ø 360	ø 500	340 × 340	490 × 370	
2.5 mm	2.5	5.5	4.6	2200	2500	–	2800	–	5000
	2.5	7	4.6	2200	2500	–	2800	–	5000
	3	7.5	4.6	2000	2300	–	2300	–	5000
	3.8	8.5	4.6	1500	1800	–	1800	–	5000
	4.6	9	4.6	1200	1500	–	1500	–	5000
	5.5	10	4.6	900	1200	–	1200	–	5000
5 mm	2.5	5.5	7.2	2200	2500	–	2800	–	5000
	2.5	6.5	7.2	2200	2500	–	2800	–	5000
	3	7.5	7.2	2000	2300	–	2300	–	5000
	3.5	8.5	7.2	1600	2000	–	2000	–	5000
	4.5	6	7.2	1300	1500	–	1500	–	5000
	4.5	8.5	7.2	1300	1500	–	1500	–	5000
	4.5	9.5	7.2	1300	1500	–	1500	–	5000
	5	9	7.2	1100	1400	–	1400	–	5000
	5	10	7.2	1100	1400	–	1400	–	5000
	5.5	7	7.2	1000	1200	–	1200	–	5000
	5.5	11.5	7.2	1000	1200	–	1200	–	5000
	6.5	8	7.2	800	1000	–	1000	–	5000
	7.2	8.5	7.2	700	1000	–	1000	–	5000
	7.2	13	7.2	700	950	–	1000	–	5000
	8.5	10	7.2	600	800	–	800	–	5000
8.5	14	7.2	600	800	–	800	–	5000	
7.5 mm	2.5	7	10	–	2500	4400	2500	–	5000
	3	8.5	10	–	2200	4300	2300	4150	5000
	4	9	10	–	1700	3200	1700	3100	5000
	4.5	9.5	10.3	–	1500	2900	1400	2800	5000
	5	10.5	10.3	–	1300	2500	1300	–	5000
	5.7	12.5	10.3	–	1000	2200	1100	–	5000
10 mm	3	9	13	–	1100	2200	–	1950	2000
	4	8.5	13.5	–	900	1600	–	1450	2000
	4	9	13	–	900	1600	–	1450	2000
	4	9.5	13	–	900	1600	–	1450	2000
	5	10	13.5	–	700	1300	–	1200	2000
	5	11	13	–	700	1300	–	1200	2000
	6	12	13	–	550	1100	–	1000	2000
	6	12.5	13	–	550	1100	–	1000	2000
15 mm	4	10	18	–	700	1600	–	1500	2000
	5	11	18	–	600	1200	–	1150	2000
	5	13	19	–	600	1200	–	1200	2000
	6	12.5	18	–	500	1000	–	1000	2000
	6	14	19	–	500	1000	–	1000	2000
	7	14	18	–	450	900	–	850	1000
	7	15	19	–	450	900	–	850	1000
	8	15	18	–	400	800	–	740	1000
	8	17	19	–	400	800	–	740	1000
	9	16	18	–	350	700	–	650	1000
10	18	19	–	300	650	–	590	1000	
22.5 mm	5	14	26.5	–	–	800	–	770	1000
	6	15	26.5	–	–	700	–	640	1000
	7	16.5	26.5	–	–	600	–	550	1000
	8	20	28	–	–	500	–	480	1000
	8.5	18.5	26.5	–	–	480	–	450	1000
	10	22	28	–	–	420	–	380	500
	10.5	19	26.5	–	–	400	–	360	500
	10.5	20.5	26.5	–	–	400	–	360	500
	11	21	26.5	–	–	380	–	350	500
12	24	28	–	–	350	–	310	500	
27.5 mm	9	19	31.5	–	–	460/340*	–	420	500
	11	21	31.5	–	–	380/280*	–	350	500
	13	24	31.5	–	–	300	–	290	500
	15	26	31.5	–	–	270	–	250	500

* bei 2-Zoll-Transportschritt / for 2-inch transport pitches.

Änderungen vorbehalten / Rights reserved to amend design data.

* MOQ = Minimum Order Quantity als ein Vielfaches einer Verpackungseinheit. Muster und Anlaufserien 1 Verpackungseinheit minimum.

* MOQ = Minimum Order Quantity as a multiple of one packing unit. Minimum 1 packing unit for samples and pre-production needs.